



GUIDE TO MEMORIAL DESIGNS





Horizontal Dies

APPENDIX A

Name	Length	Height	Name	Length	Height
AG-H1	48"	30"	AG-H41	32"	28"
AG-H2	36"	30"	AG-H42	36"	24"
AG-H3	30"	28"	AG-H43	36"	28"
AG-H4	38"	30"	AG-H44	36"	28"
AG-H5	30"	24"	AG-H45	30"	28"
AG-H6	36"	24"	AG-H46	32"	26"
AG-H7	36"	28"	AG-H47	36"	30"
AG-H8	30"	24"	AG-H48	42"	26"
AG-H9	32"	26"	AG-H49	42"	30"
AG-H10	36"	24"	AG-H50	42"	28"
AG-H11	48"	30"	AG-H51	36"	28"
AG-H12	36"	24"	AG-H52	36"	28"
AG-H13	36"	24"	AG-H53	32"	26"
AG-H14	36"	22"	AG-H54	30"	26"
AG-H15	30"	26"	AG-H55	36"	26"
AG-H16	48"	28"	AG-H56	36"	24"
AG-H17	36"	26"	AG-H57	36"	28"
AG-H18	48"	30"	AG-H58	30"	24"
AG-H19	31"	26"	AG-H59	32"	28"
AG-H20	30"	28"	AG-H60	48"	28"
AG-H21	30"	24"	AG-H61	30"	24"
AG-H22	30"	28"	AG-H62	44"	28"
AG-H23	36"	24"	AG-H63	60"	36"
AG-H24	30"	26"	AG-H64	48"	32"
AG-H25	30"	28"	AG-H65	36"	28"
AG-H26	60"	36"	AG-H66	30"	24"
AG-H27	20"	30"	AG-H67	32"	26"
AG-H28	32"	26"	AG-H68	36"	28"
AG-H29	36"	26"	AG-H69	42"	26"
AG-H30	38"	32"	AG-H70	30"	26"
AG-H31	36"	28"	AG-H71	30"	20"
AG-H32	36"	28"	AG-H72	36"	28"
AG-H33	48"	28"	AG-H73	36"	24"
AG-H34	36"	30"	AG-H74	30"	26"
AG-H35	36"	26"	AG-H75	32"	26"
AG-H36	30"	26"	AG-H76	26"	20"
AG-H37	42"	32"	AG-H77	30"	24"
AG-H38	36"	26"	AG-H78	36"	24"
AG-H39	36"	24"	AG-H79	42"	28"
AG-H40	36"	24"	AG-H80	60"	36"

APPENDIX B

Name	Length	Height	Name	Length	Height
AG-H-81	54"	34"	AG-H-121	36"	24"
AG-H-82	48"	42"	AG-H-122	30"	26"
AG-H-83	42"	36"	AG-H-123	36"	26"
AG-H-84	48"	30"	AG-H-124	30"	22"
AG-H-85	42"	36"	AG-H-125	30"	26"
AG-H-86	42"	32"	AG-H-126	30"	24"
AG-H-87	40"	34"	AG-H-127	26"	20"
AG-H-88	42"	34"	AG-H-128	48"	38"
AG-H-89	42"	30"	AG-H-129	42"	28"
AG-H-90	36"	30"	AG-H-130	42"	28"
AG-H-91	42"	30"	AG-H-131	36"	28"
AG-H-92	42"	36"	AG-H-132	42"	28"
AG-H-93	36"	30"	AG-H-133	42"	28"
AG-H-94	42"	36"	AG-H-134	36"	28"
AG-H-95	39"	33"	AG-H-135	36"	28"
AG-H-96	42"	34"	AG-H-136	36"	28"
AG-H-97	42"	36"	AG-H-137	30"	26"
AG-H-98	42"	36"	AG-H-138	28"	32"
AG-H-99	42"	36"	AG-H-139	36"	28"
AG-H-100	42"	36"	AG-H-140	24"	28"
AG-H-101	36"	36"	AG-H-141	42"	26"
AG-H-102	48"	36"	AG-H-142	40"	26"
AG-H-103	42"	36"	AG-H-143	30"	20"
AG-H-104	42"	36"	AG-H-144	30"	24"
AG-H-105	42"	36"	AG-H-145	30"	36"
AG-H-106	42"	36"	AG-H-146	28"	42"
AG-H-107	36"	28"	AG-H-147	39"	30"
AG-H-108	48"	38"	AG-H-148	36"	24"
AG-H-109	42"	34"	AG-H-149	42"	30"
AG-H-110	42"	42"	AG-H-150	24"	52"
AG-H-111	42"	36"	AG-H-151	26"	28"
AG-H-112	42"	36"	AG-H-152	42"	26"
AG-H-113	48"	32"	AG-H-153	60"	70"
AG-H-114	44"	34"	AG-H-154	28"	52"
AG-H-115	42"	30"	AG-H-155	54"	48"
AG-H-116	30"	30"	AG-H-156	24"	48"
AG-H-117	32"	24"	AG-H-157	60"	30"
AG-H-118	36"	26"	AG-H-158	44"	28"
AG-H-119	36"	24"	AG-H-159	36"	26"
AG-H-120	36"	28"	AG-H-160	30"	26"

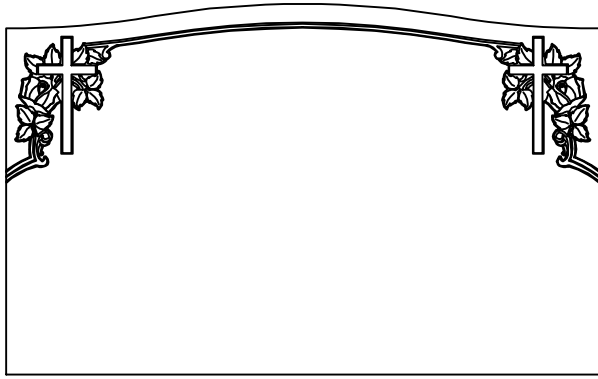

AG-H-01

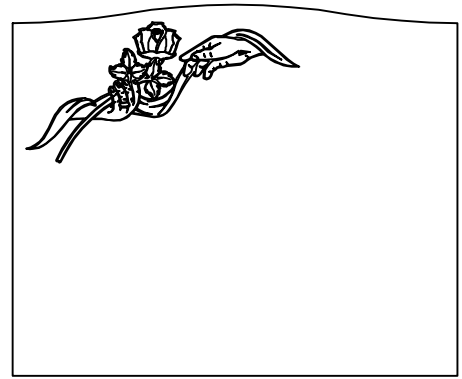

AG-H-02

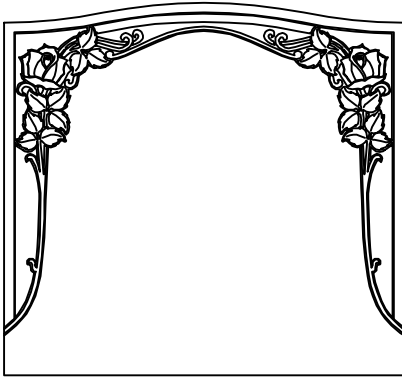

AG-H-03

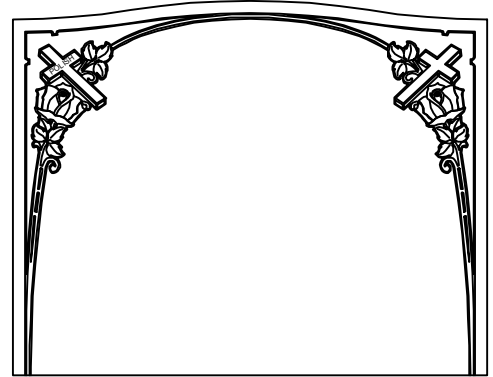

AG-H-04

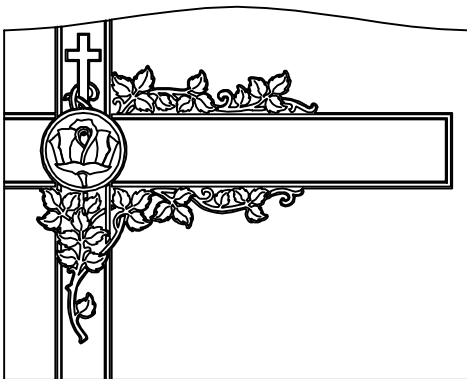

AG-H-05

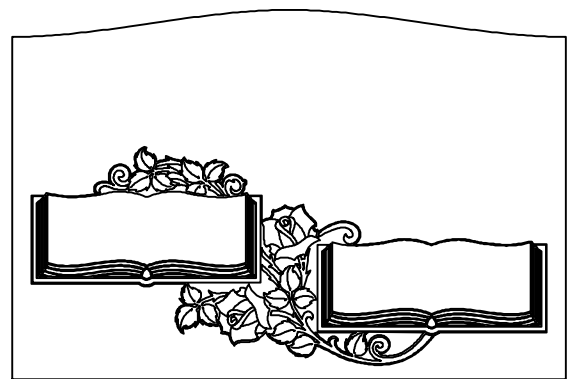

AG-H-06

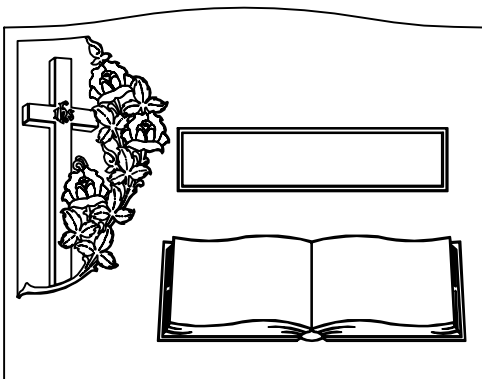

AG-H-07

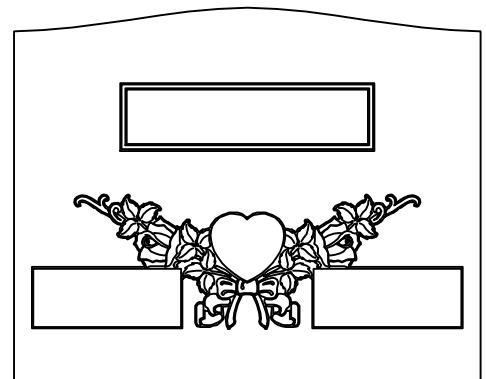

AG-H-08

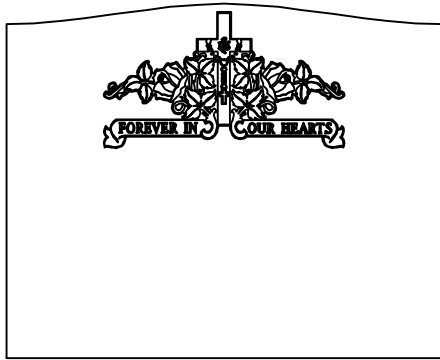

AG-H-09

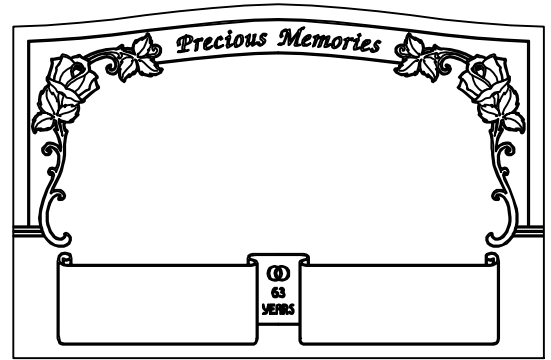

AG-H-10

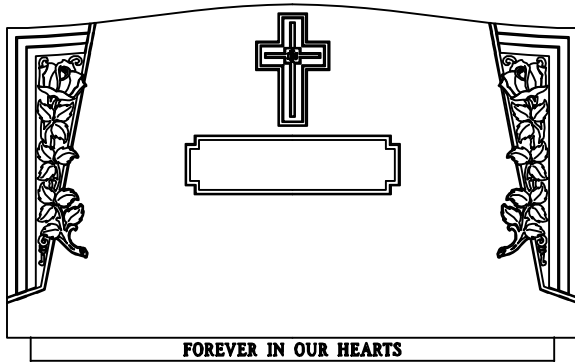

AG-H-11

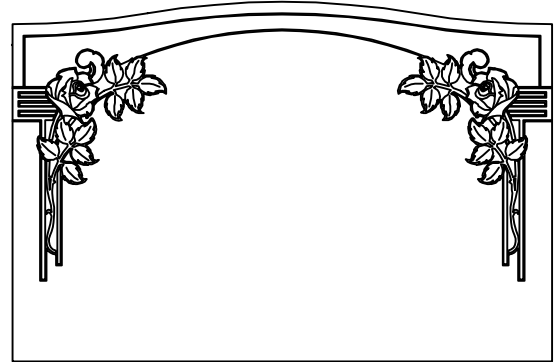

AG-H-12

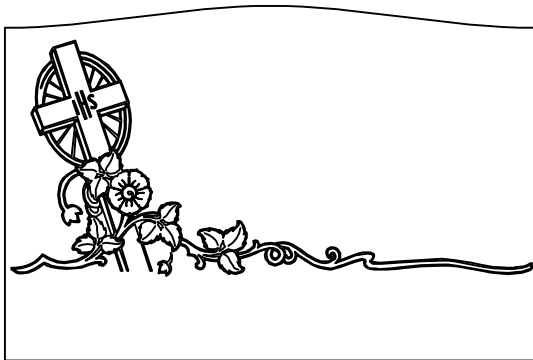

AG-H-13

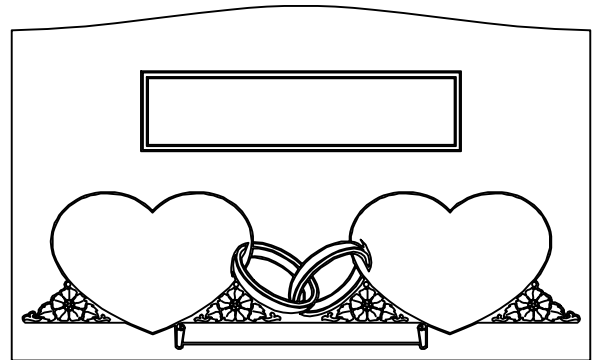

AG-H-14

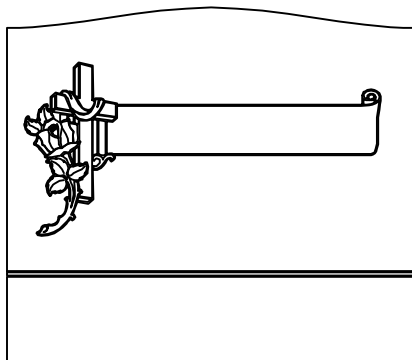

AG-H-15

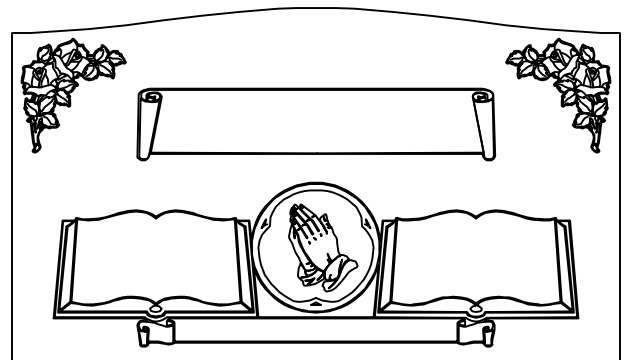

AG-H-16

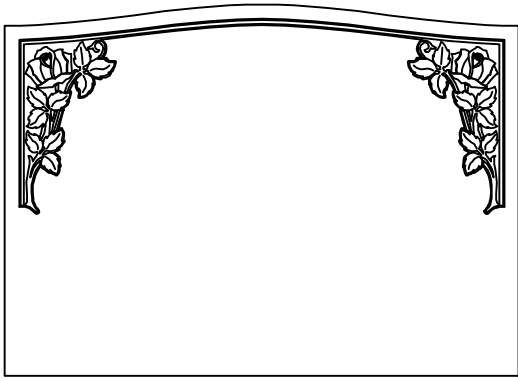

AG-H-7

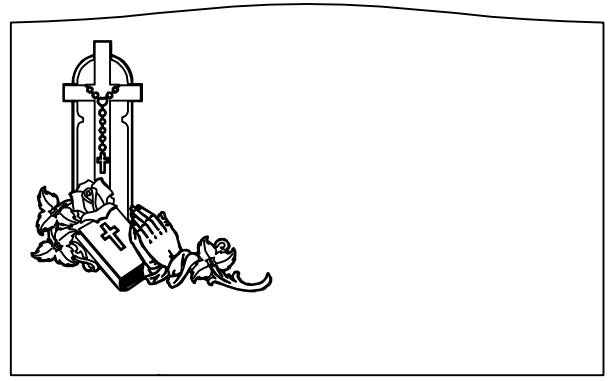

AG-H-8

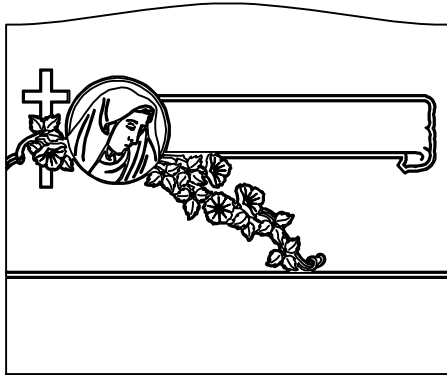

AG-H-9

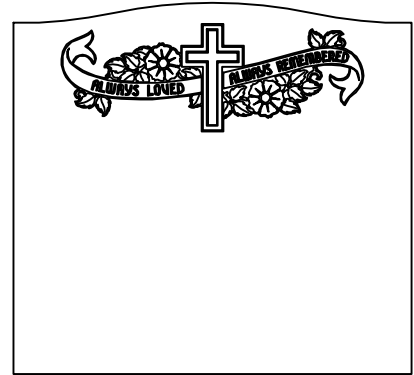

AG-H-20

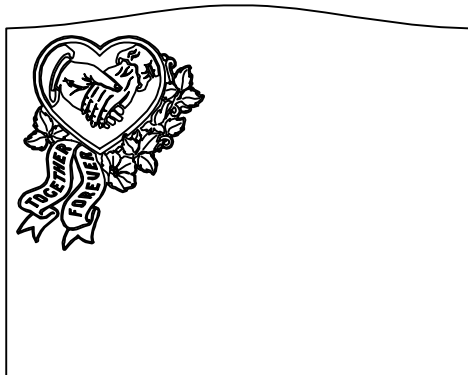

AG-H-21

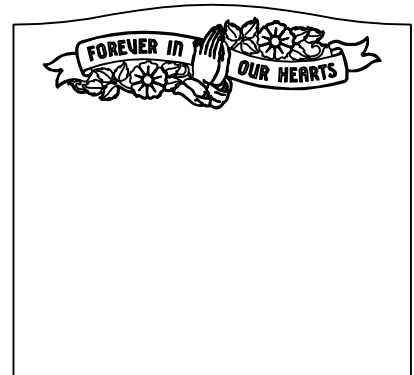

AG-H-22

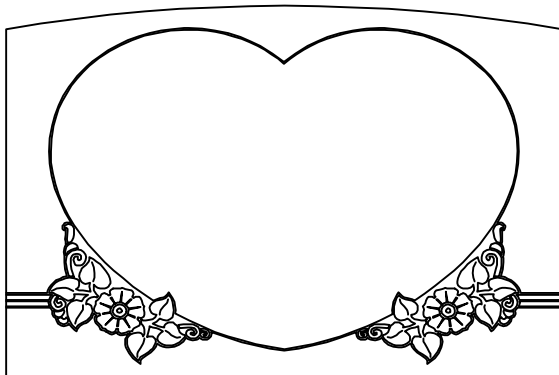

AG-H-23

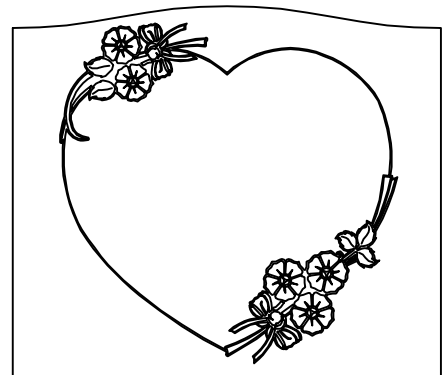

AG-H-24

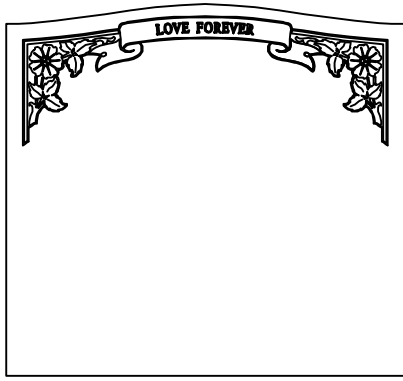

AG-H-25

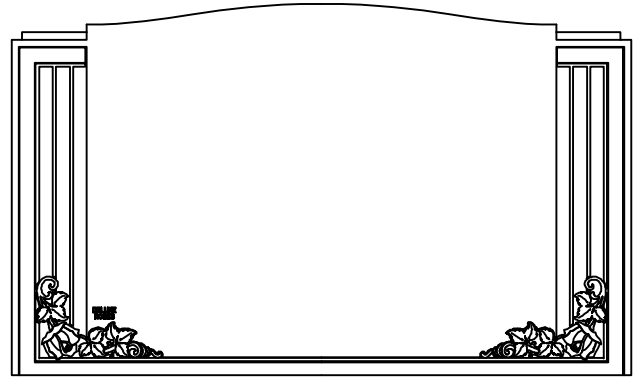

AG-H-26

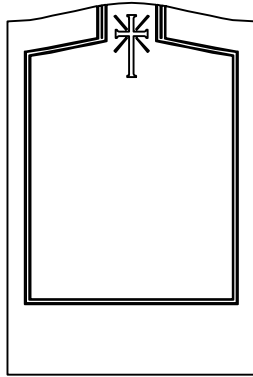

AG-H-27

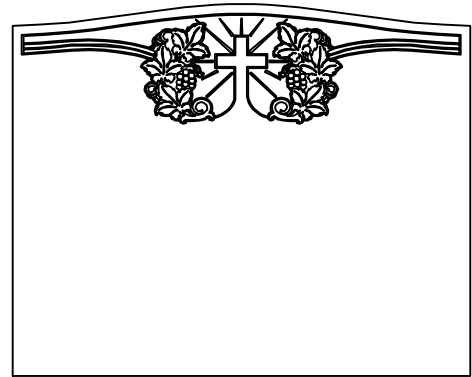

AG-H-28

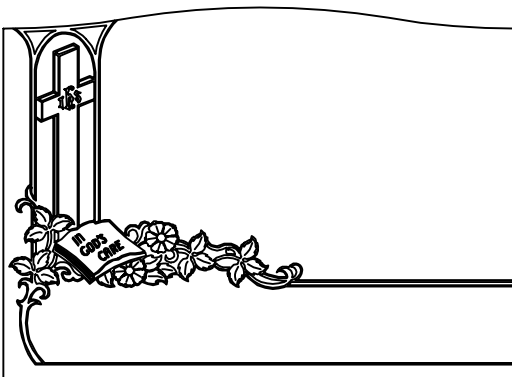

AG-H-29

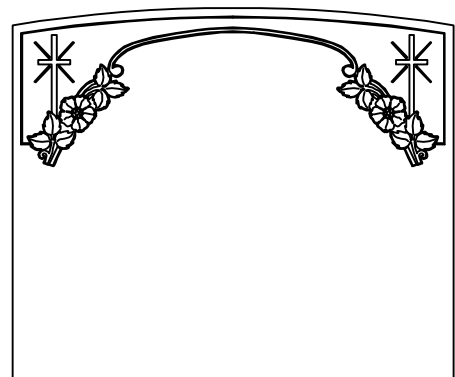

AG-H-30

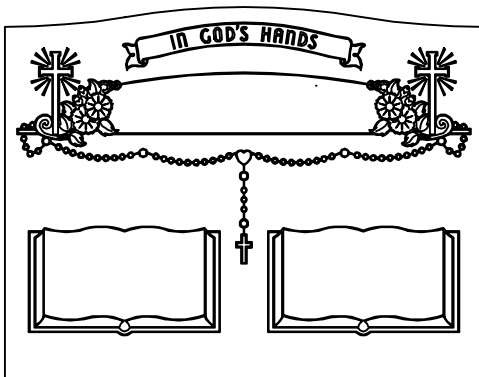

AG-H-31

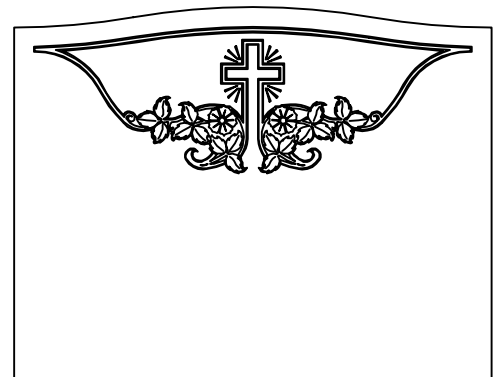

AG-H-32

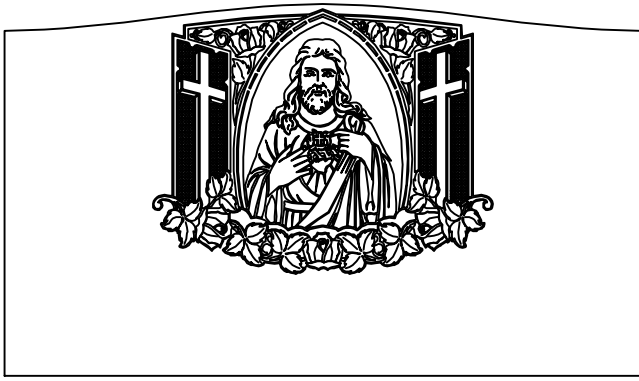

AG-H-33

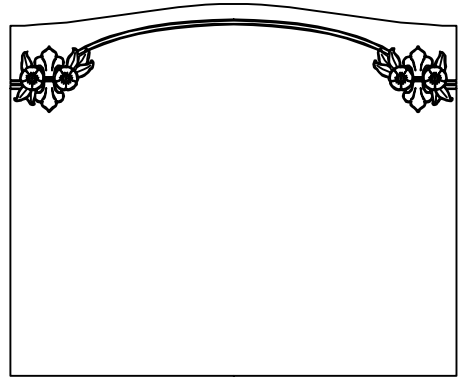

AG-H-34

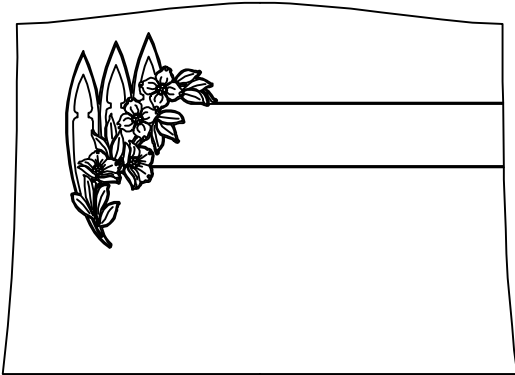

AG-H-35

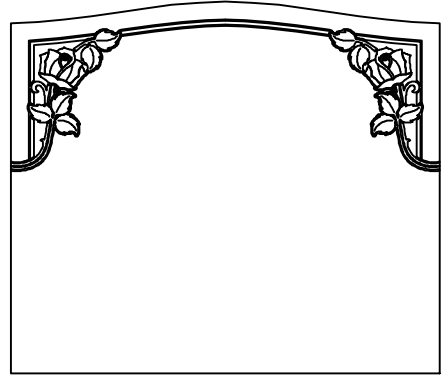

AG-H-36

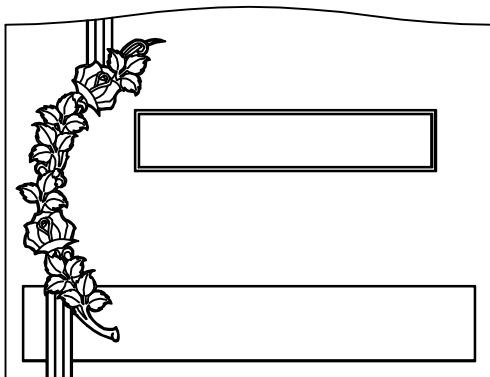

AG-H-37

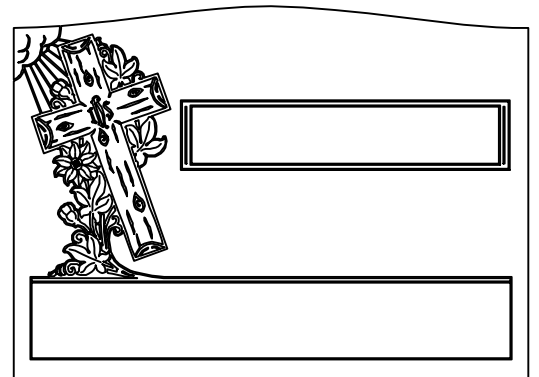

AG-H-38

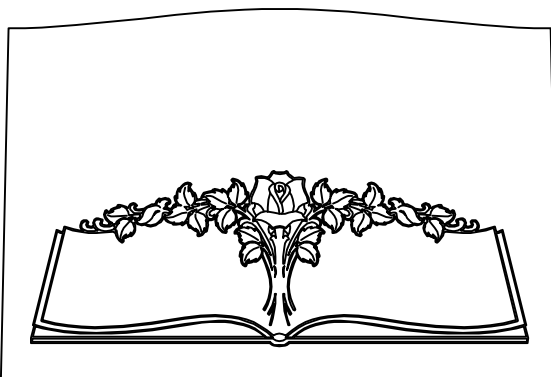

AG-H-29

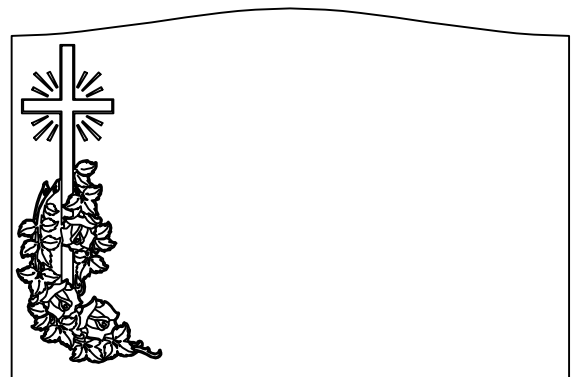

AG-H-40

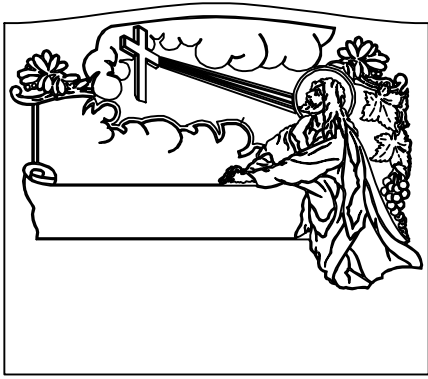

AG-H-41

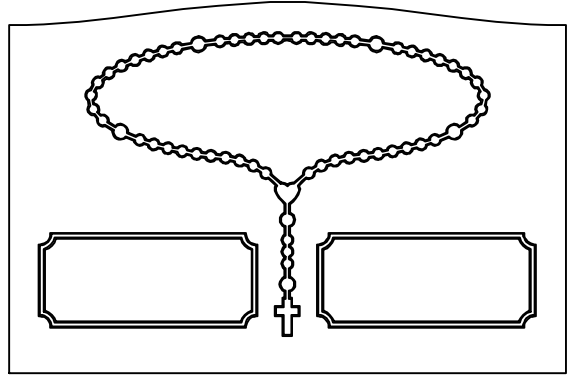

AG-H-42

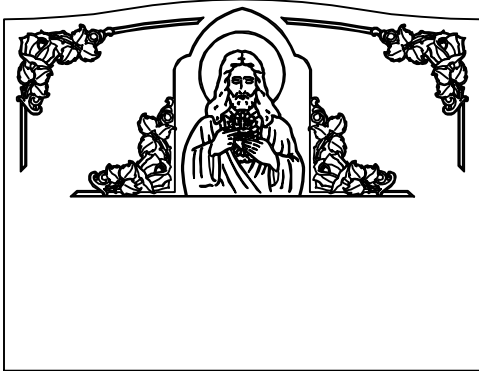

AG-H-43

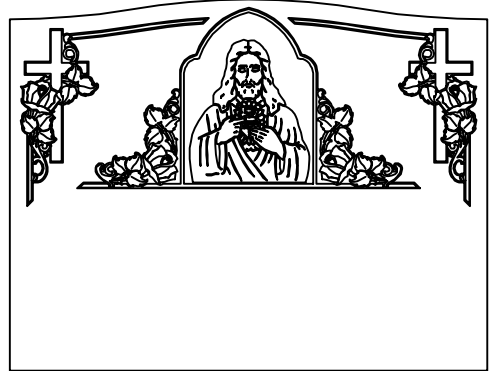

AG-H-44

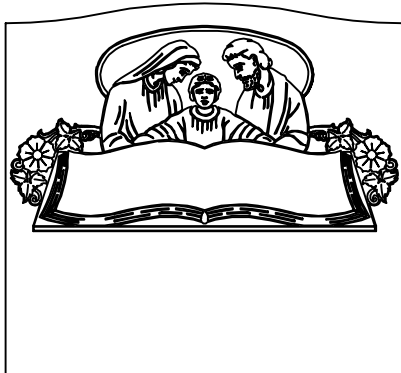

AG-H-45

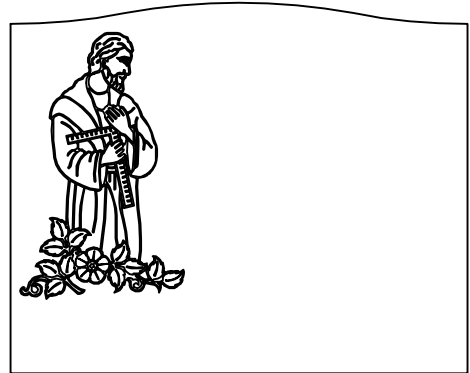

AG-H-46

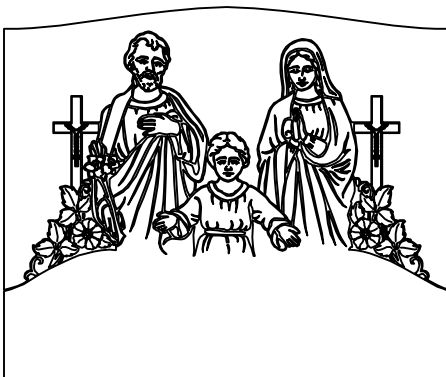

AG-H-47

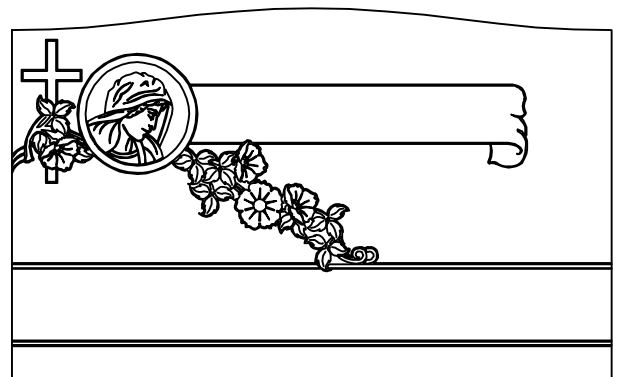

AG-H-48

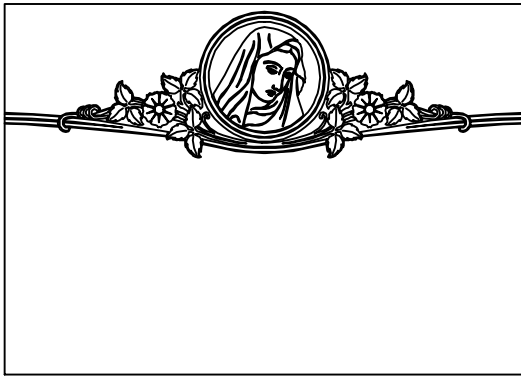

AG-H-49



AG-H-50

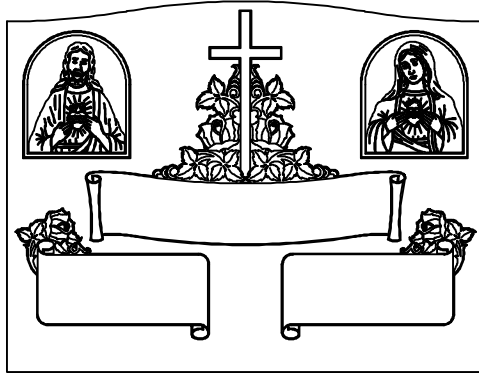

AG-H-51

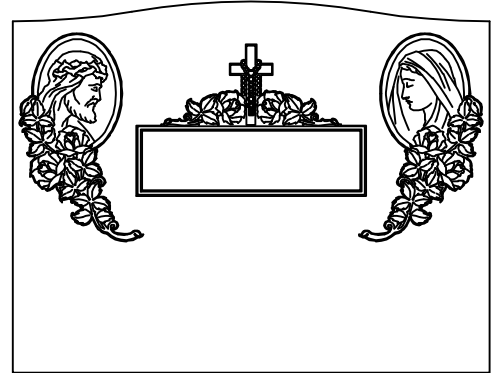

AG-H-52

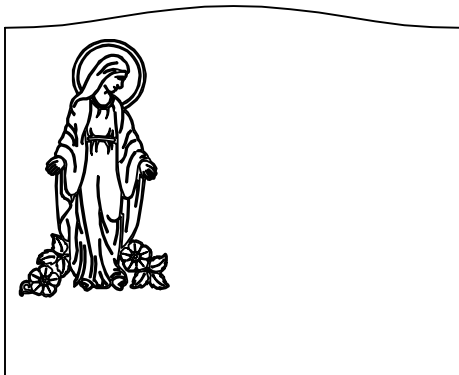

AG-H-53



AG-H-54

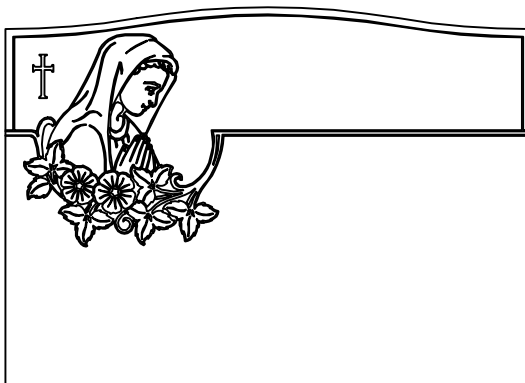

AG-H-55

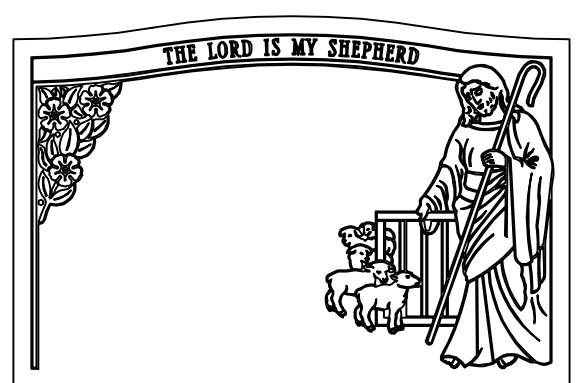

AG-H-56

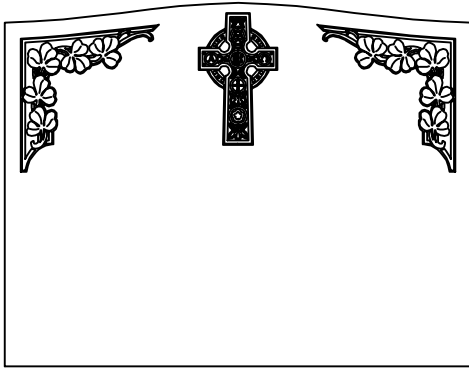

AG-H-57

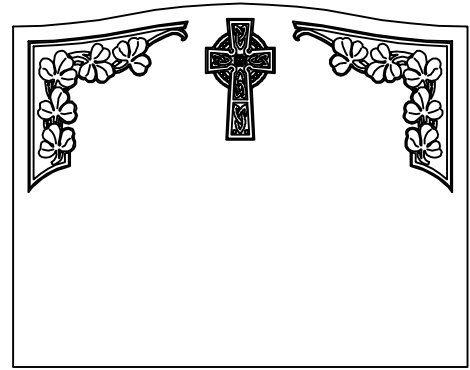

AG-H-58

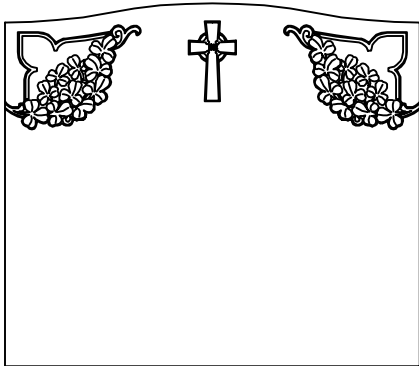

AG-H-59

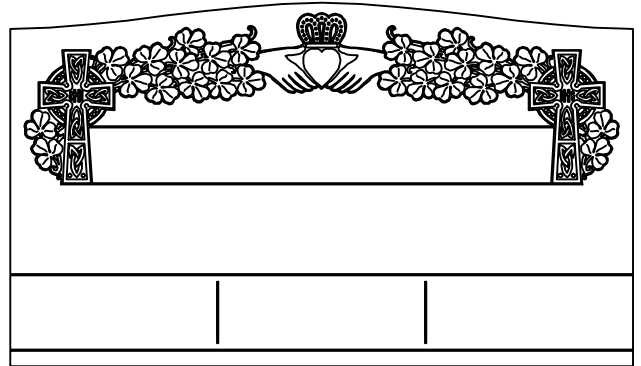

AG-H-60

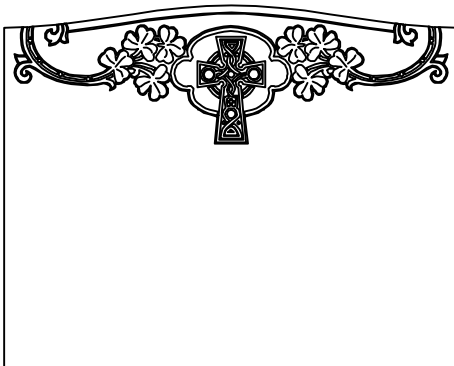

AG-H-61

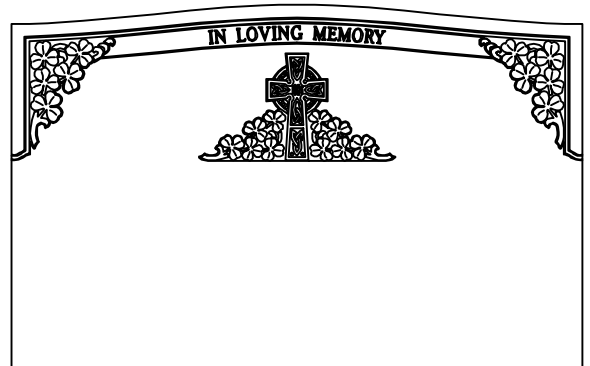

AG-H-62

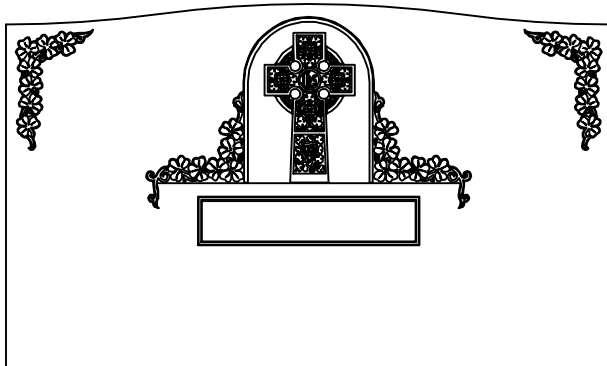

AG-H-63

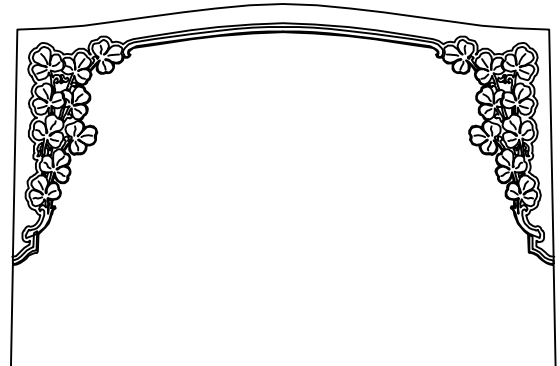

AG-H-64

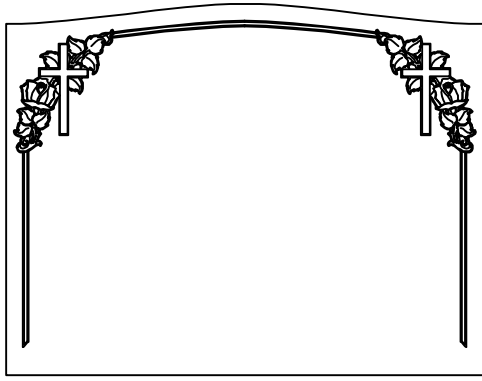

AG-H-65

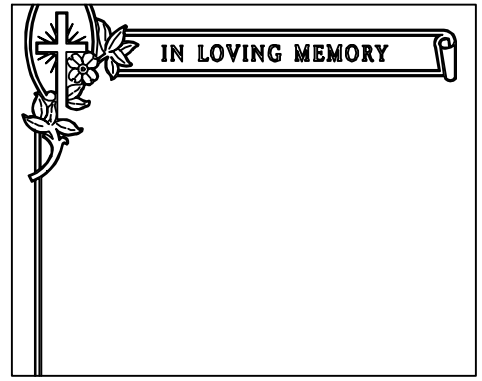

AG-H-66

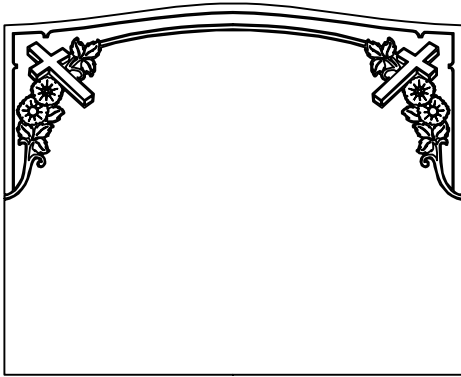

AG-H-67

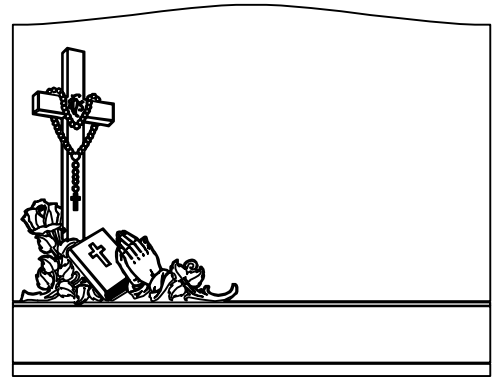

AG-H-68

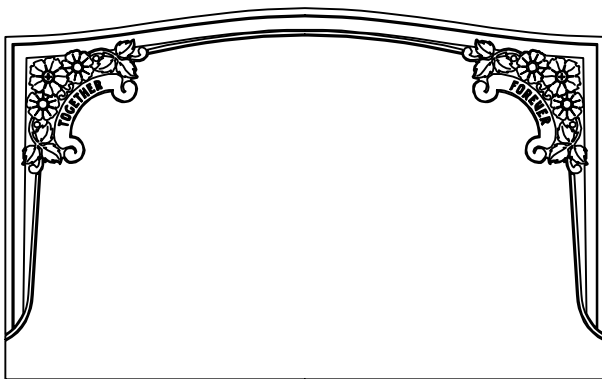

AG-H-69

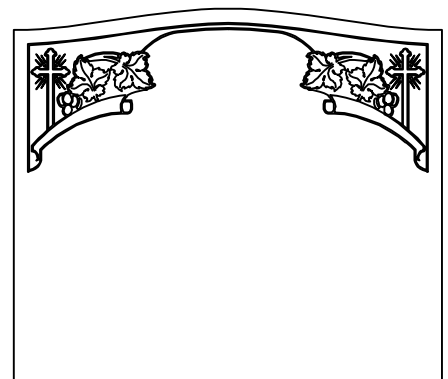

AG-H-70

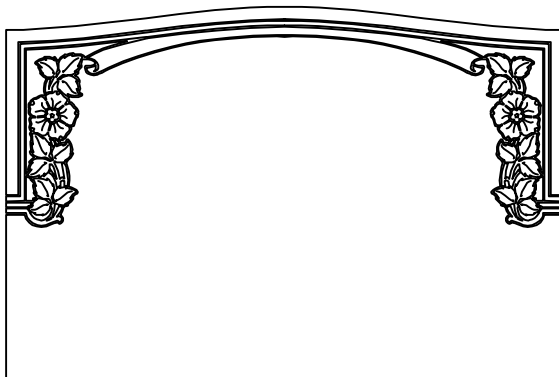

AG-H-71

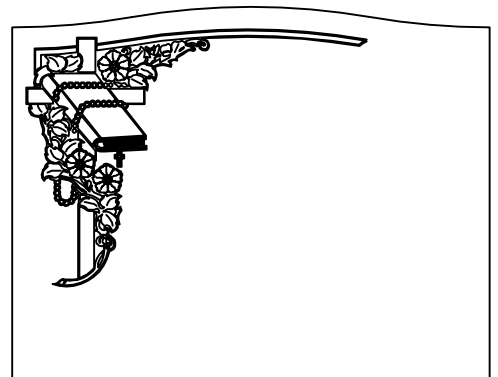

AG-H-72

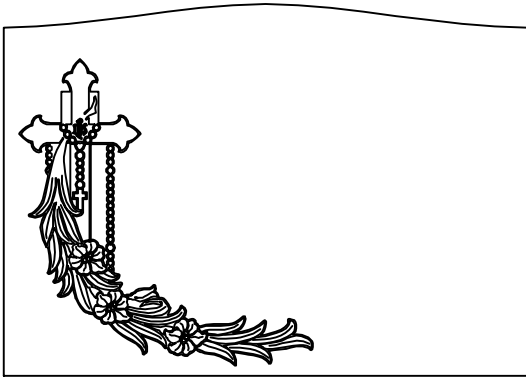

AG-H-73

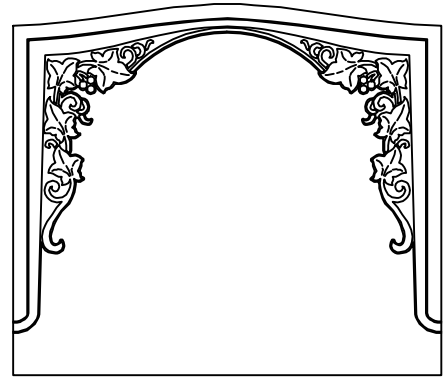

AG-H-74

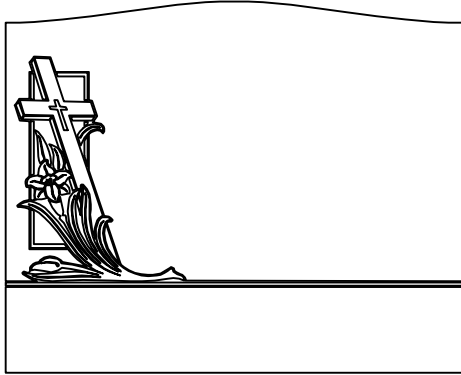

AG-H-75

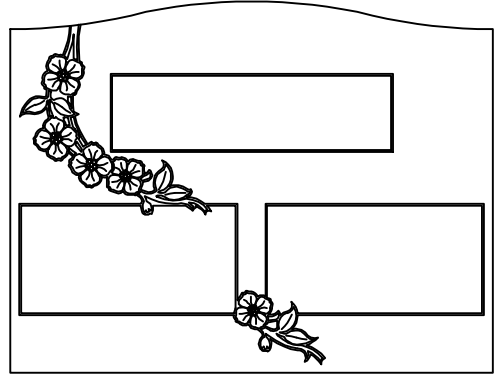

AG-H-76

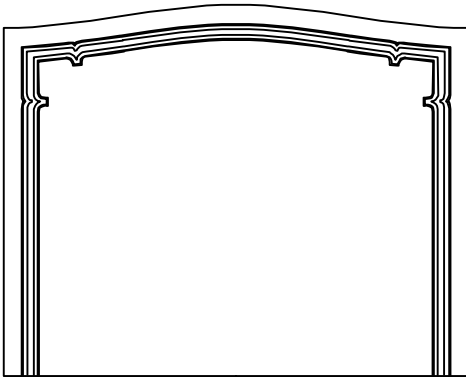

AG-H-77

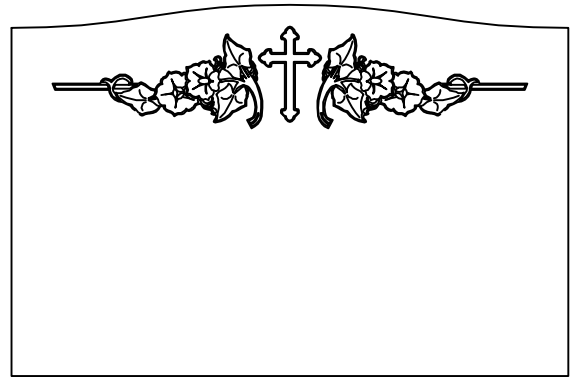

AG-H-78

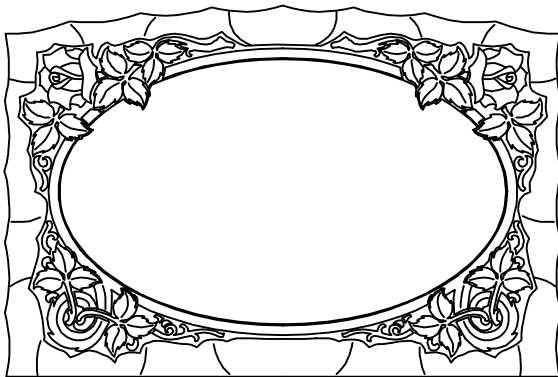

AG-H-79

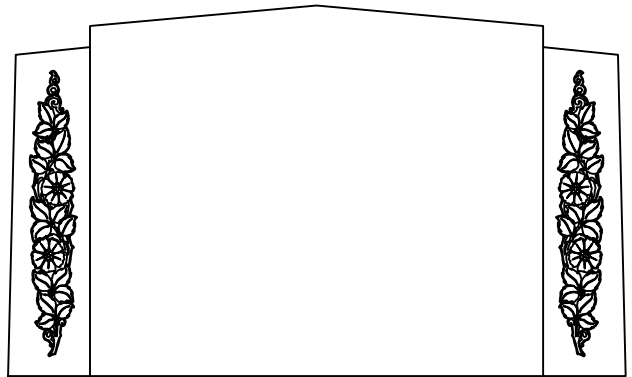

AG-H-80

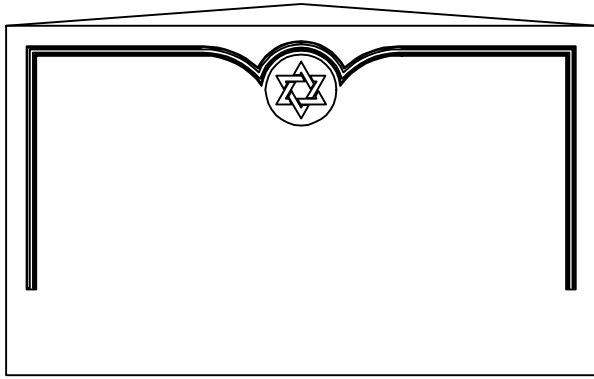

AG-H-81

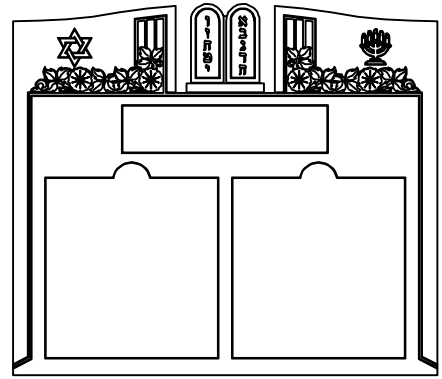

AG-H-82

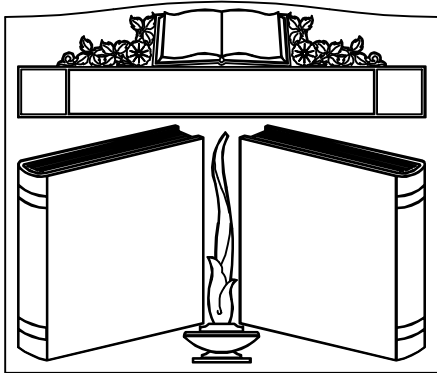

AG-H-83

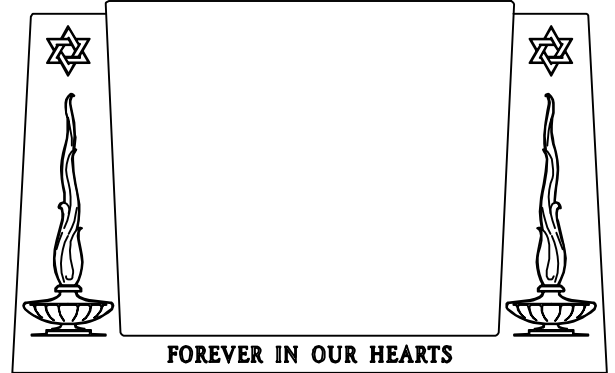

FOREVER IN OUR HEARTS

AG-H-84

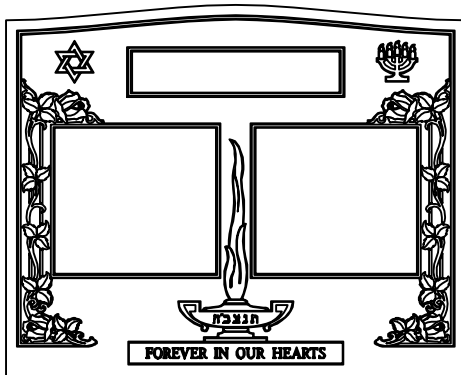

FOREVER IN OUR HEARTS

AG-H-85

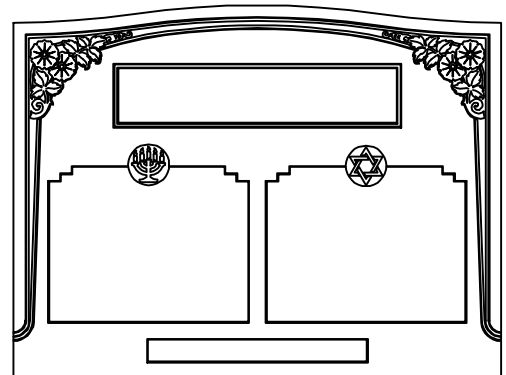

AG-H-86

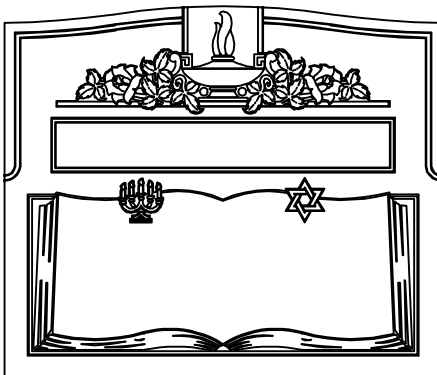

AG-H-87

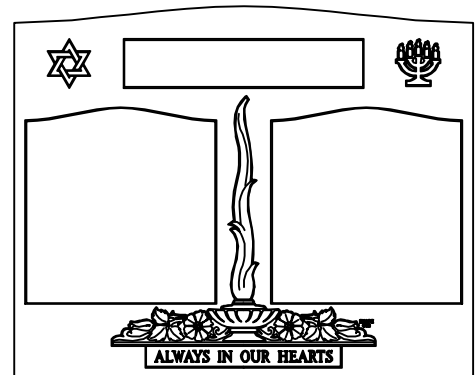

ALWAYS IN OUR HEARTS

AG-H-88

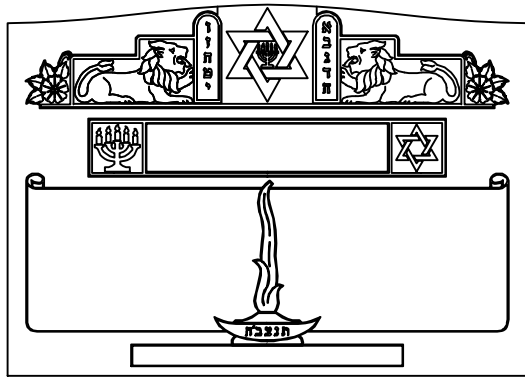

AG-H-89

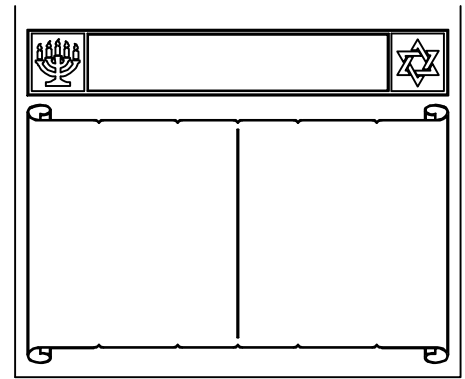

AG-H-90

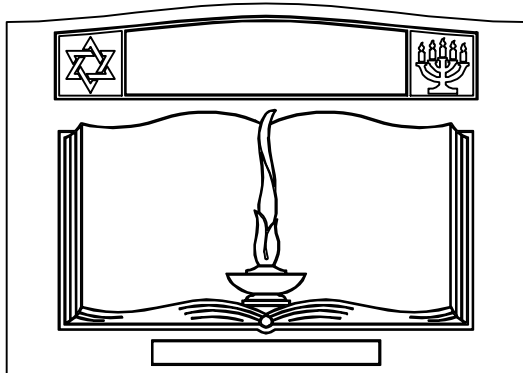

AG-H-91

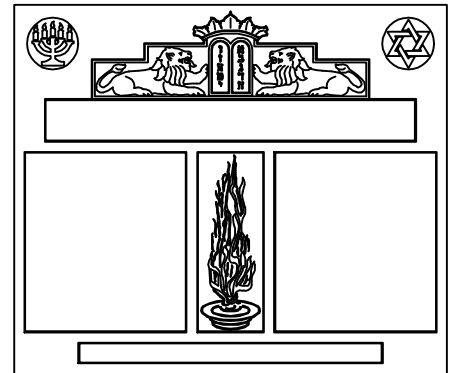

AG-H-92

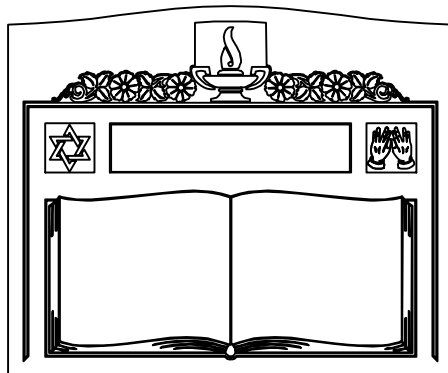

AG-H-93

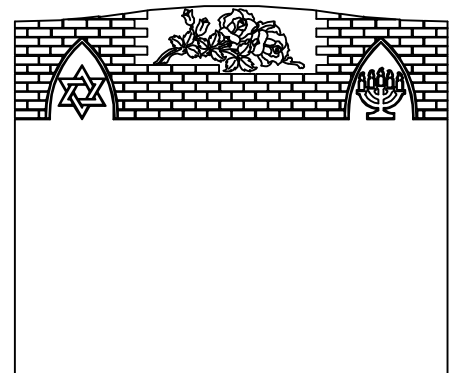

AG-H-94

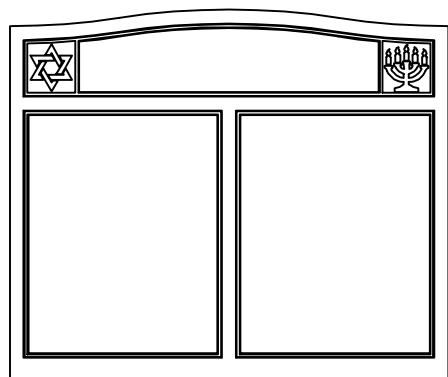

AG-H-95

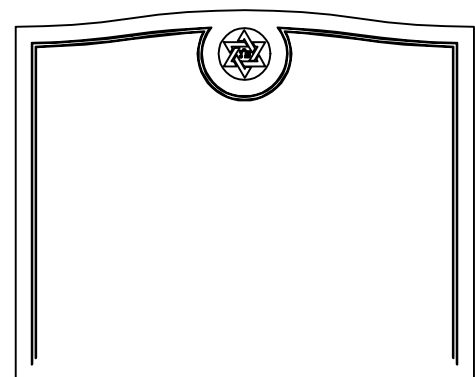

AG-H-96

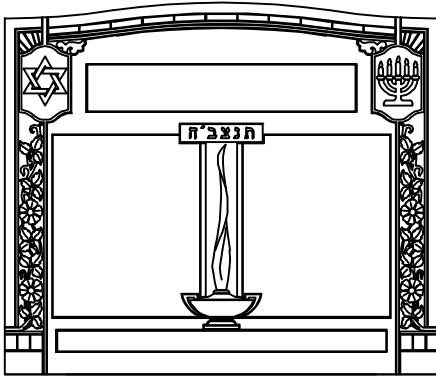

AG-H-97

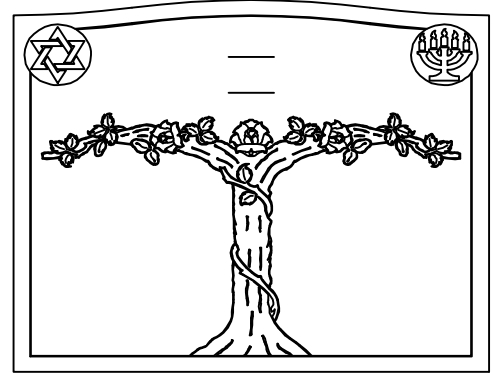

AG-H-98

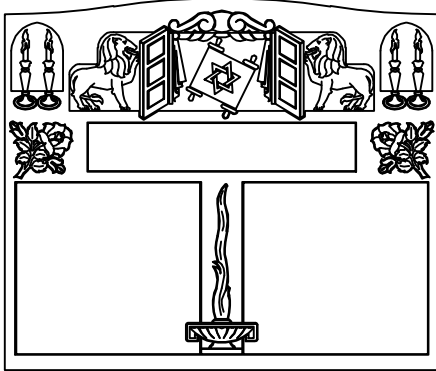

AG-H-99

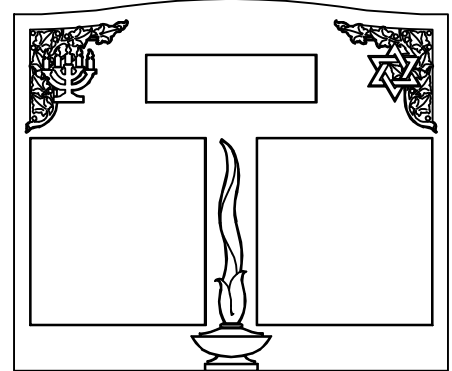

AG-H-100

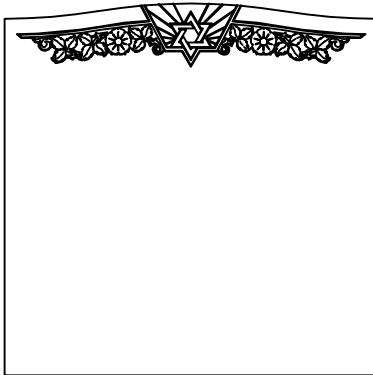

AG-H-101

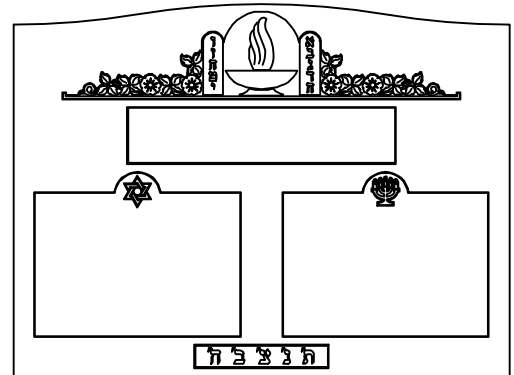

AG-H-102

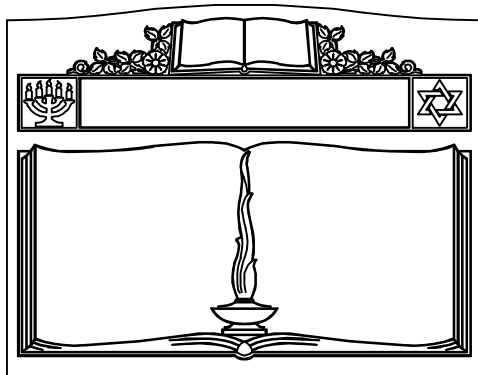

AG-H-103

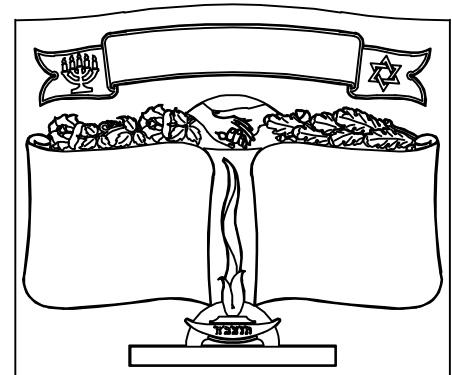

AG-H-104

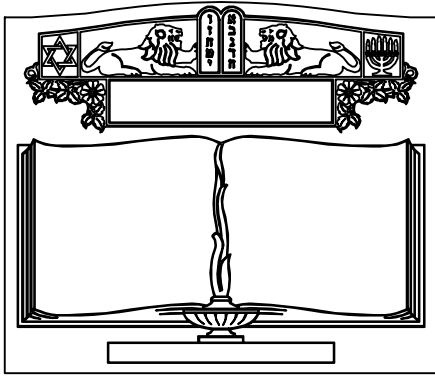

AG-H105

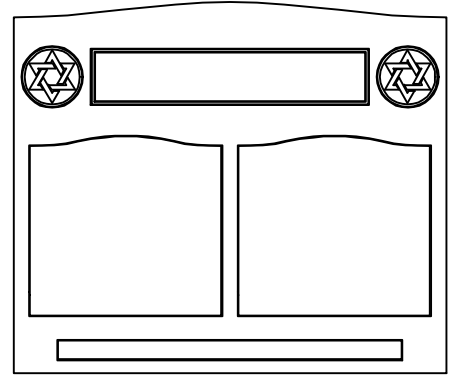

AG-H106

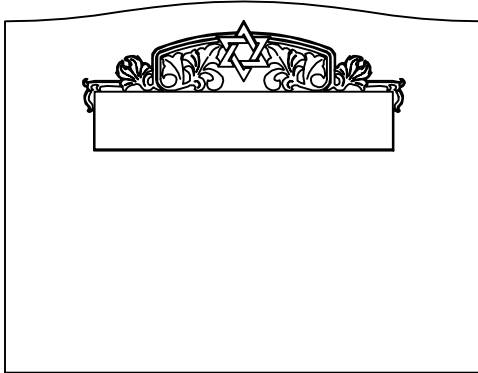

AG-H107

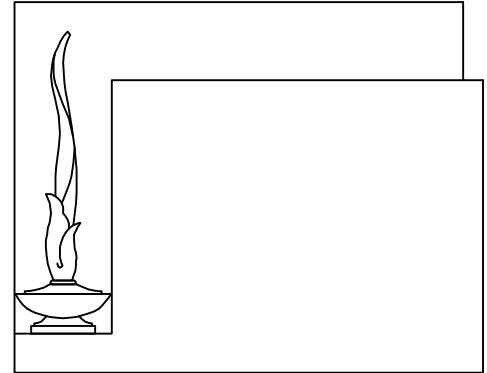

AG-H108

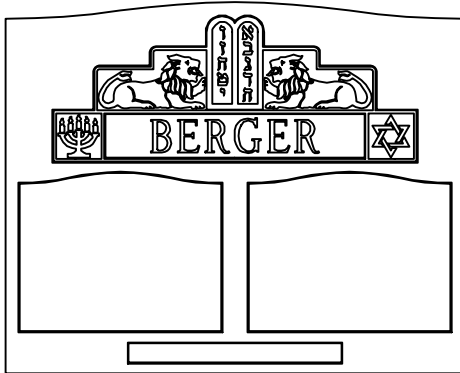

AG-H109

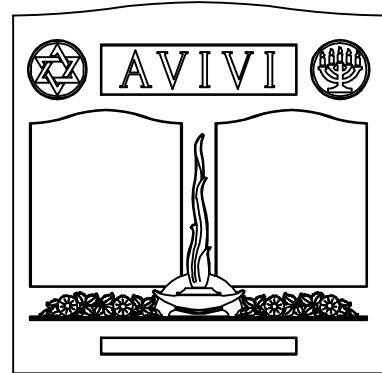

AG-H110

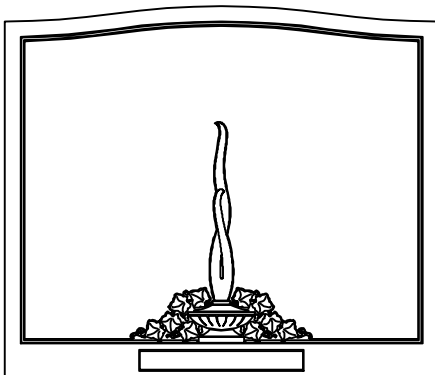

AG-H111

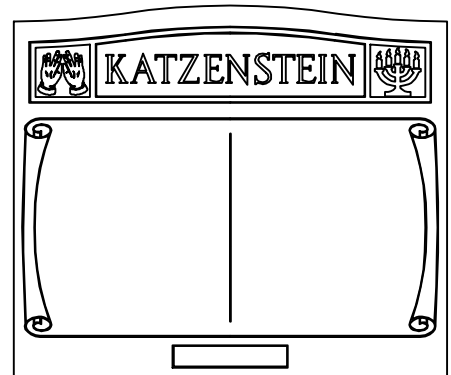

AG-H112

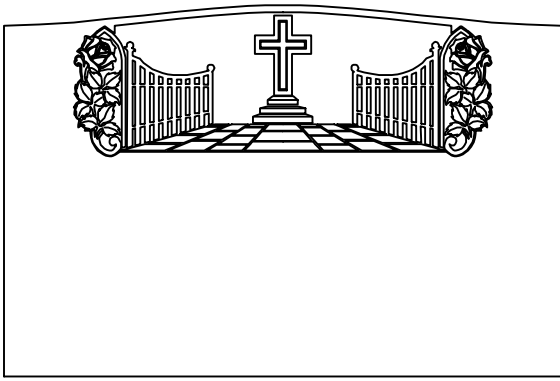

AG-H-113

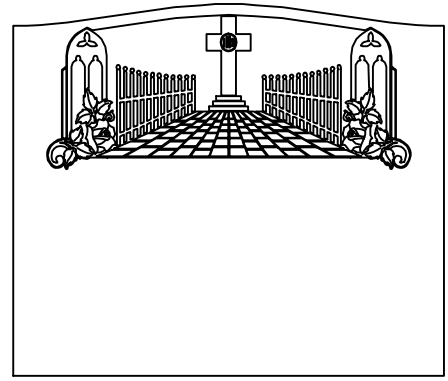

AG-H-114

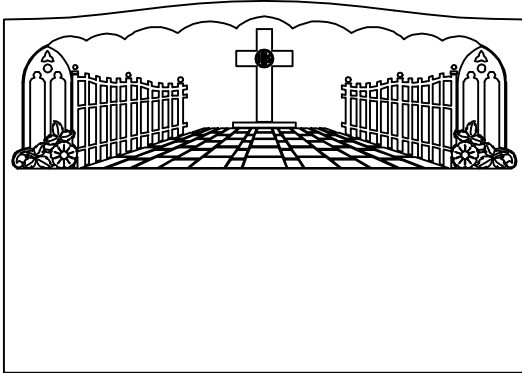

AG-H-115

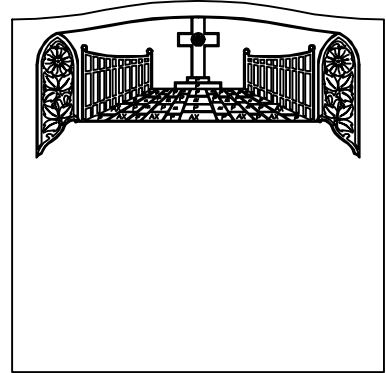

AG-H-116

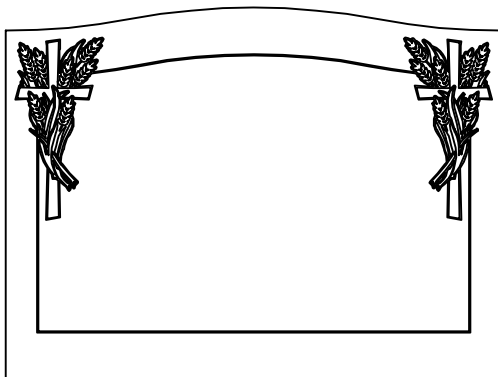

AG-H-117

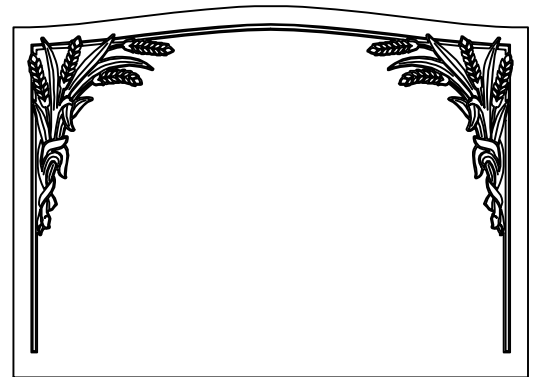

AG-H-118

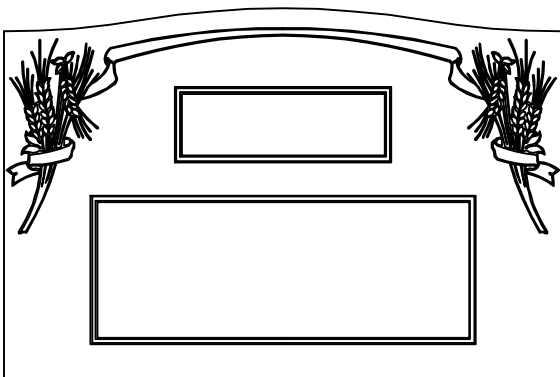

AG-H-119

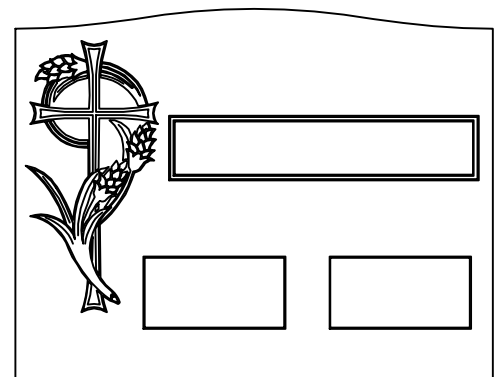

AG-H-120

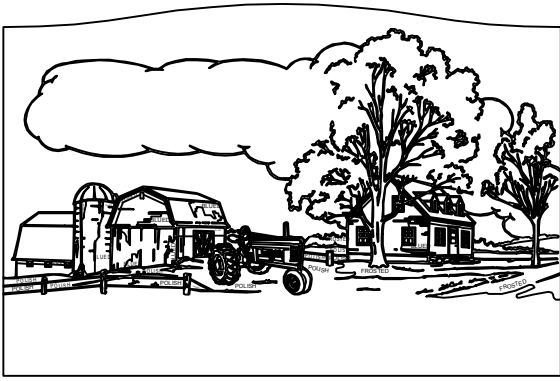

AG-H-21

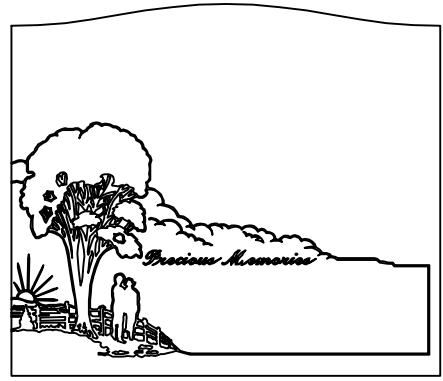

AG-H-22

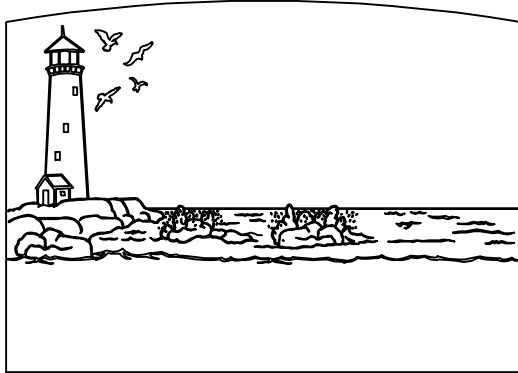

AG-H-23



AG-H-24

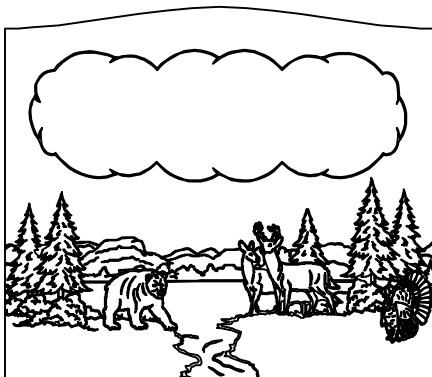

AG-H-25

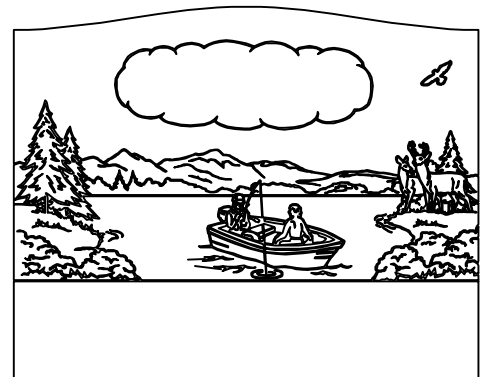

AG-H-26

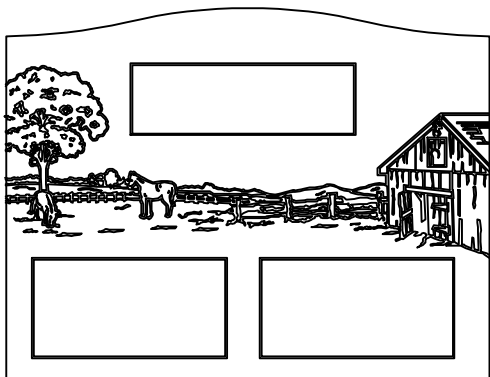

AG-H-27

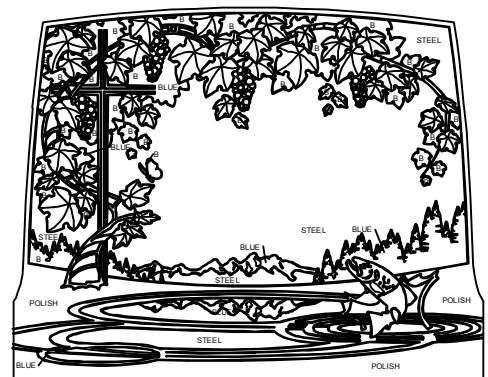

AG-H-28

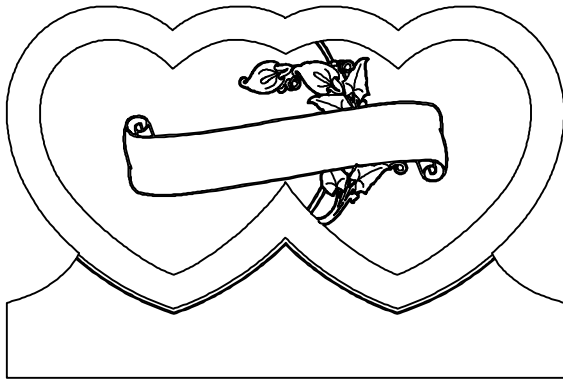

AG-H29

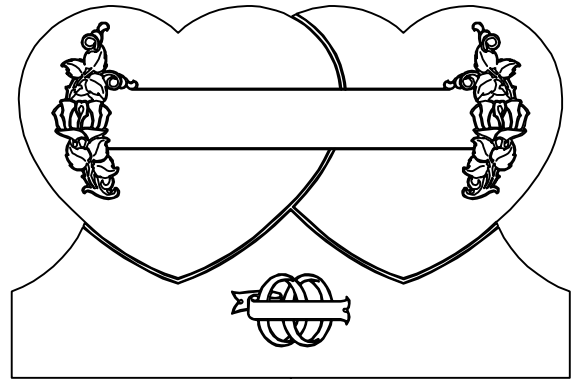

AG-H30

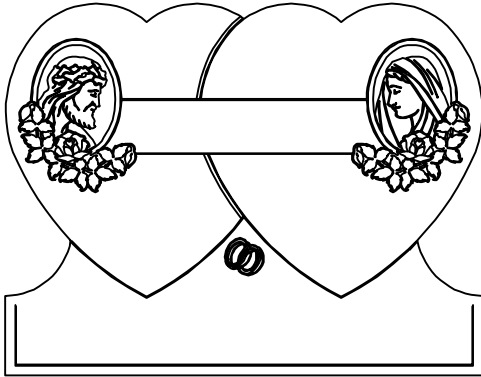

AG-H31

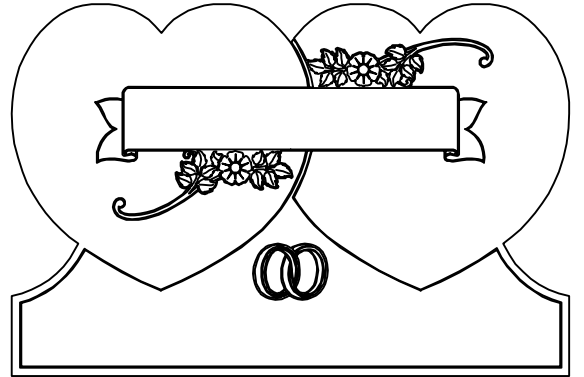

AG-H32

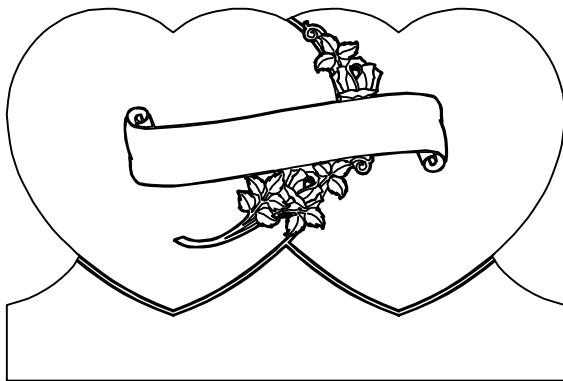

AG-H33

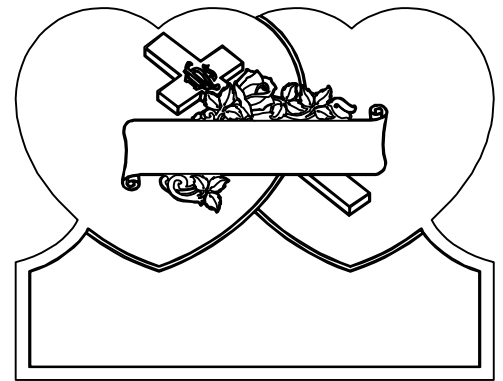

AG-H34

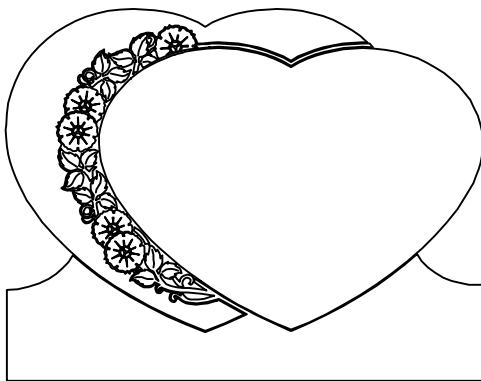

AG-H35

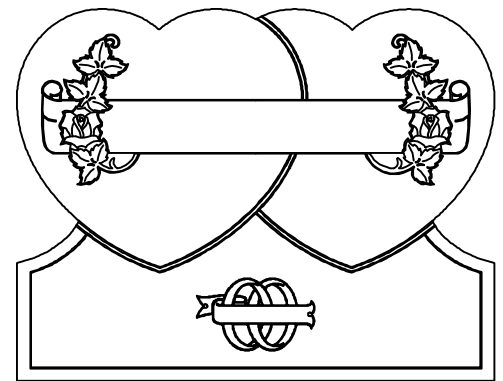

AG-H36

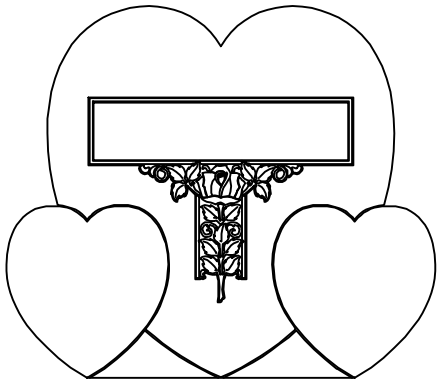

AG-H137

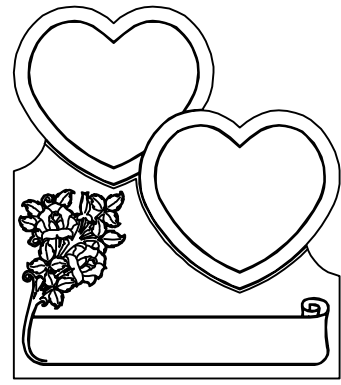

AG-H138

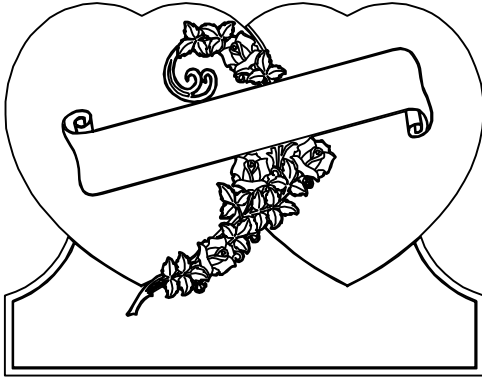

AG-H139

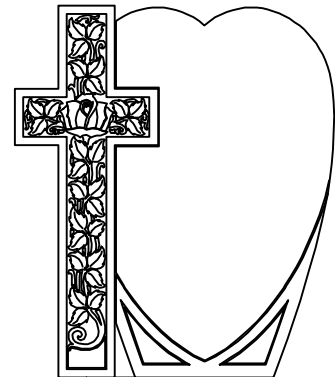

AG-H140

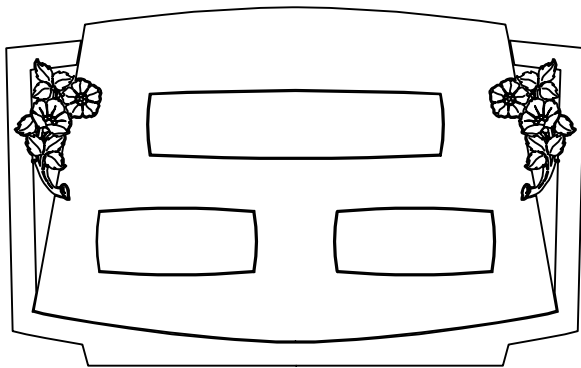

AG-H141

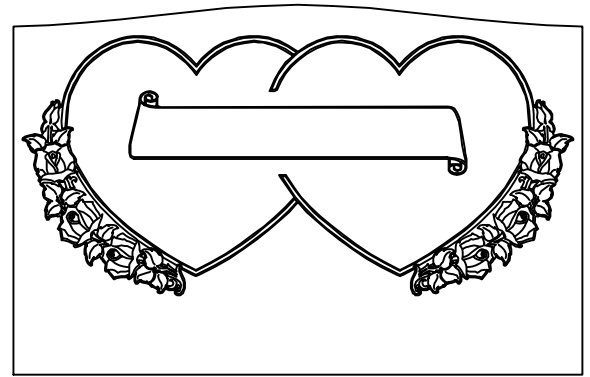

AG-H142

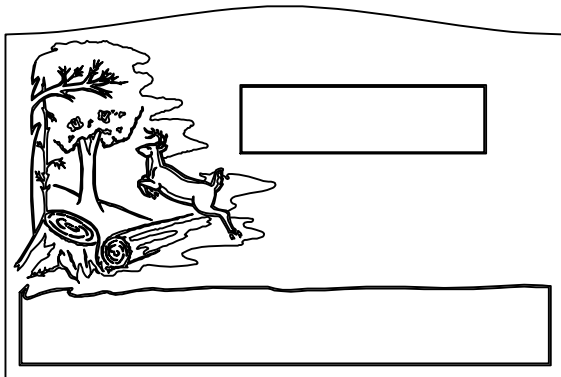

AG-H143

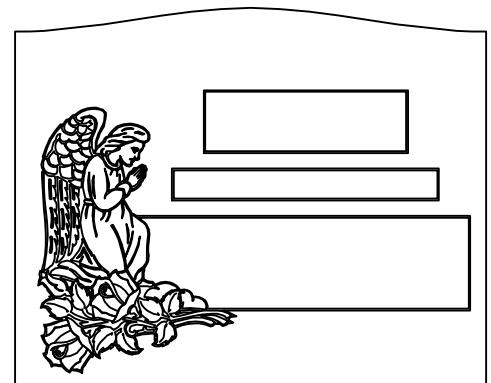

AG-H144

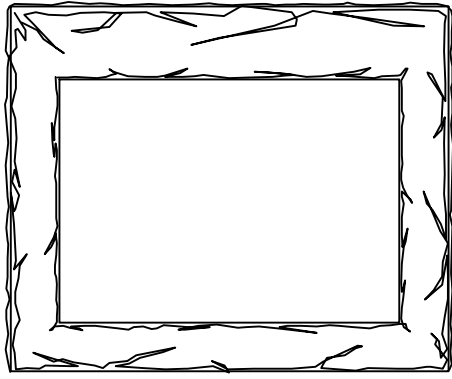

AG-H-145

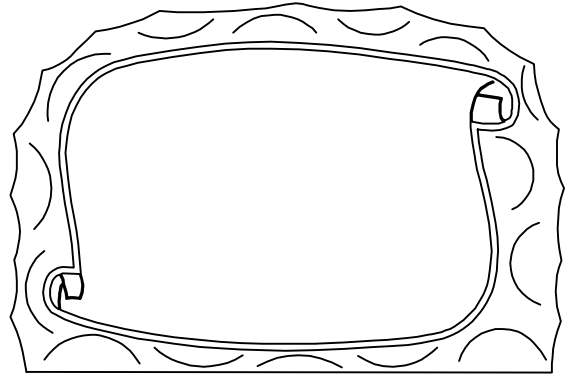

AG-H-146

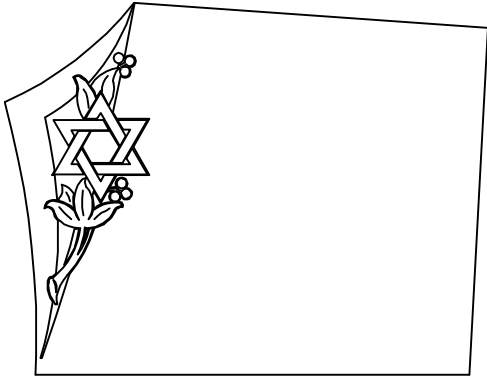

AG-H-147

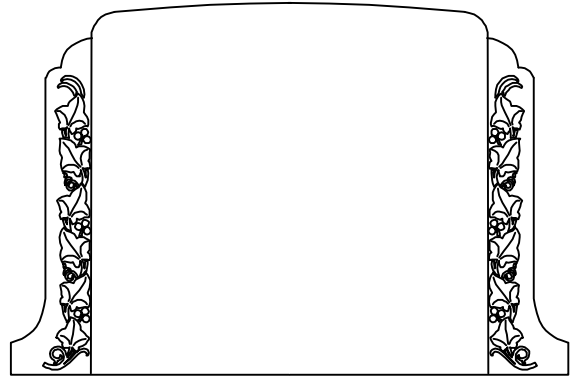

AG-H-148

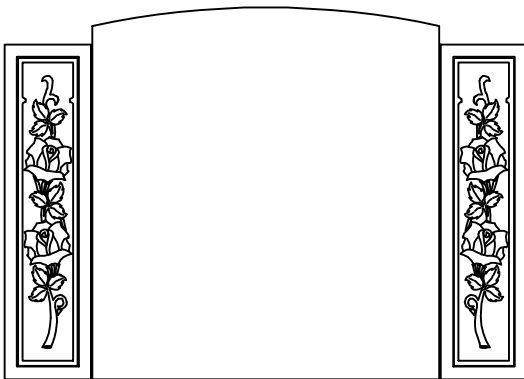

AG-H-149



AG-H-150

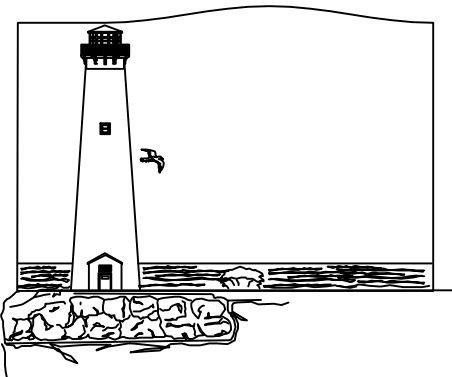

AG-H-151

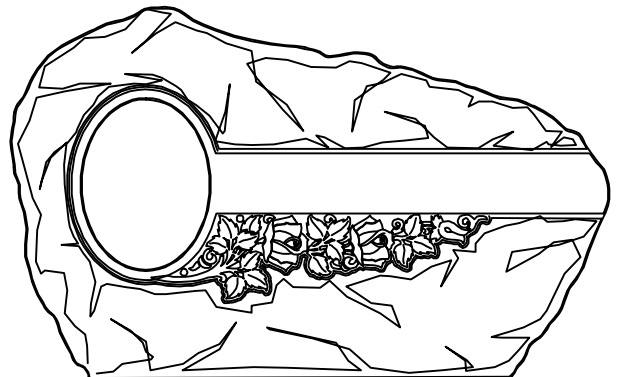

AG-H-152

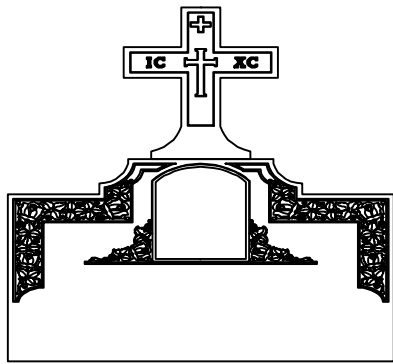

AG-H153

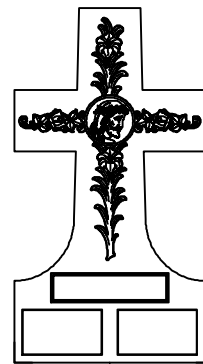

AG-H154

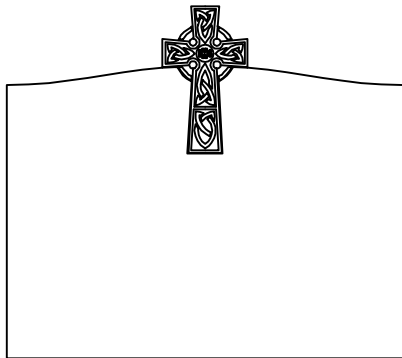

AG-H155

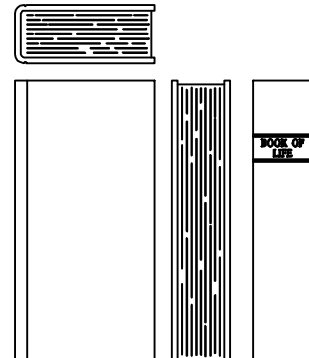

AG-H156

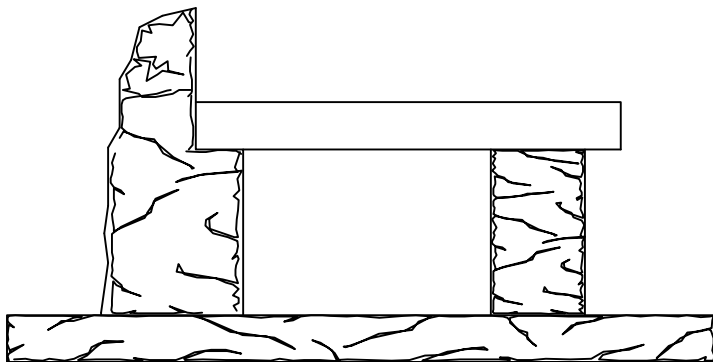

AG-H157

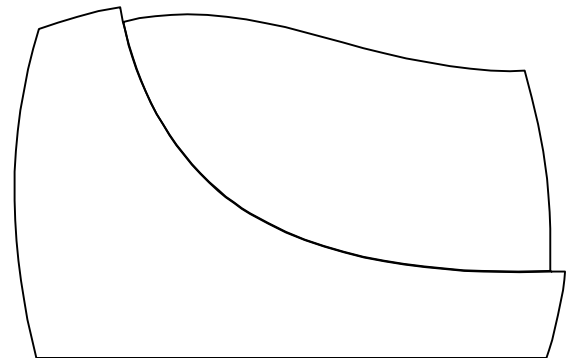

AG-H158

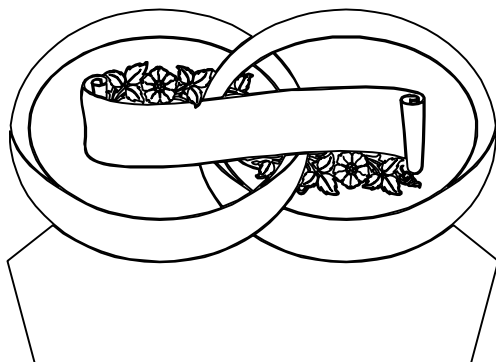

AG-H159

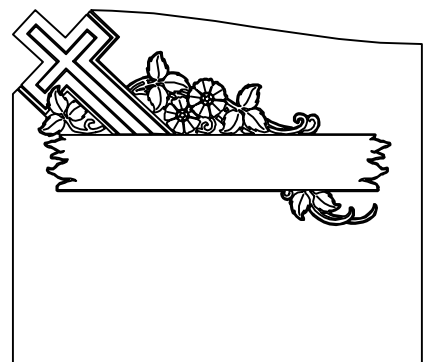

AG-H160



Vertical Dies

APPENDIX A

Name	Length	Height	Name	Length	Height
AG-V-1	22"	30"	AG-V-41	22"	28"
AG-V-2	20"	30"	AG-V-42	20"	28"
AG-V-3	24"	30"	AG-V-43	22"	30"
AG-V-4	22"	36"	AG-V-44	22"	28"
AG-V-5	20"	28"	AG-V-45	22"	28"
AG-V-6	20"	28"	AG-V-46	24"	30"
AG-V-7	20"	24"	AG-V-47	20"	26"
AG-V-8	24"	26"	AG-V-48	24"	30"
AG-V-9	20"	26"	AG-V-49	20"	24"
AG-V-10	20"	26"	AG-V-50	20"	26"
AG-V-11	24"	28"	AG-V-51	20"	30"
AG-V-12	20"	28"	AG-V-52	22"	30"
AG-V-13	20"	28"	AG-V-53	24"	33"
AG-V-14	20"	24"	AG-V-54	22"	28"
AG-V-15	20"	28"	AG-V-55	24"	26"
AG-V-16	20"	28"	AG-V-56	20"	30"
AG-V-17	22"	30"	AG-V-57	22"	30"
AG-V-18	20"	28"	AG-V-58	22"	30"
AG-V-19	20"	28"	AG-V-59	22"	36"
AG-V-20	22"	28"	AG-V-60	22"	36"
AG-V-21	20"	26"	AG-V-61	24"	36"
AG-V-22	20"	28"	AG-V-62	20"	30"
AG-V-23	20"	28"	AG-V-63	22"	36"
AG-V-24	22"	30"	AG-V-64	20"	36"
AG-V-25	20"	26"	AG-V-65	20"	36"
AG-V-26	24"	28"	AG-V-66	24"	36"
AG-V-27	22"	28"	AG-V-67	20"	42"
AG-V-28	20"	30"	AG-V-68	22"	36"
AG-V-29	20"	30"	AG-V-69	18"	30"
AG-V-30	22"	30"	AG-V-70	22"	36"
AG-V-31	24"	28"	AG-V-71	20"	36"
AG-V-32	20"	28"	AG-V-72	20"	36"
AG-V-33	20"	26"	AG-V-73	22"	36"
AG-V-34	20"	30"	AG-V-74	22"	42"
AG-V-35	20"	24"	AG-V-75	20"	42"
AG-V-36	20"	28"	AG-V-76	20"	24"
AG-V-37	24"	28"	AG-V-77	20"	30"
AG-V-38	20"	30"	AG-V-78	20"	36"
AG-V-39	20"	26"	AG-V-79	20"	36"
AG-V-40	20"	28"	AG-V-80	20"	36"

APPENDIX B

Name	Length	Height	Name	Length	Height
AG-V-81	20"	36"	AG-V-121	20"	30"
AG-V-82	20"	36"	AG-V-122	20"	24"
AG-V-83	20"	24"	AG-V-123	20"	28"
AG-V-84	22"	36"	AG-V-124	22"	30"
AG-V-85	20"	36"	AG-V-125	22"	30"
AG-V-86	20"	36"	AG-V-126	24"	30"
AG-V-87	20"	36"	AG-V-127	20"	24"
AG-V-88	22"	36"	AG-V-128	22"	30"
AG-V-89	20"	36"	AG-V-129	22"	30"
AG-V-90	20"	36"	AG-V-130	20"	28"
AG-V-91	22"	48"	AG-V-131	20"	32"
AG-V-92	22"	48"	AG-V-132	22"	28"
AG-V-93	18"	30"	AG-V-133	20"	26"
AG-V-94	20"	30"	AG-V-134	22"	28"
AG-V-95	22"	42"	AG-V-135	20"	28"
AG-V-96	24"	36"	AG-V-136	20"	28"
AG-V-97	20"	32"	AG-V-137	24"	33"
AG-V-98	20"	30"	AG-V-138	22"	30"
AG-V-99	20"	30"	AG-V-139	20"	28"
AG-V-100	20"	30"	AG-V-140	20"	26"
AG-V-101	24"	30"	AG-V-141	20"	30"
AG-V-102	20"	28"	AG-V-142	24"	24"
AG-V-103	20"	28"	AG-V-143	20"	30"
AG-V-104	20"	32"	AG-V-144	20"	28"
AG-V-105	22"	28"	AG-V-145	22"	30"
AG-V-106	22"	28"	AG-V-146	22"	30"
AG-V-107	20"	28"	AG-V-147	24"	28"
AG-V-108	22"	28"	AG-V-148	24"	28"
AG-V-109	20"	28"	AG-V-149	22"	30"
AG-V-110	24"	33"	AG-V-150	24"	28"
AG-V-111	20"	24"	AG-V-151	20"	30"
AG-V-112	21"	28"	AG-V-152	26"	30"
AG-V-113	24"	30"	AG-V-153	24"	26"
AG-V-114	20"	26"	AG-V-154	24"	26"
AG-V-115	24"	28"	AG-V-155	20"	32"
AG-V-116	24"	28"	AG-V-156	22"	28"
AG-V-117	24"	24"	AG-V-157	24"	22"
AG-V-118	20"	26"	AG-V-158	30"	36"
AG-V-119	22"	18"	AG-V-159	24"	30"
AG-V-120	18"	20"	AG-V-160	24"	30"

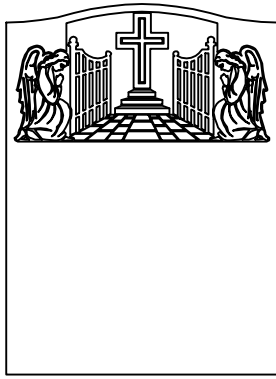

AG-V-01

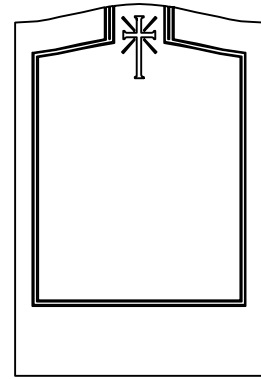

AG-V-02

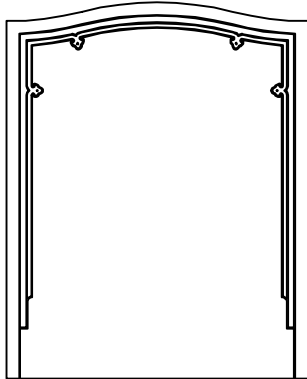

AG-V-03

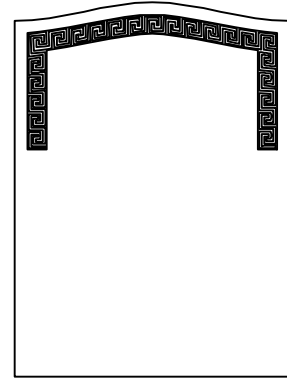

AG-V-04

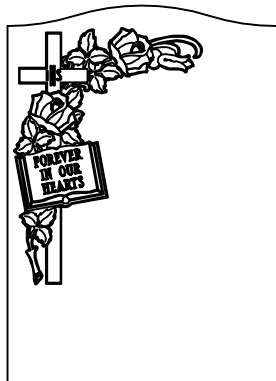

AG-V-05

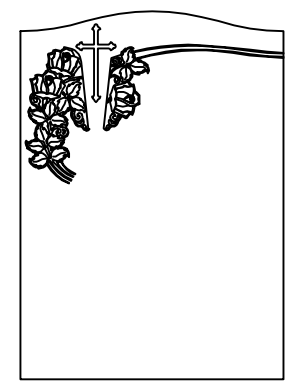

AG-V-06

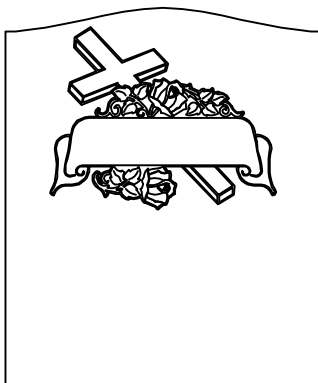

AG-V-07

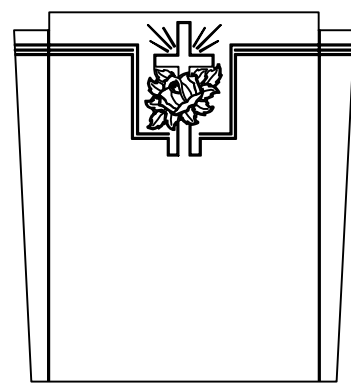

AG-V-08

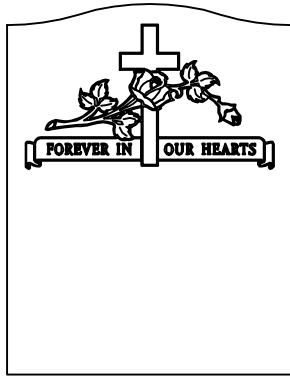

AG-V-09

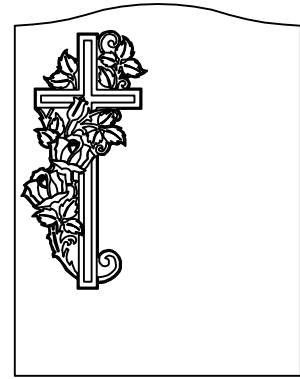

AG-V-10

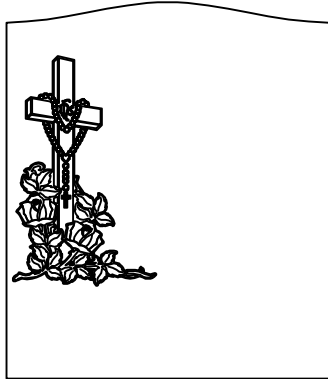

AG-V-11

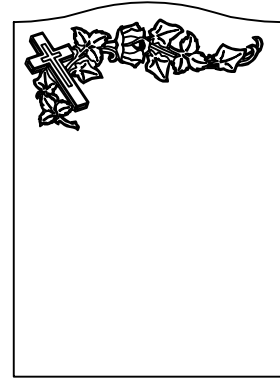

AG-V-12

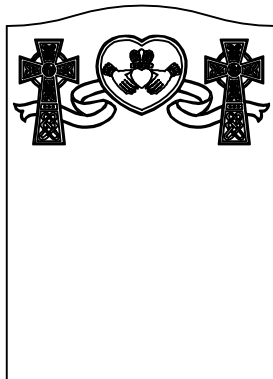

AG-V-13

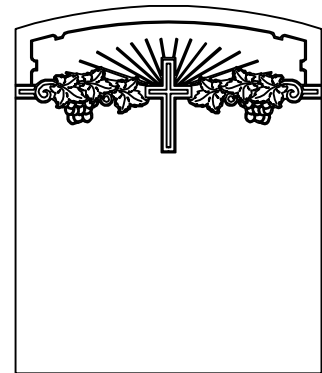

AG-V-14

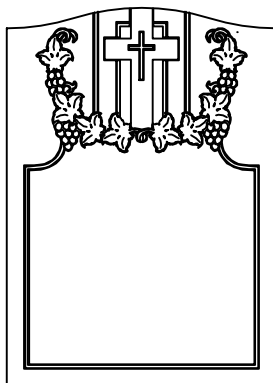

AG-V-15



AG-V-16

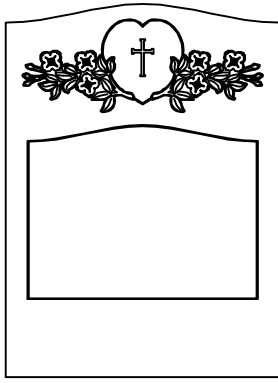

AG-V-17

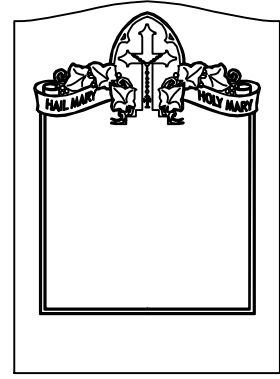

AG-V-18

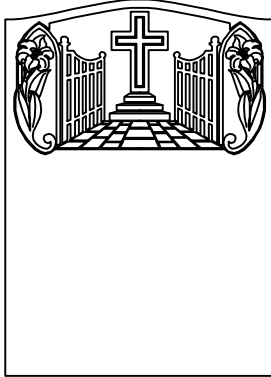

AG-V-19

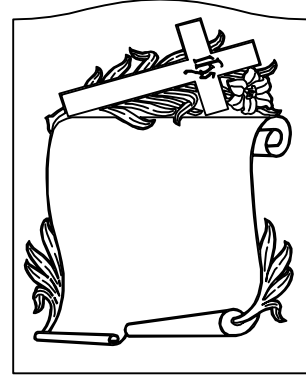

AG-V-20

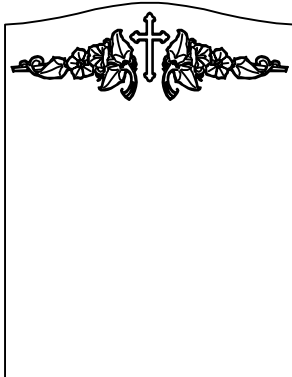

AG-V-21

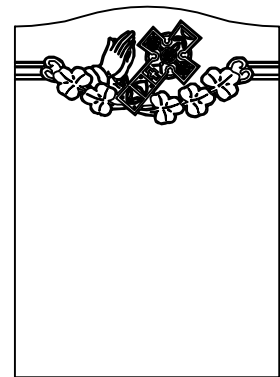

AG-V-22

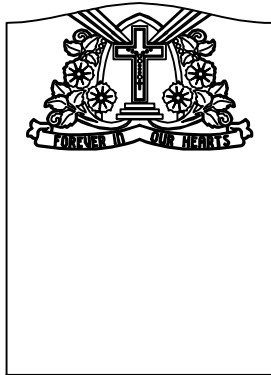

AG-V-23

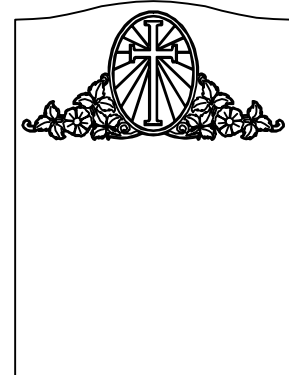

AG-V-24

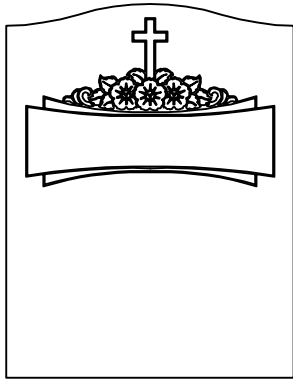

AG-V-25

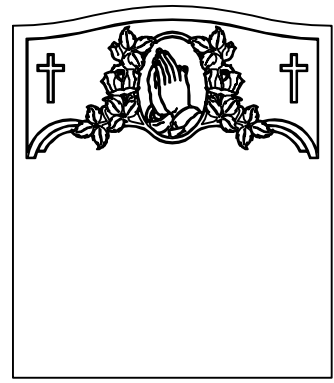

AG-V-26

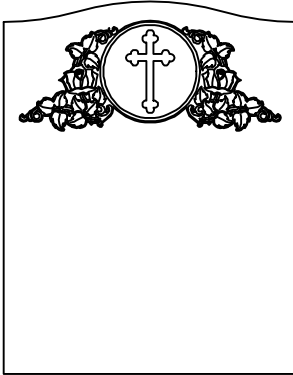

AG-V-27

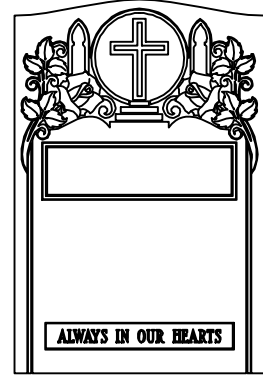

AG-V-28

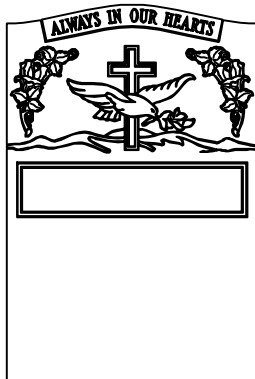

AG-V-29

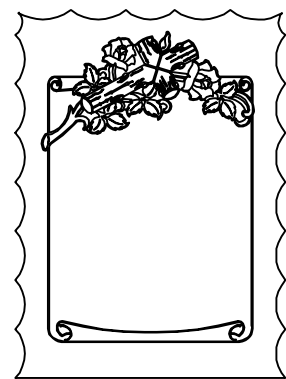

AG-V-30

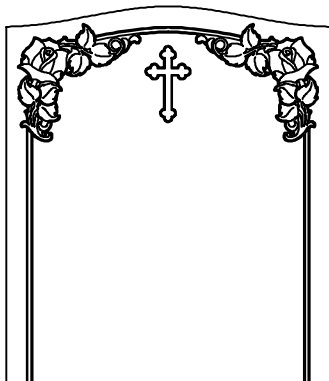

AG-V-31

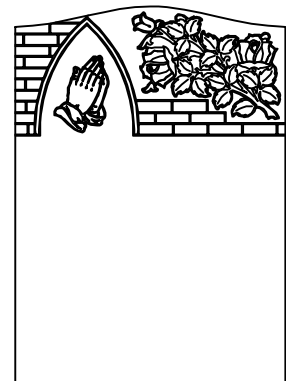

AG-V-32

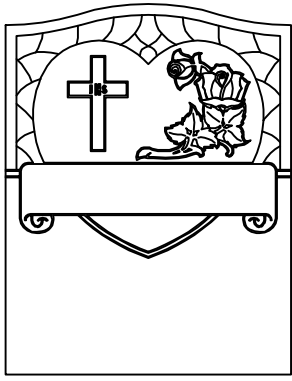

AG-V-33

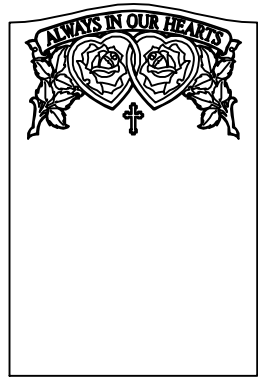

AG-V-34

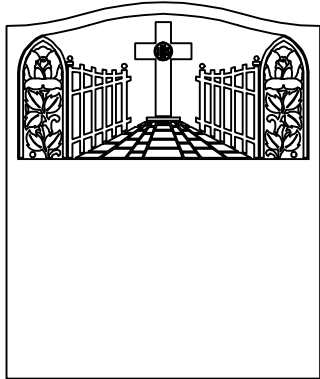

AG-V-35

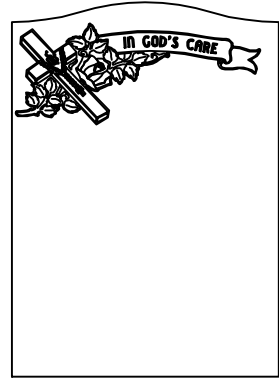

AG-V-36



AG-V-37

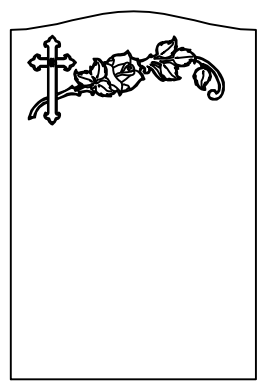

AG-V-38

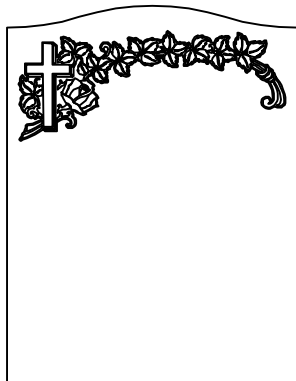

AG-V-39

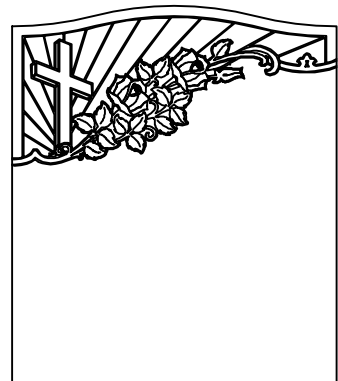

AG-V-40

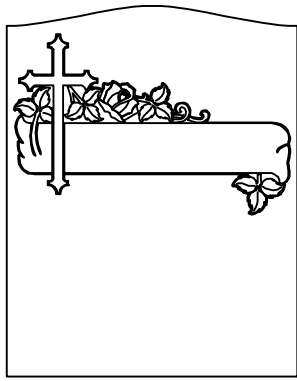

AG-V-41

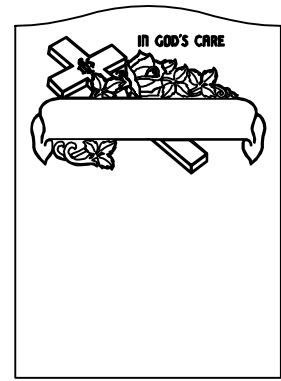

AG-V-42

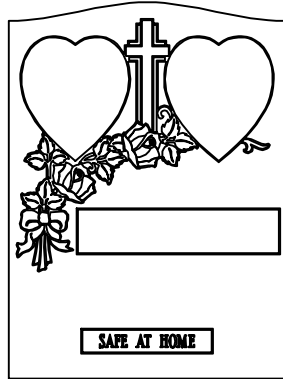

AG-V-43

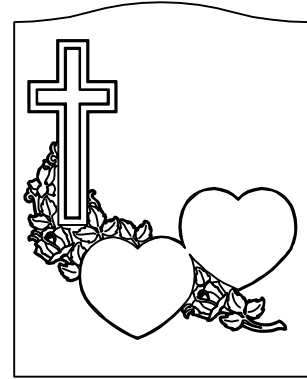

AG-V-44

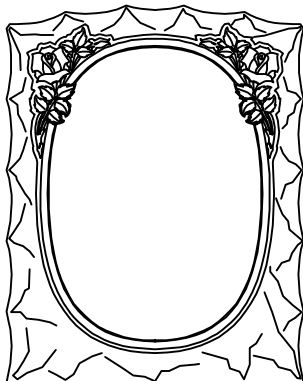

AG-V-45

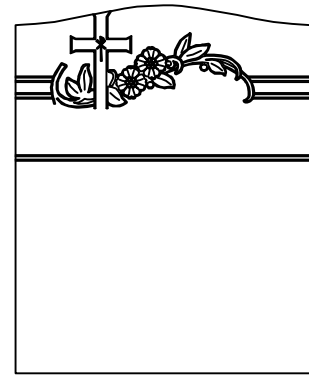

AG-V-46

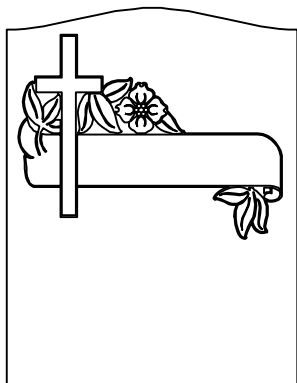

AG-V-47

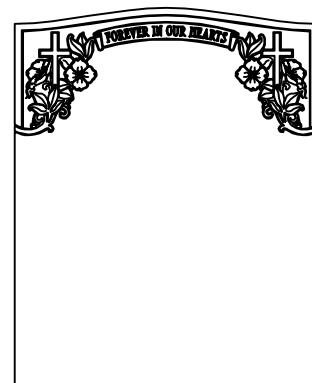

AG-V-48

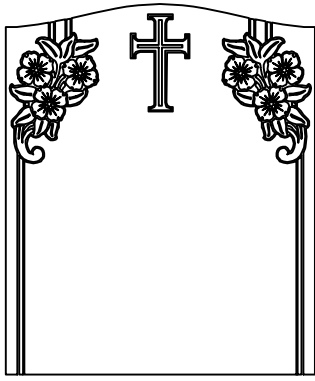

AG-V-49

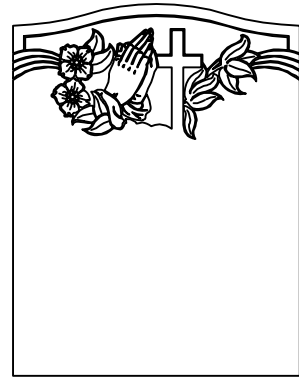

AG-V-50

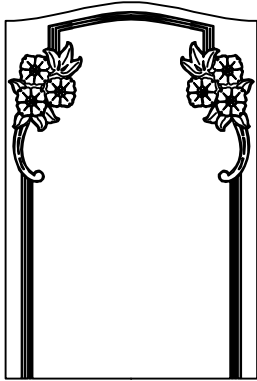

AG-V-51

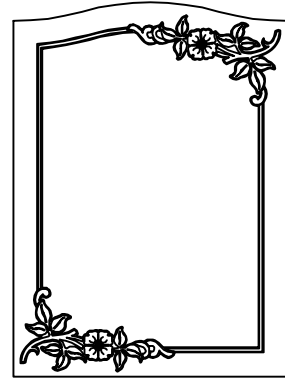

AG-V-52

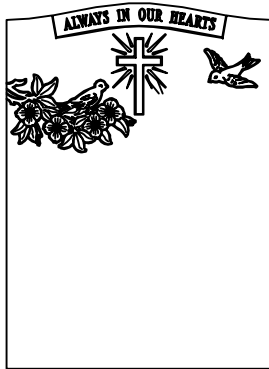

AG-V-53

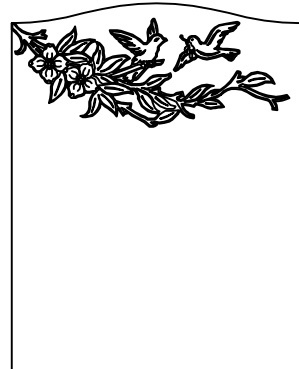

AG-V-54

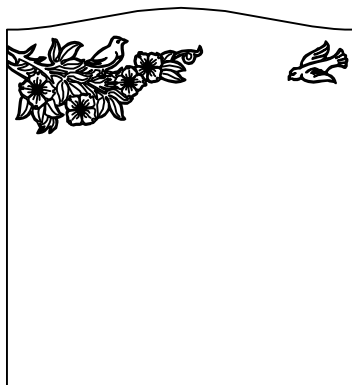

AG-V-55

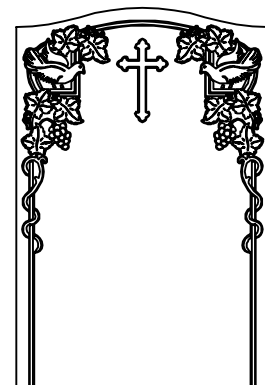

AG-V-56

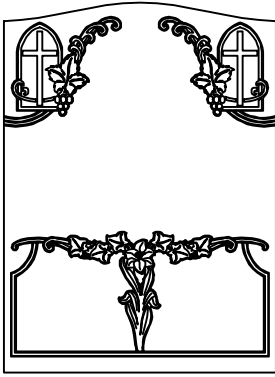

AG-V-57

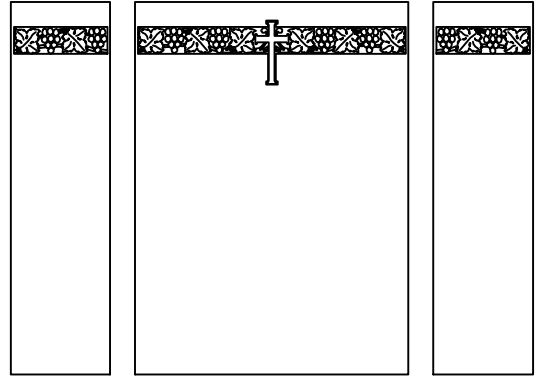

AG-V-58

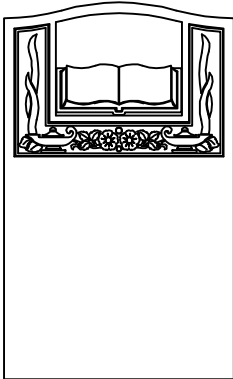

AG-V-59

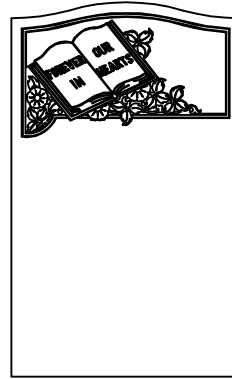

AG-V-60

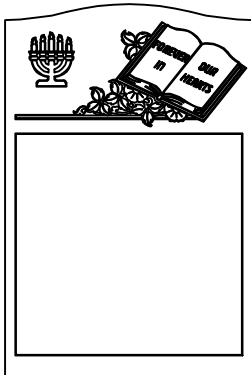

AG-V-61

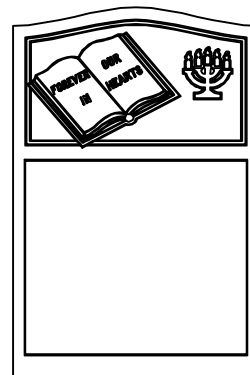

AG-V-62

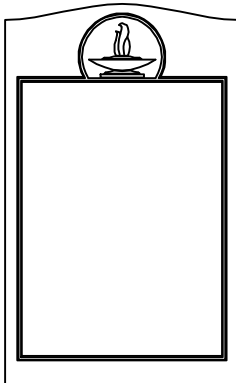

AG-V-63

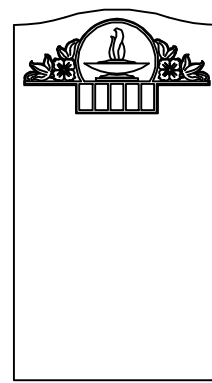

AG-V-64

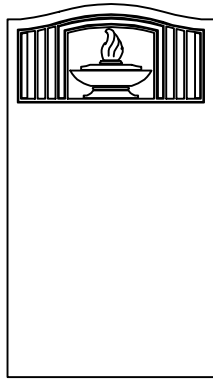

AG-V-65

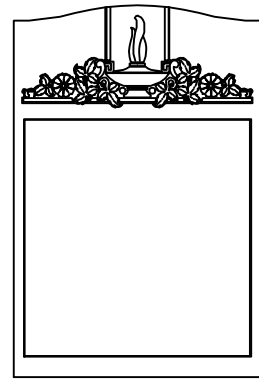

AG-V-66

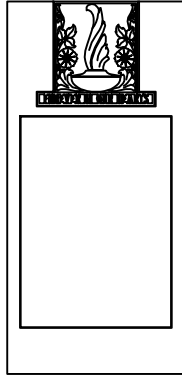

AG-V-67

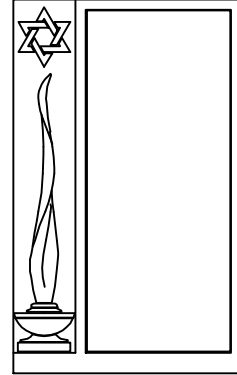

AG-V-68

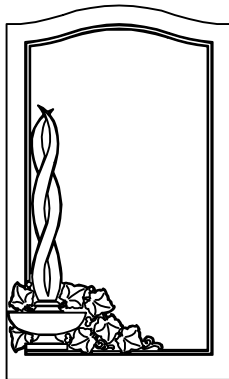

AG-V-69

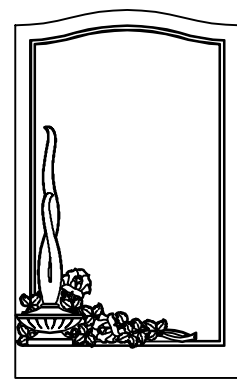

AG-V-70

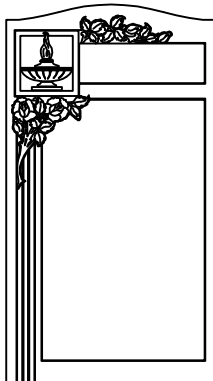

AG-V-71

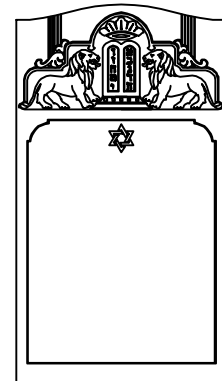

AG-V-72

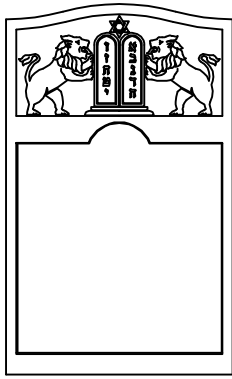

AG-V-73

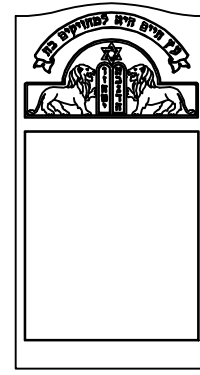

AG-V-74

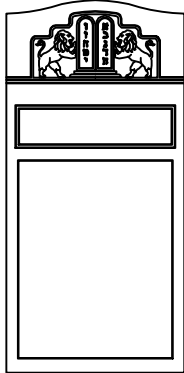

AG-V-75

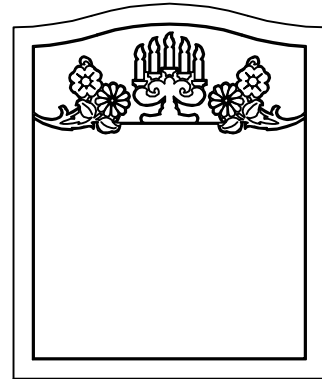

AG-V-76

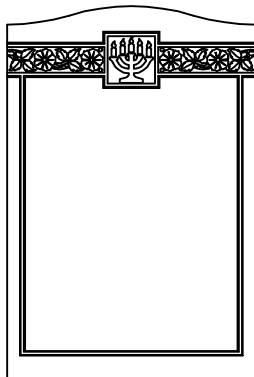

AG-V-77

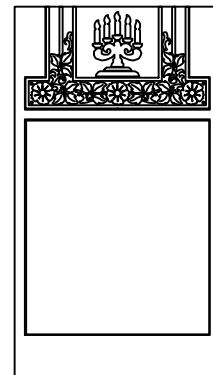

AG-V-78

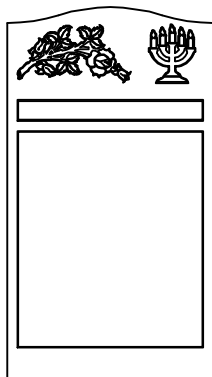

AG-V-79

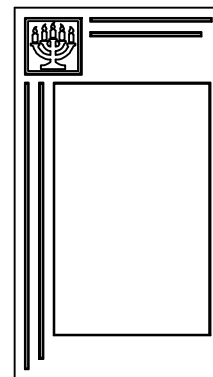

AG-V-80

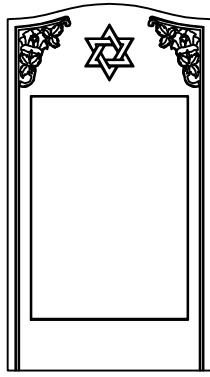

AG-V-81

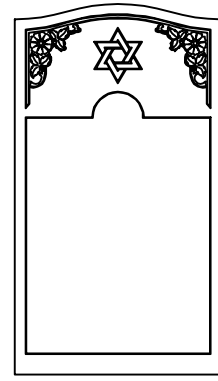

AG-V-82

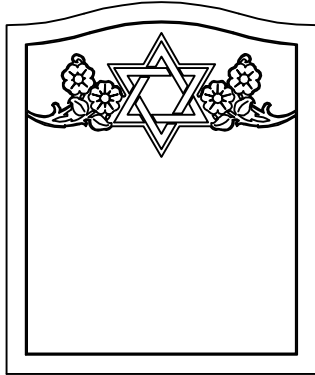

AG-V-83

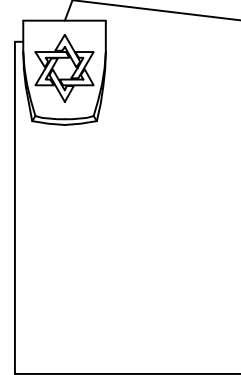

AG-V-84

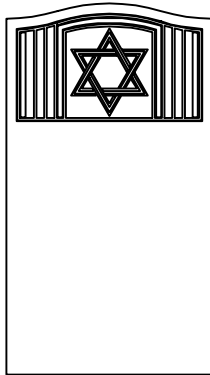

AG-V-85

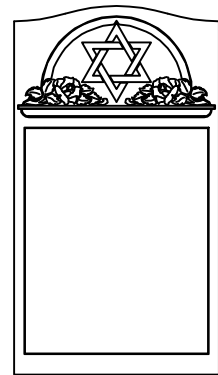

AG-V-86

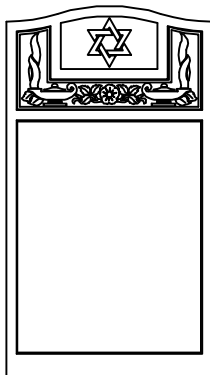

AG-V-87

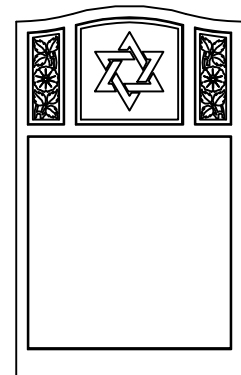

AG-V-88

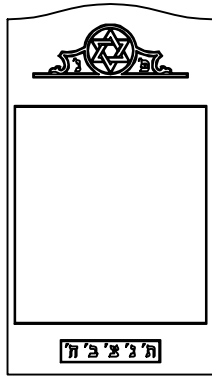

AG-V-89

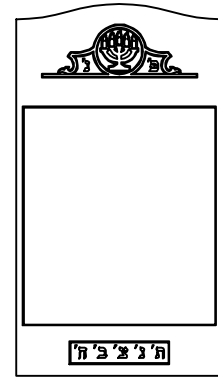

AG-V-90

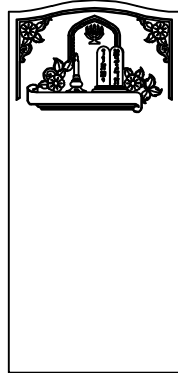

AG-V-91

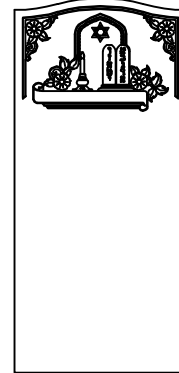

AG-V-92

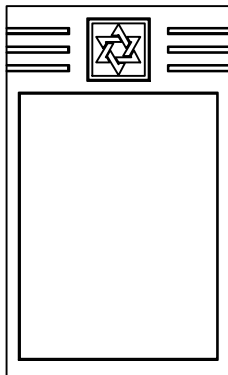

AG-V-93

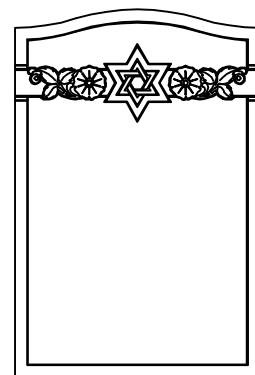

AG-V-94

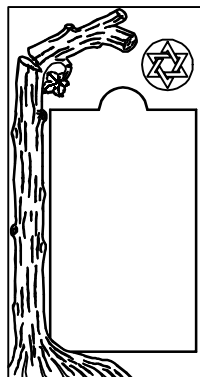

AG-V-95

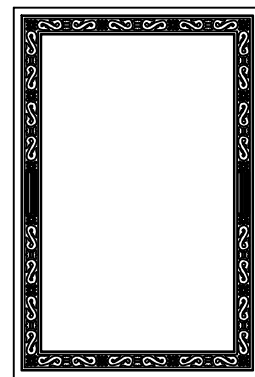

AG-V-96

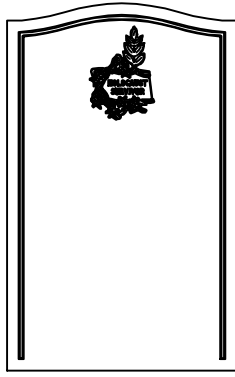

AG-V-97

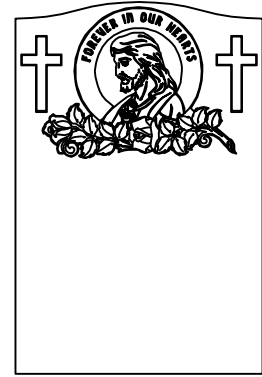

AG-V-98

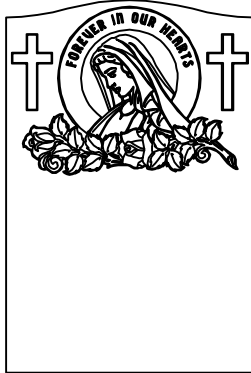

AG-V-99



AG-V-100

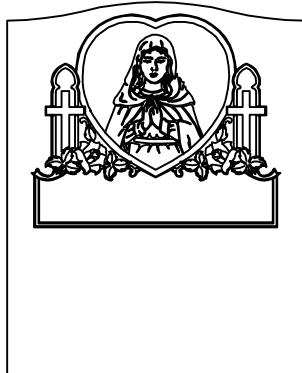

AG-V-101

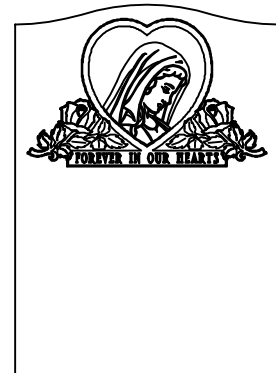

AG-V-102



AG-V-103



AG-V-104

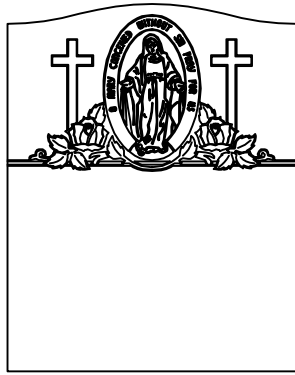

AG-V-105

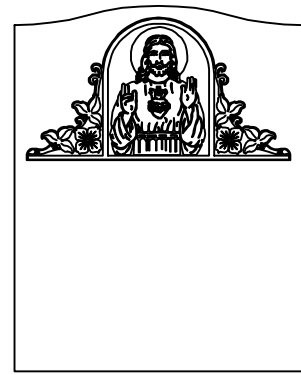

AG-V-106

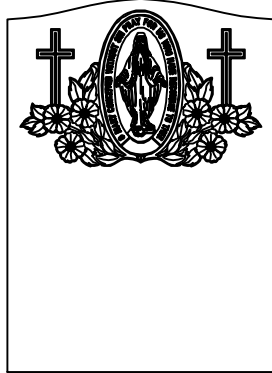

AG-V-107

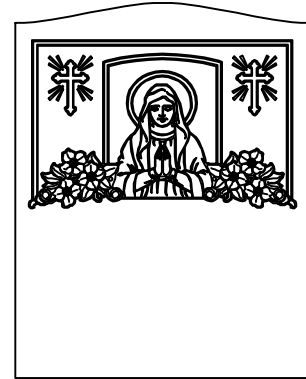

AG-V-108

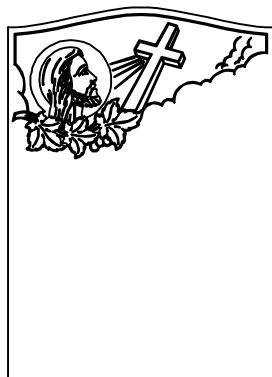

AG-V-109



AG-V-110



AG-V-111

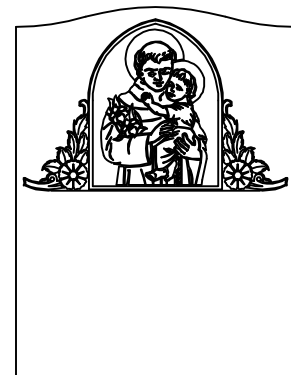

AG-V-112

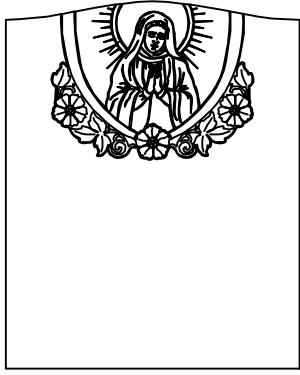

AG-V-113



AG-V-114

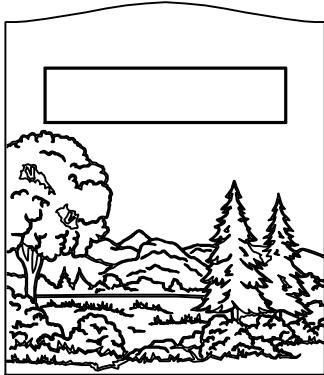

AG-V-115

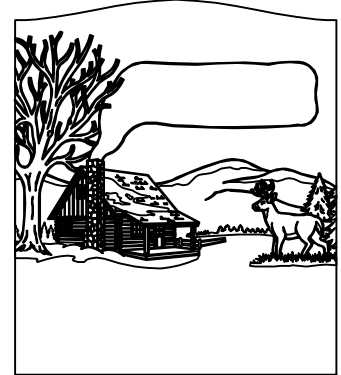

AG-V-116

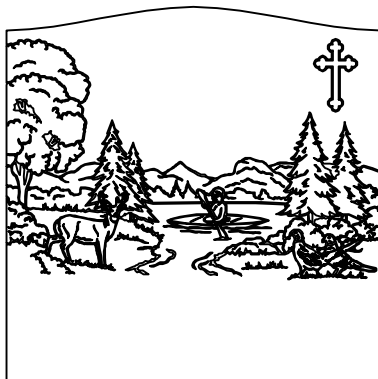

AG-V-117

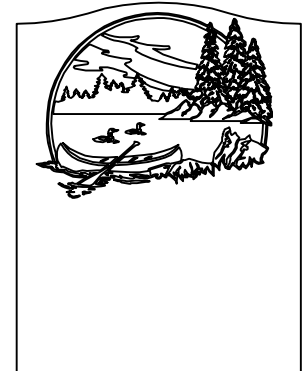

AG-V-118

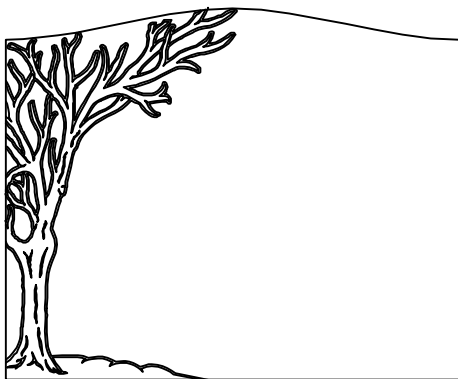

AG-V-119

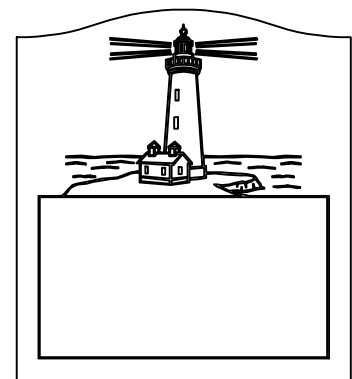

AG-V-120

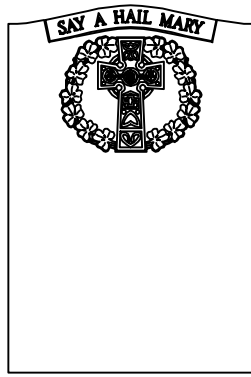

AG-V-121

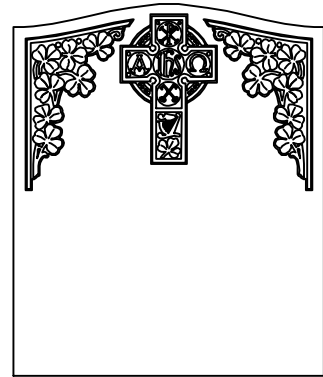

AG-V-122

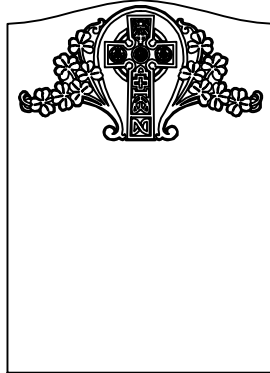

AG-V-123

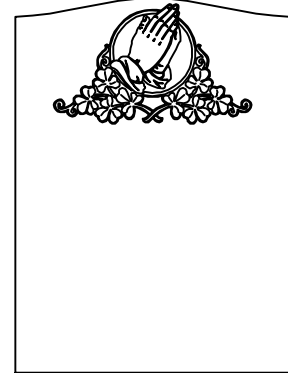

AG-V-124

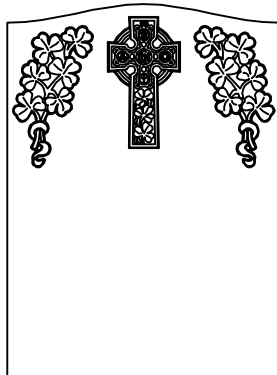

AG-V-125

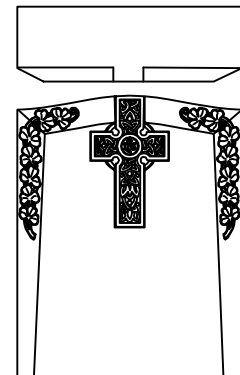

AG-V-126

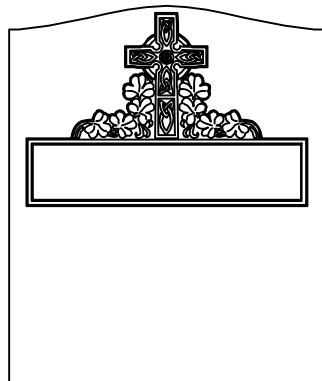

AG-V-127

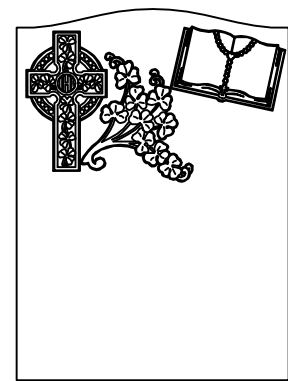

AG-V-128

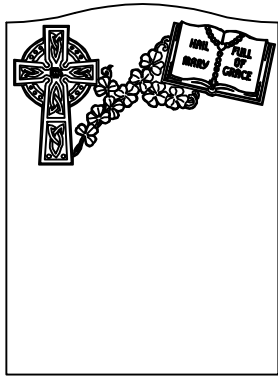

AG-V-129

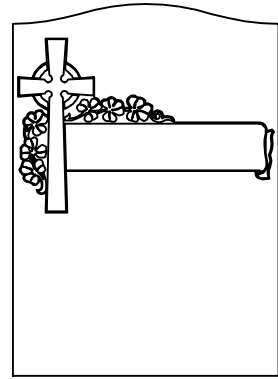

AG-V-130

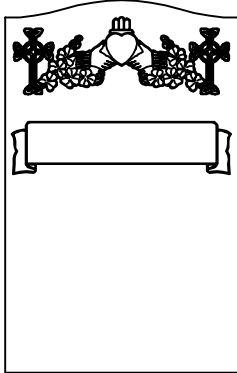

AG-V-131

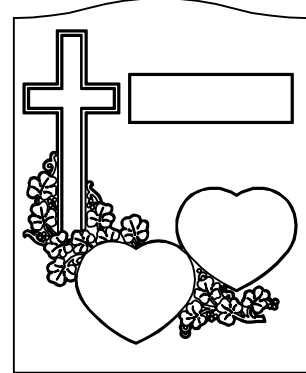

AG-V-132

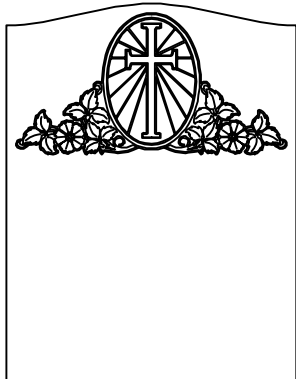

AG-V-133

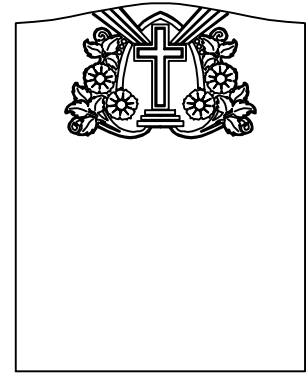

AG-V-134

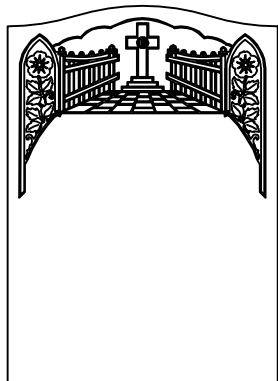

AG-V-135

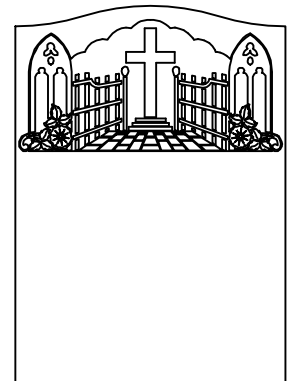

AG-V-136

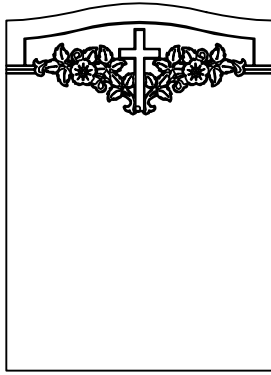

AG-V-137

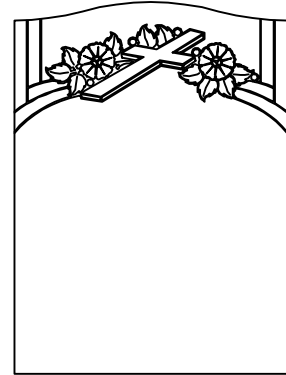

AG-V-138

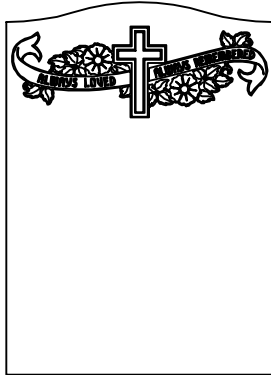

AG-V-139

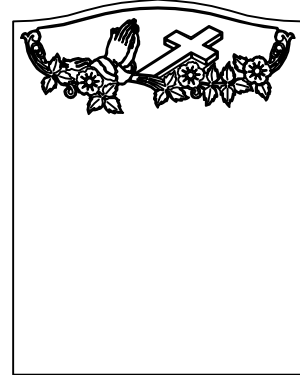

AG-V-140



AG-V-141

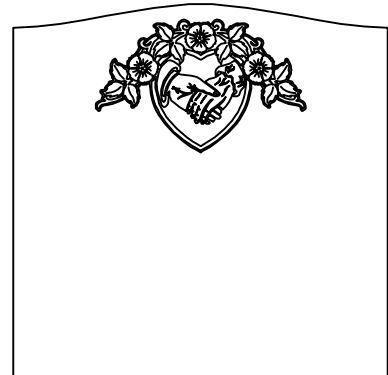

AG-V-142

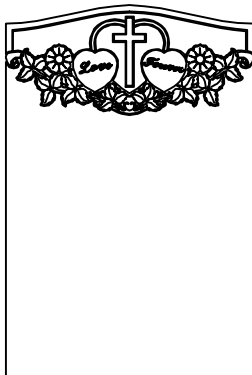

AG-V-143

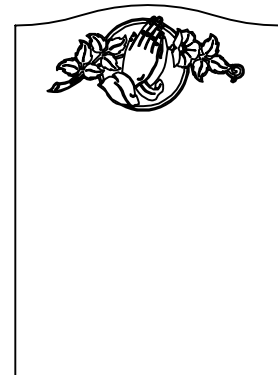

AG-V-144

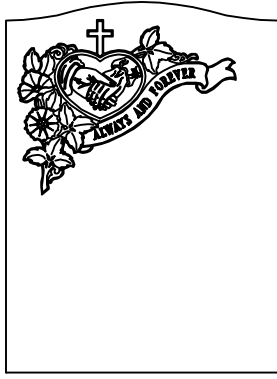

AG-V-145

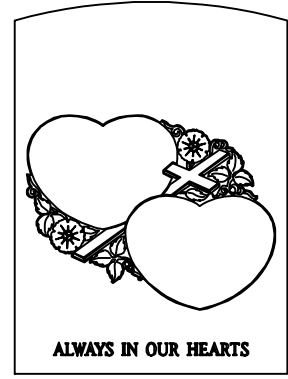

AG-V-146

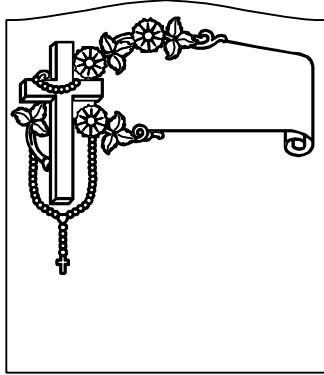

AG-V-147

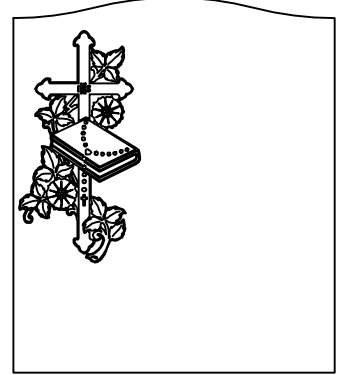

AG-V-148

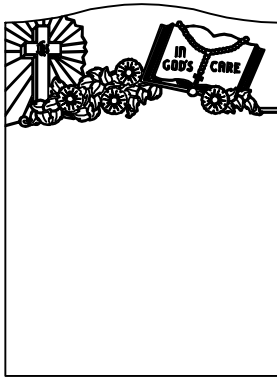

AG-V-149

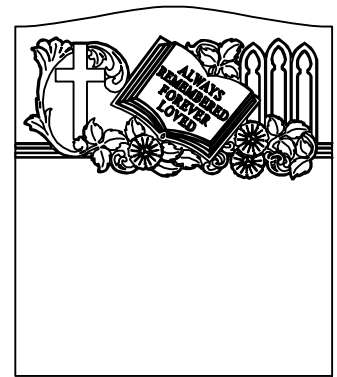

AG-V-150

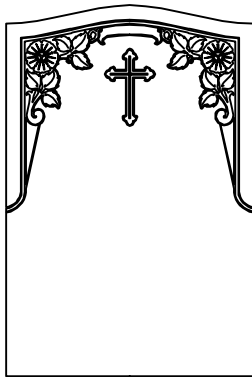

AG-V-151

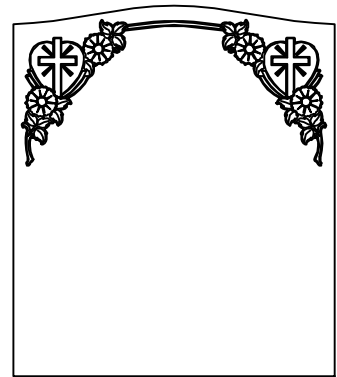

AG-V-152

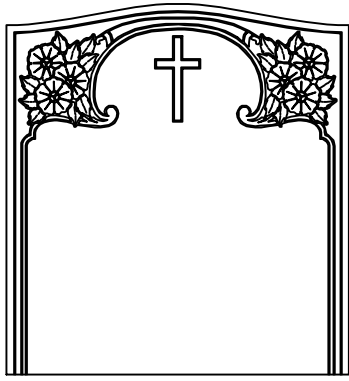

AG-V-153

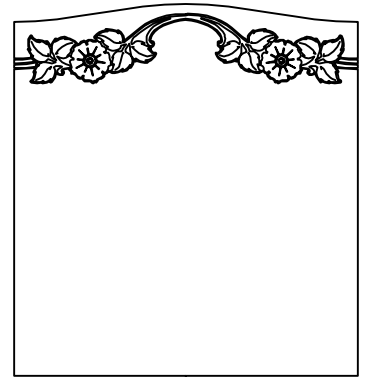

AG-V-154

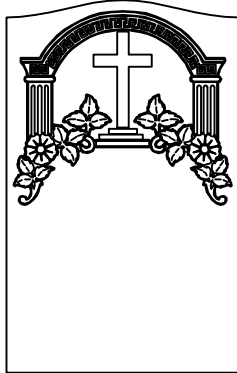

AG-V-155



AG-V-156

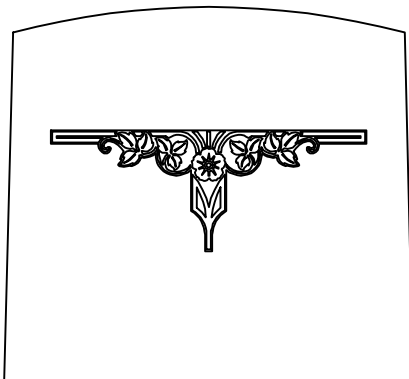

AG-V-157

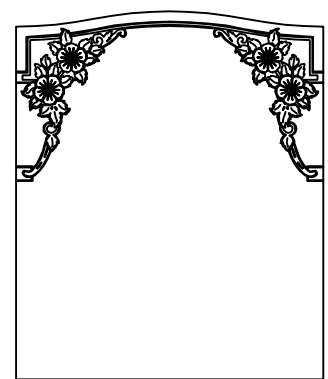

AG-V-158

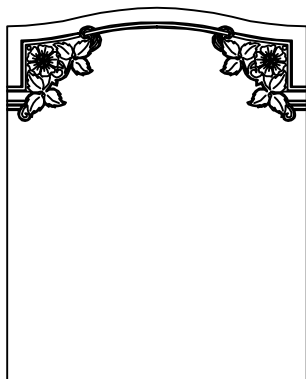

AG-V-159

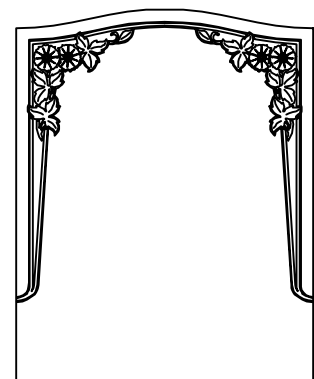

AG-V-160



Slants

APPENDIX A

Name	Length	Height	Name	Length	Height
AG-S-1	24"	16 1/8"	AG-S-41	30"	17"
AG-S-2	24"	15 1/2"	AG-S-42	24"	17"
AG-S-3	20"	15 1/2"	AG-S-43	24"	17"
AG-S-4	24"	17"	AG-S-44	24"	16 3/8"
AG-S-5	24"	17"	AG-S-45	24"	17"
AG-S-6	24"	16 1/4"	AG-S-46	24"	17"
AG-S-7	24"	17"	AG-S-47	24"	14 3/8"
AG-S-8	24"	14 3/4"	AG-S-48	24"	15 1/4"
AG-S-9	24"	17"	AG-S-49	24"	17"
AG-S-10	24"	18"	AG-S-50	24"	17"
AG-S-11	24"	17"	AG-S-51	24"	17"
AG-S-12	24"	17"	AG-S-52	26"	17"
AG-S-13	24"	15 1/2"	AG-S-53	30"	16"
AG-S-14	25"	17"	AG-S-54	30"	15 1/2"
AG-S-15	26"	15 1/2"	AG-S-55	36"	17"
AG-S-16	30"	15 1/2"	AG-S-56	42"	15 1/2"
AG-S-17	30"	14 5/8"	AG-S-57	36"	17"
AG-S-18	30"	15 1/2"	AG-S-58	36"	15 1/2"
AG-S-19	30"	16 1/4"	AG-S-59	36"	19 3/4"
AG-S-20	30"	16"	AG-S-60	42"	17"
AG-S-21	36"	17"	AG-S-61	36"	15 1/4"
AG-S-22	36"	15 1/2"	AG-S-62	36"	15 1/2"
AG-S-23	36"	17"	AG-S-63	42"	17"
AG-S-24	36"	16 3/4"	AG-S-64	48"	16"
AG-S-25	36"	15 1/2"	AG-S-65	22"	17"
AG-S-26	36"	17"	AG-S-66	22"	17 7/8"
AG-S-27	36"	17"	AG-S-67	24"	15 1/2"
AG-S-28	36"	15 5/8"	AG-S-68	24"	17"
AG-S-29	36"	16 1/2"	AG-S-69	24"	15 1/2"
AG-S-30	36"	16 3/4"	AG-S-70	30"	15 1/4"
AG-S-31	36"	16 3/4"	AG-S-71	30"	15 1/2"
AG-S-32	36"	16 3/4"	AG-S-72	36"	15 1/2"
AG-S-33	36"	16 3/4"	AG-S-73	36"	15 1/4"
AG-S-34	36"	15 1/2"	AG-S-74	36"	15 1/2"
AG-S-35	42"	17"	AG-S-75	36"	15 1/2"
AG-S-36	36"	16"	AG-S-76	36"	17"
AG-S-37	36"	17"	AG-S-77	36"	15 1/4"
AG-S-38	36"	17"	AG-S-78	36"	17"
AG-S-39	36"	15 1/2"	AG-S-79	24"	15 1/2"
AG-S-40	36"	16 3/4"	AG-S-80	24"	15 1/2"

APPENDIX B

Name	Length	Height	Name	Length	Height
AG-S-81	24"	15 1/2"	AG-S-121	24"	16 3/8"
AG-S-82	24"	15 1/2"	AG-S-122	24"	18"
AG-S-83	24"	17"	AG-S-123	24"	15 1/2"
AG-S-84	24"	17"	AG-S-124	24"	18"
AG-S-85	24"	17"	AG-S-125	30"	15 1/2"
AG-S-86	30"	16"	AG-S-126	38"	17"
AG-S-87	30"	15 1/2"	AG-S-127	36"	15 1/2"
AG-S-88	24"	17"	AG-S-128	42"	17"
AG-S-89	24"	17"	AG-S-129	20"	15 1/2"
AG-S-90	28"	15 1/2"	AG-S-130	24"	15 1/2"
AG-S-91	26"	15"	AG-S-131	24"	15 1/2"
AG-S-92	30"	15 1/2"	AG-S-132	24"	17"
AG-S-93	24"	17"	AG-S-133	24"	15 1/2"
AG-S-94	24"	17"	AG-S-134	24"	15 1/4"
AG-S-95	24"	14 3/8"	AG-S-135	24"	17"
AG-S-96	24"	17"	AG-S-136	24"	15 1/2"
AG-S-97	24"	15 1/2"	AG-S-137	28"	15 1/2"
AG-S-98	24"	17"	AG-S-138	30"	18"
AG-S-99	30"	15 1/2"	AG-S-139	30"	15 1/4"
AG-S-100	30"	17"	AG-S-140	36"	15 1/2"
AG-S-101	36"	17"	AG-S-141	36"	15 1/2"
AG-S-102	36"	15 1/2"	AG-S-142	36"	17"
AG-S-103	36"	17"	AG-S-143	36"	15"
AG-S-104	36"	17"	AG-S-144	24"	15 1/2"
AG-S-105	20"	13 3/4"	AG-S-145	24"	17"
AG-S-106	20"	14 3/8"	AG-S-146	24"	18"
AG-S-107	24"	17"	AG-S-147	24"	15 1/2"
AG-S-108	24"	17"	AG-S-148	24"	16 1/2"
AG-S-109	24"	15 1/2"	AG-S-149	36"	15 1/2"
AG-S-110	36"	15 1/2"	AG-S-150	36"	18"
AG-S-111	24"	17"	AG-S-151	20"	15"
AG-S-112	24"	17"	AG-S-152	24"	17"
AG-S-113	36"	14 3/8"	AG-S-153	30"	17"
AG-S-114	36"	17"	AG-S-154	36"	17"
AG-S-115	42"	19 3/4"	AG-S-155	24"	17"
AG-S-116	20"	17"	AG-S-156	36"	17"
AG-S-117	24"	17"	AG-S-157	38"	15 1/2"
AG-S-118	24"	17"	AG-S-158	42"	14 3/8"
AG-S-119	24"	17"	AG-S-159	18"	15 1/2"
AG-S-120	24"	17"	AG-S-160	24"	14 3/4"

APPENDIX C

Name	Length	Height	Name	Length	Height
AG-S-161	24"	17"			
AG-S-162	24"	17"			
AG-S-163	24"	17"			
AG-S-164	24"	15 1/2"			
AG-S-165	24"	17 1/4"			
AG-S-166	24"	14 7/8"			
AG-S-167	24"	14 1/2"			
AG-S-168	24"	18"			
AG-S-169	24"	14 3/4"			
AG-S-170	24"	17"			
AG-S-171	24"	17"			
AG-S-172	24"	15 1/2"			
AG-S-173	24"	15 1/2"			
AG-S-174	24"	15 1/2"			
AG-S-175	24"	18"			
AG-S-176	28"	15 1/2"			
AG-S-177	28"	15 1/2"			
AG-S-178	24"	17"			
AG-S-179	30"	15 1/2"			
AG-S-180	30"	18"			
AG-S-181	30"	15 1/2"			
AG-S-182	30"	15 1/2"			
AG-S-183	30"	17"			
AG-S-184	30"	15 1/2"			
AG-S-185	30"	15 1/2"			
AG-S-186	36"	17"			
AG-S-187	36"	19"			
AG-S-188	36"	15 1/2"			
AG-S-189	36 1/4"	18 3/8"			
AG-S-190	36"	15 1/2"			
AG-S-191	36"	17"			
AG-S-192	36"	17"			
AG-S-193	36"	17"			
AG-S-194	36"	15 1/2"			
AG-S-195	36"	17"			
AG-S-196	36"	15 1/2"			
AG-S-197	36"	17"			
AG-S-198	36"	15 1/2"			
AG-S-199	36"	17"			
AG-S-200	36"	15 1/2"			
AG-S-201	42"	17"			
AG-S-202	42"	17"			
AG-S-203	54"	17"			

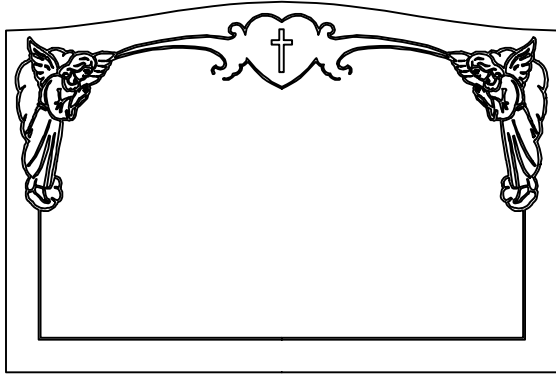

AG-S-01



AG-S-02

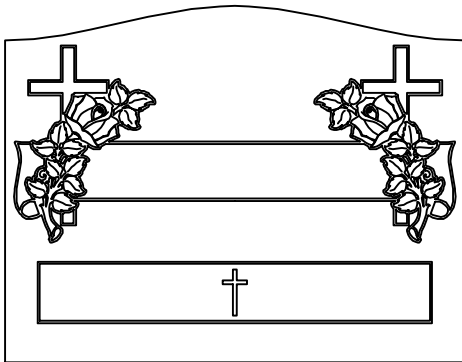

AG-S-03

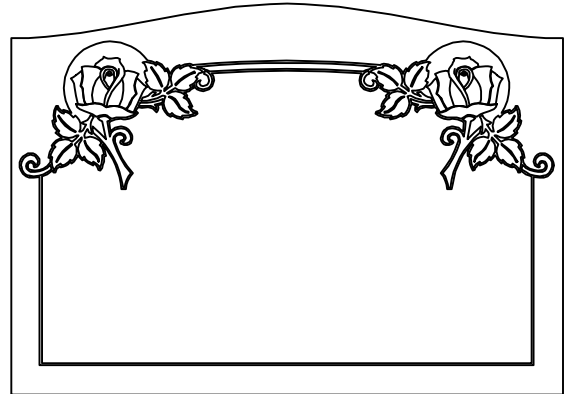

AG-S-04

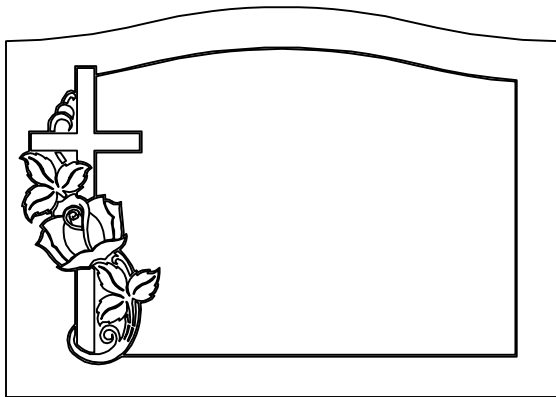

AG-S-05

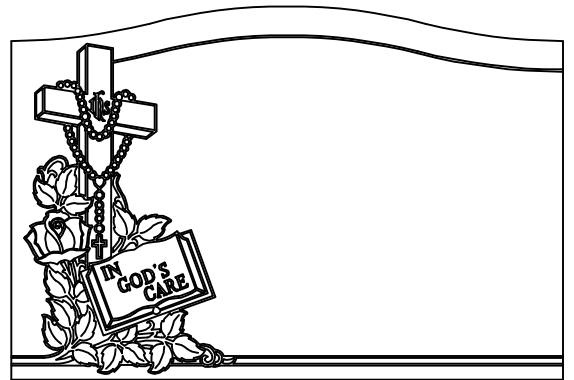

AG-S-06

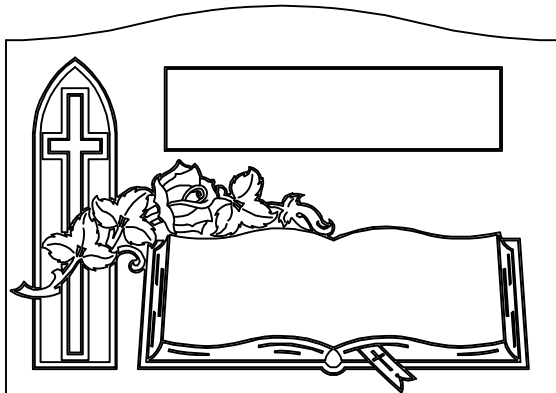

AG-S-07

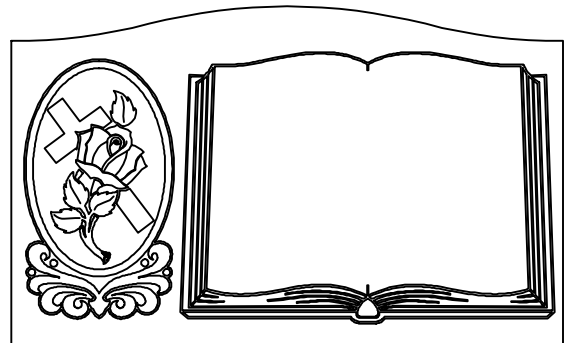

AG-S-08

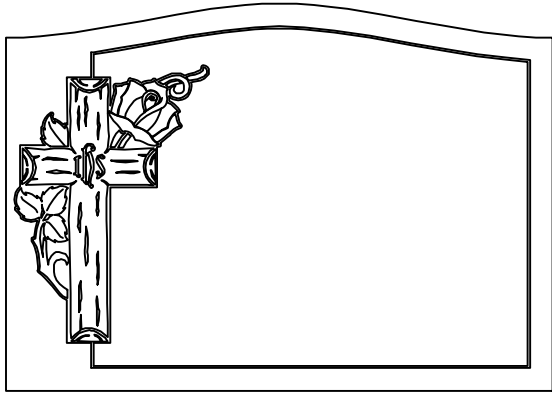

AG-S-09

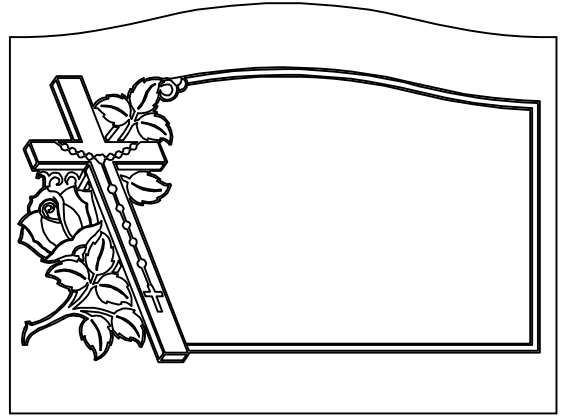

AG-S-10

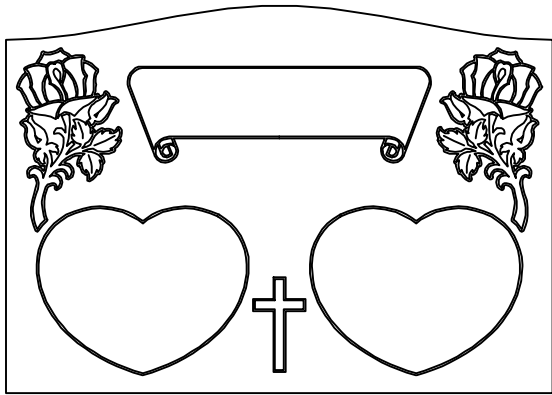

AG-S-11

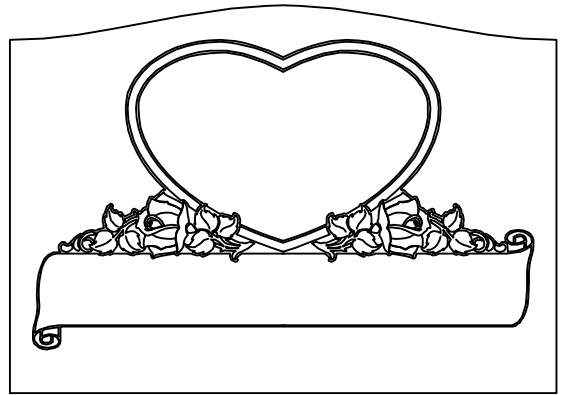

AG-S-12

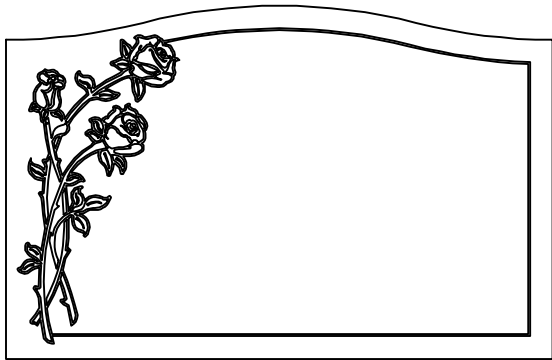

AG-S-13

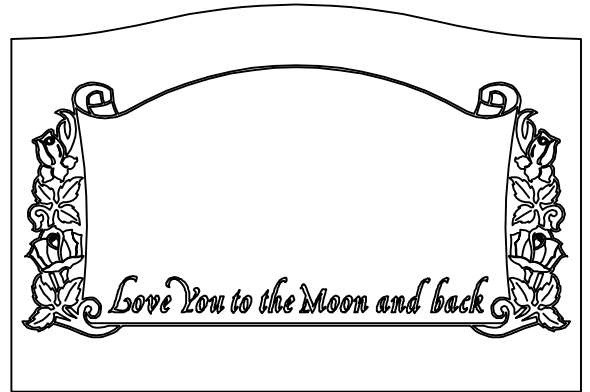

AG-S-14

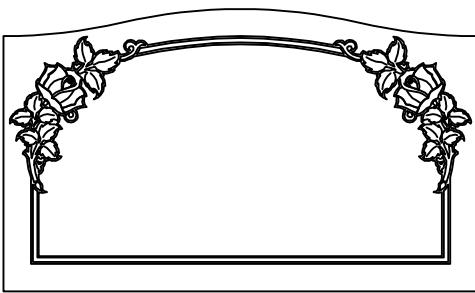

AG-S-15

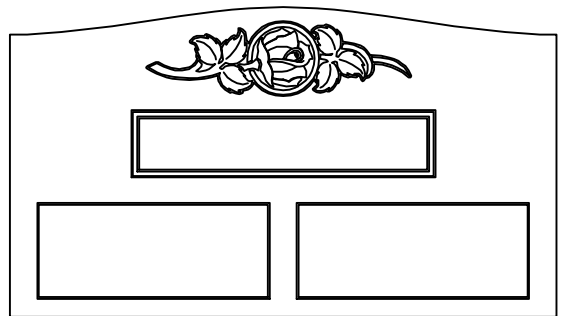

AG-S-16

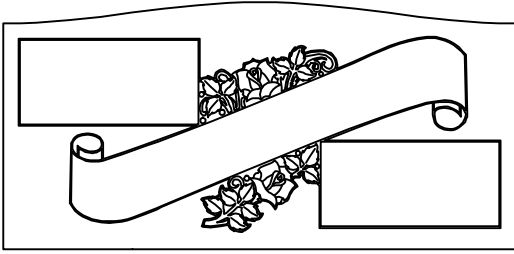

AG-S-17

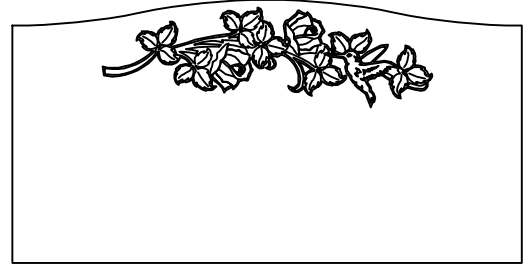

AG-S-18

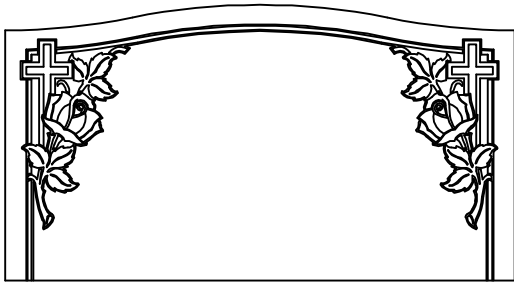

AG-S-19

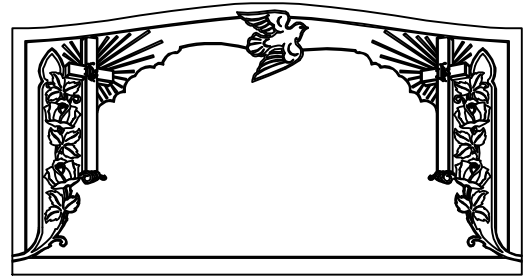

AG-S-20

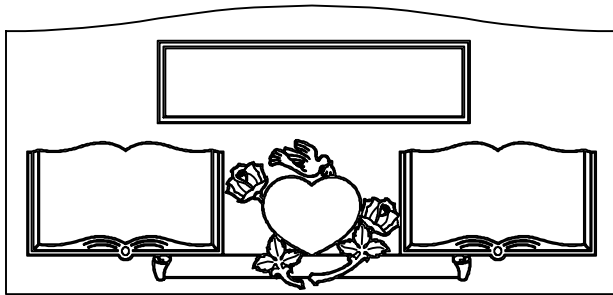

AG-S-21

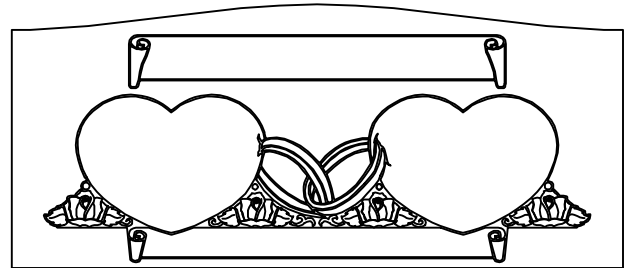

AG-S-22

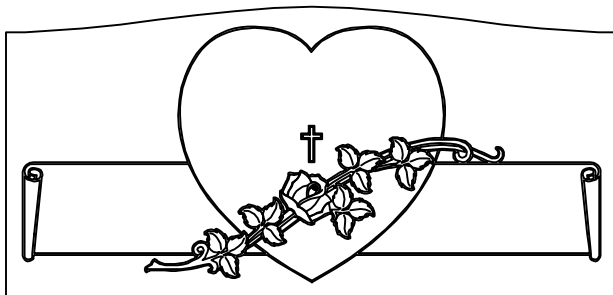

AG-S-23

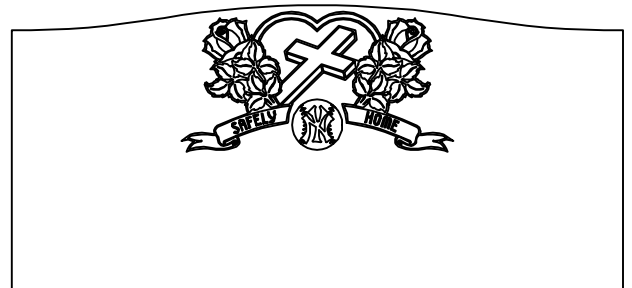

AG-S-24

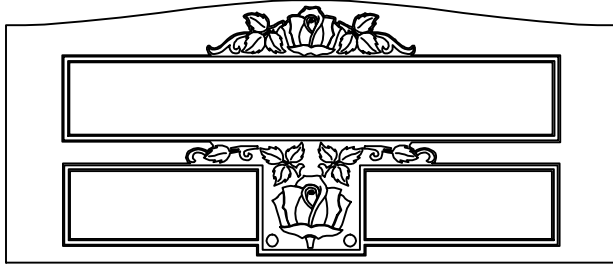

AG-S-25

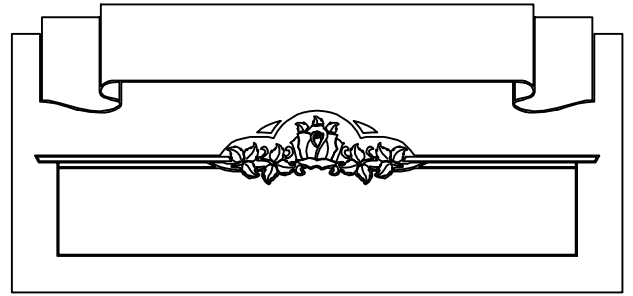

AG-S-26

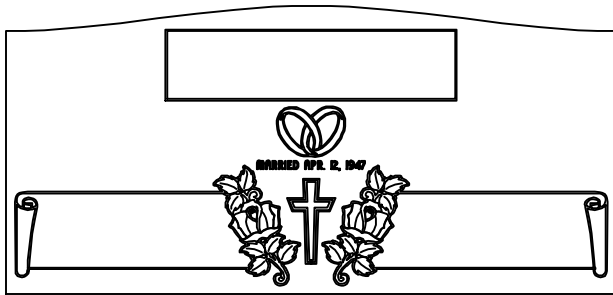

AG-S-27

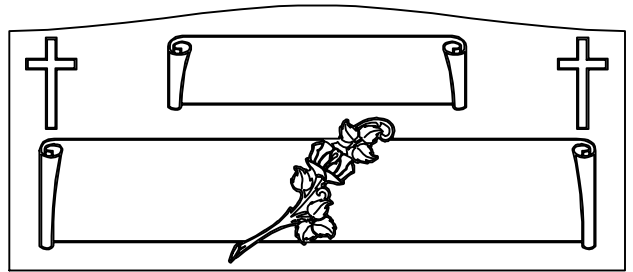

AG-S-28

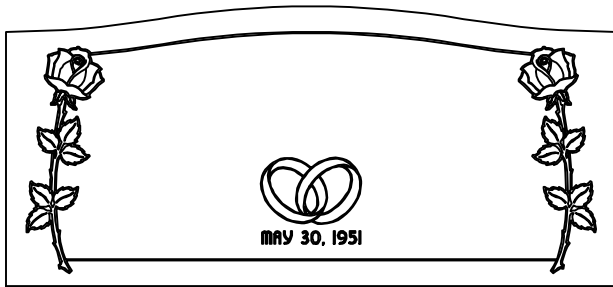

AG-S-29

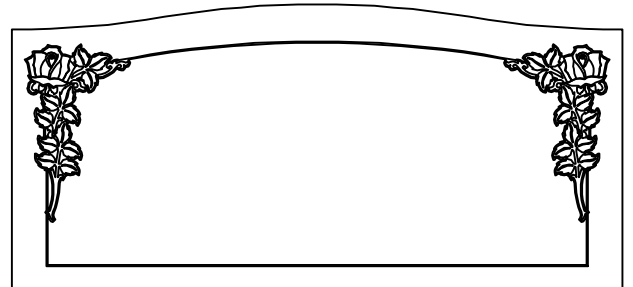

AG-S-30

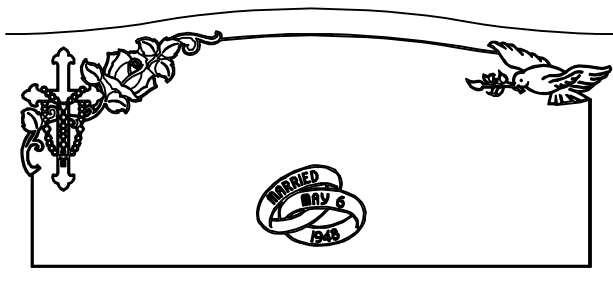

AG-S-31

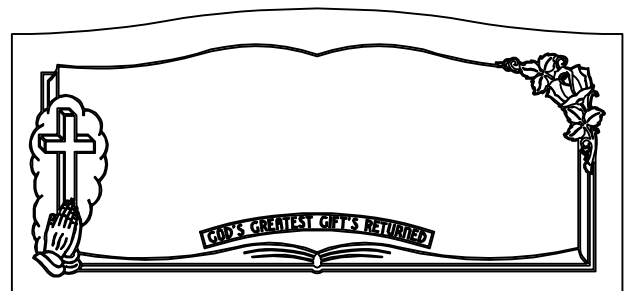

AG-S-32

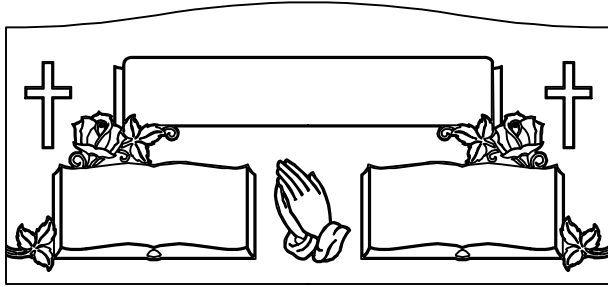

AG-S-33

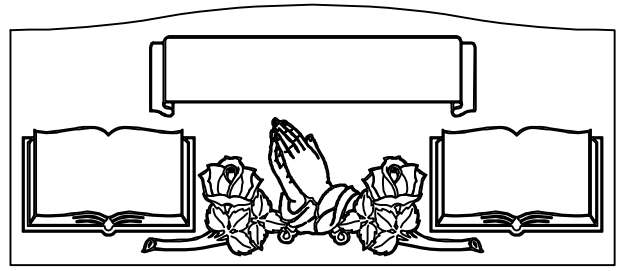

AG-S-34

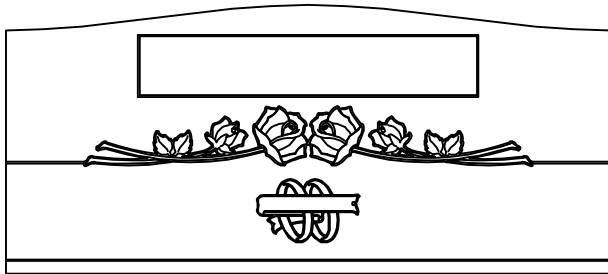

AG-S-35

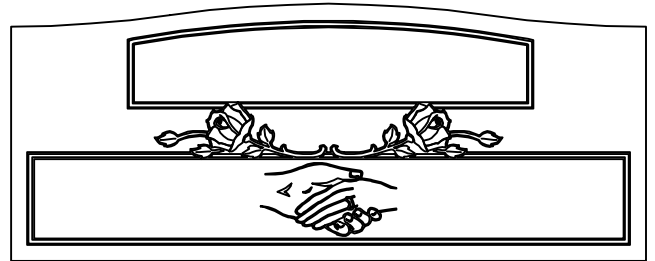

AG-S-36

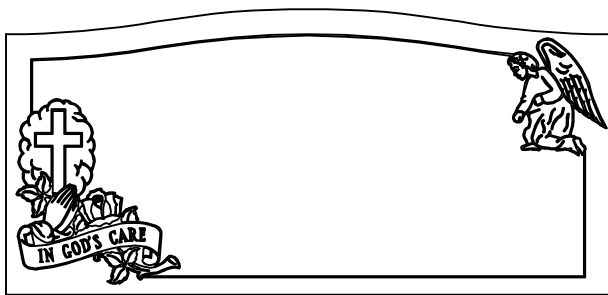

AG-S-37

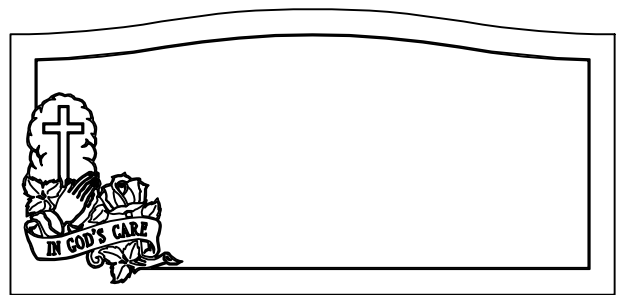

AG-S-38

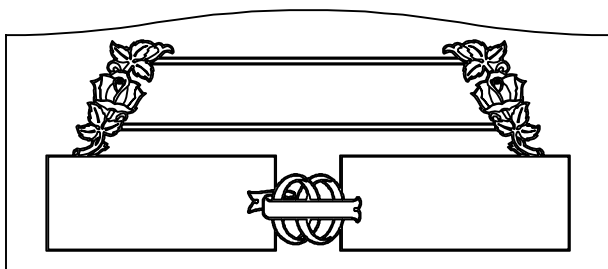

AG-S-39

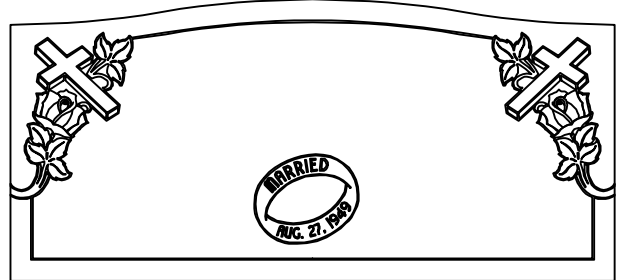

AG-S-40

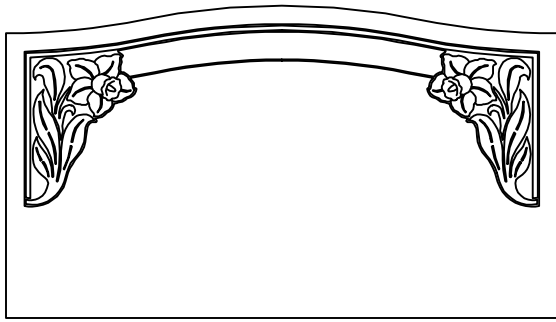

AG-S-41

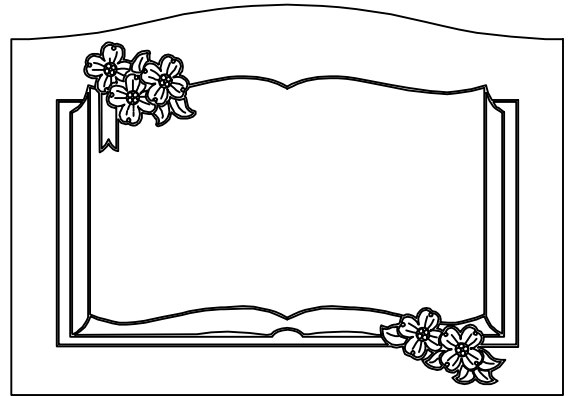

AG-S-42

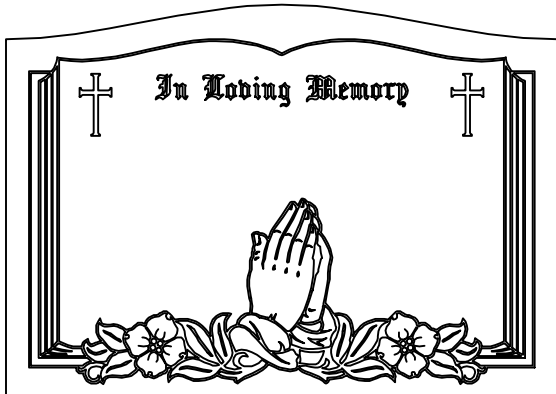

AG-S-43

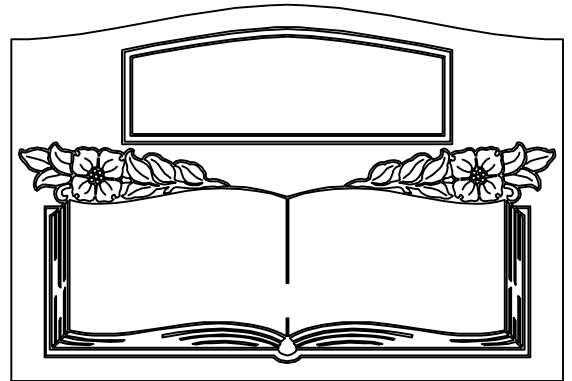

AG-S-44

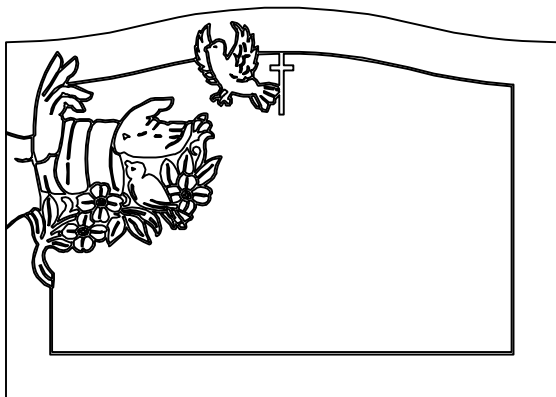

AG-S-45

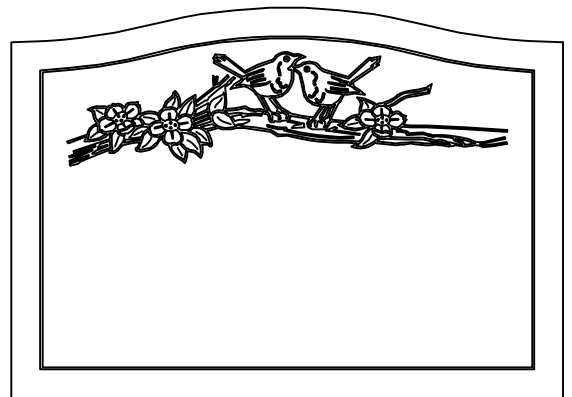

AG-S-46

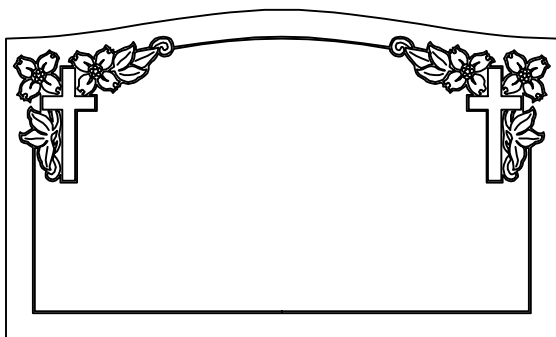

AG-S-47

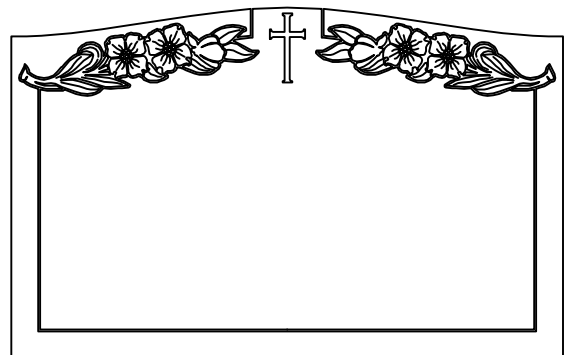

AG-S-48

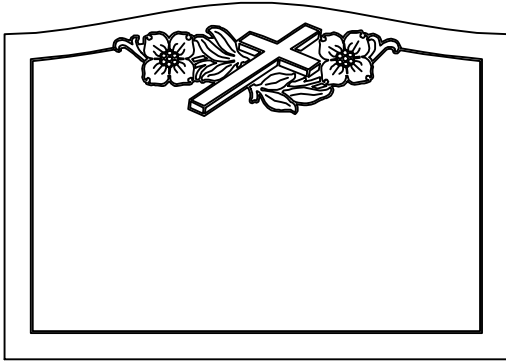

AG-S-49

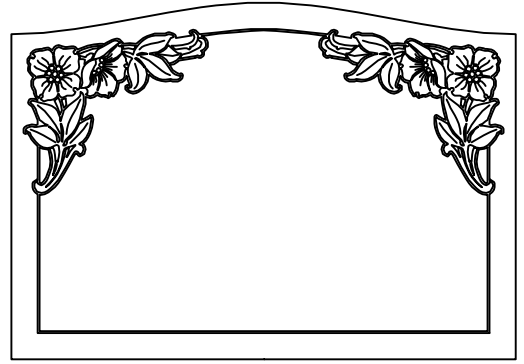

AG-S-50

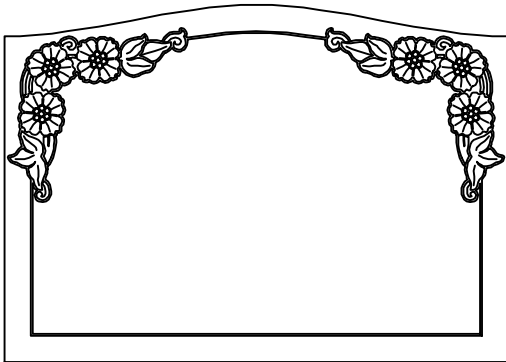

AG-S-51

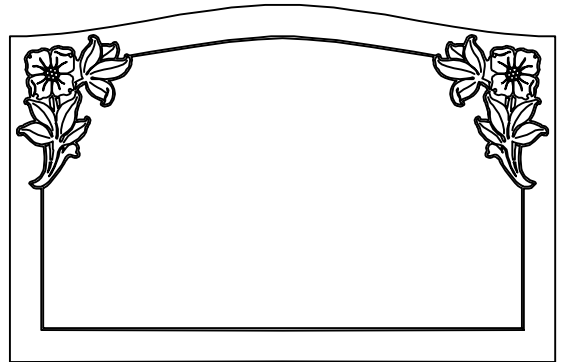

AG-S-52

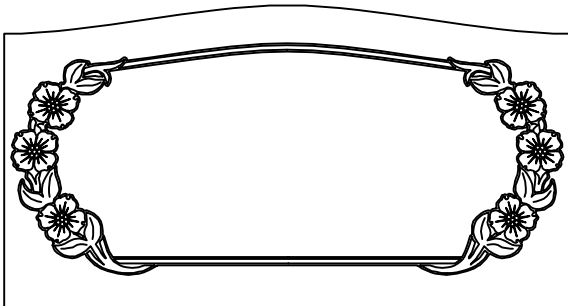

AG-S-53

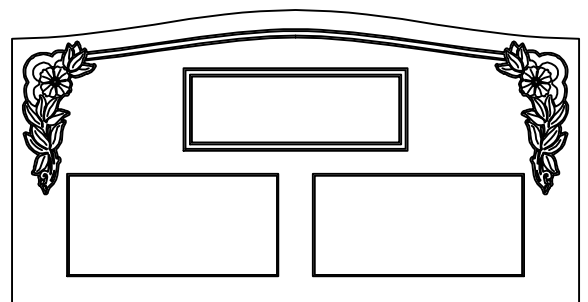

AG-S-54

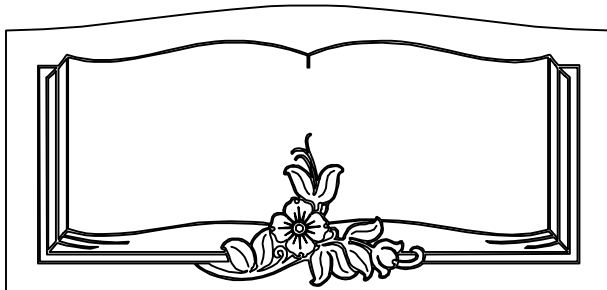

AG-S-55

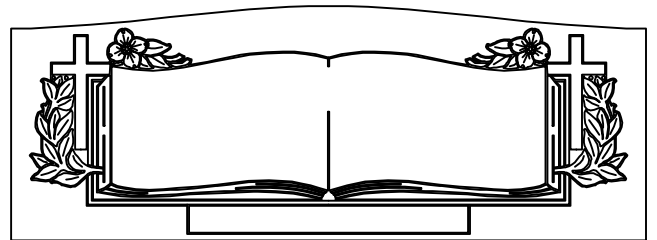

AG-S-56

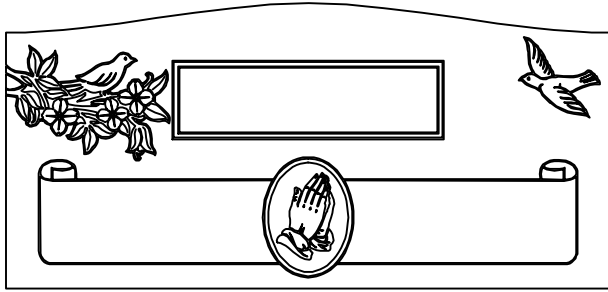

AG-S-57

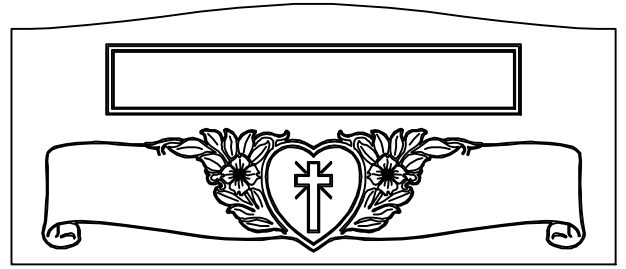

AG-S-58

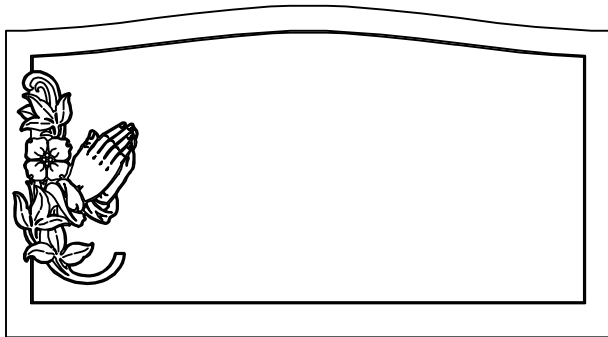

AG-S-59

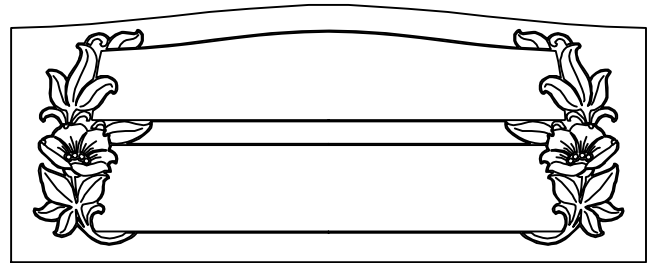

AG-S-60

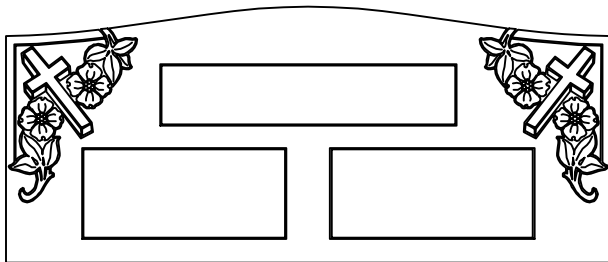

AG-S-61

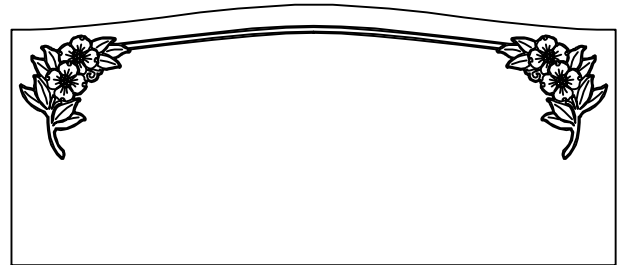

AG-S-62

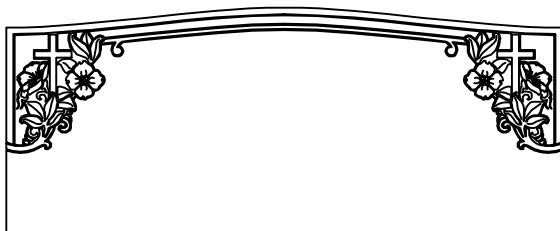

AG-S-63

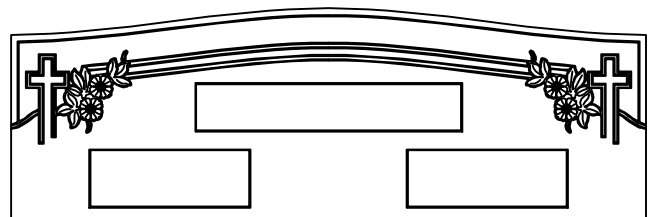

AG-S-64

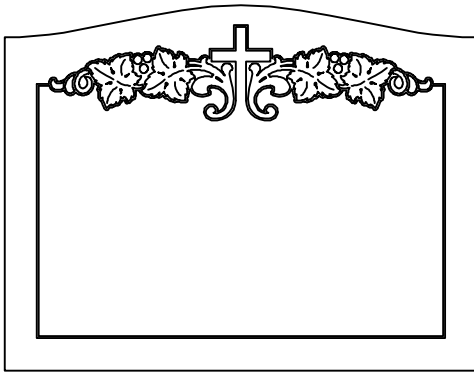

AG-S-65

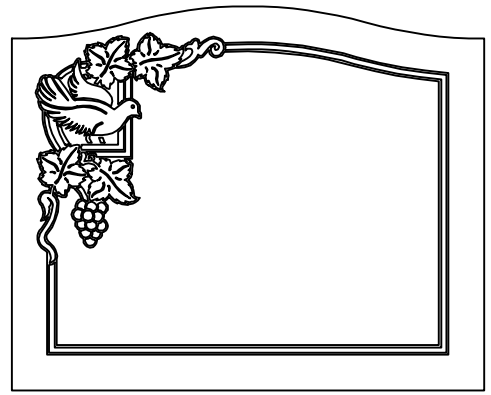

AG-S-66

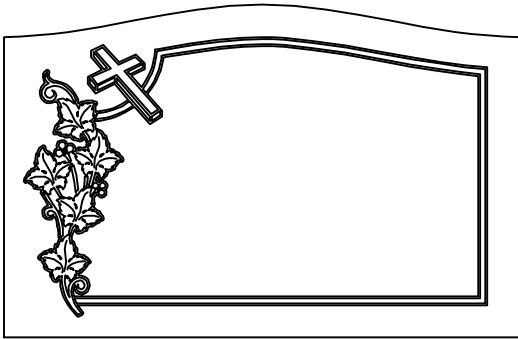

AG-S-67

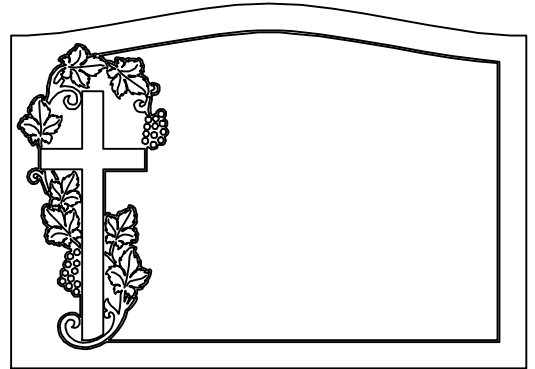

AG-S-68

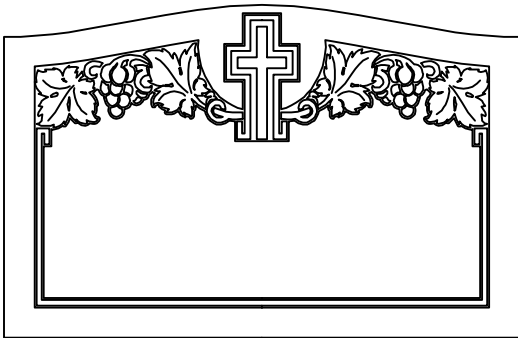

AG-S-69

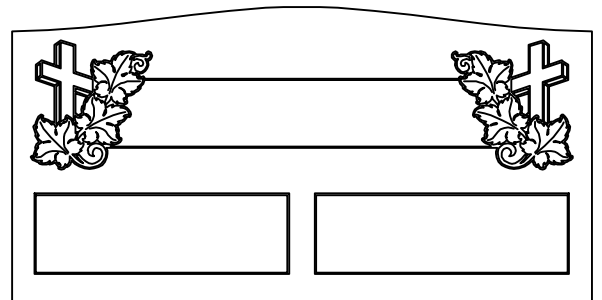

AG-S-70

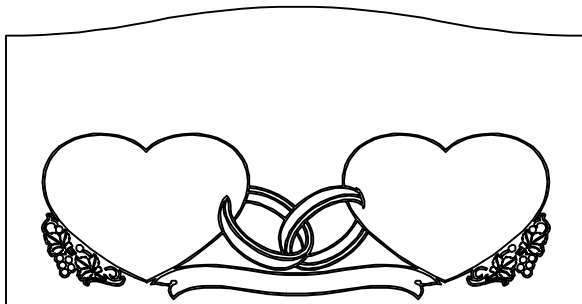

AG-S-71

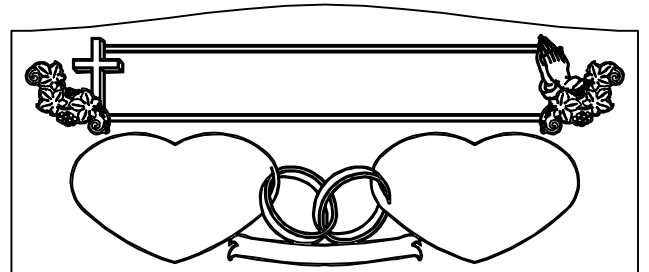

AG-S-72

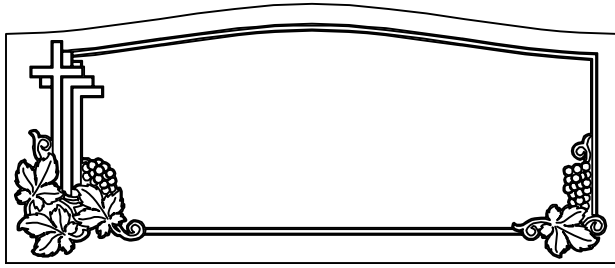

AG-S-73

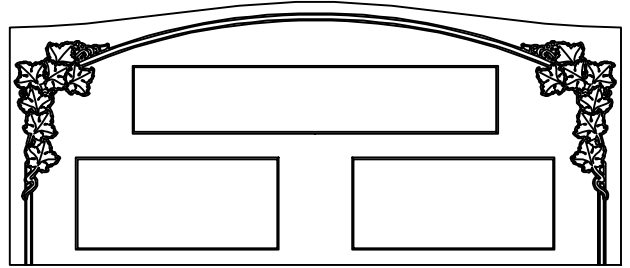

AG-S-74

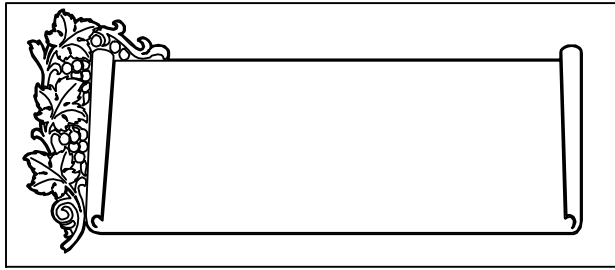

AG-S-75

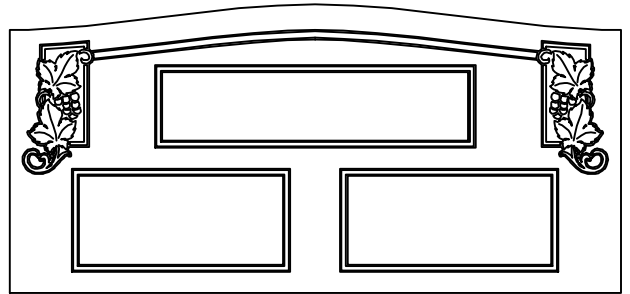

AG-S-76

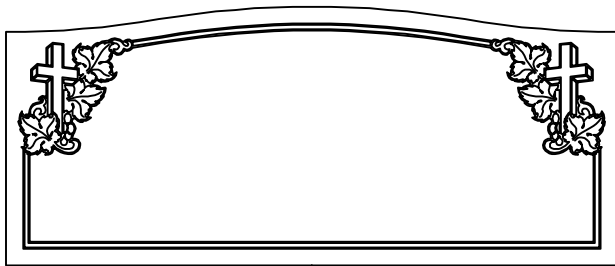

AG-S-77

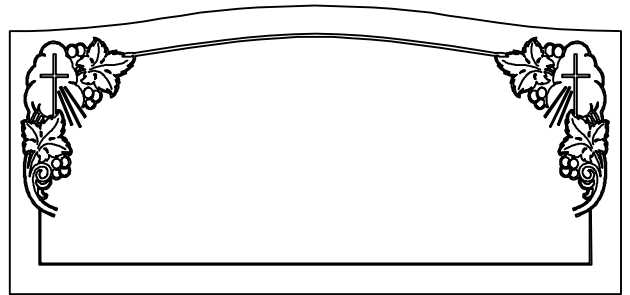

AG-S-78

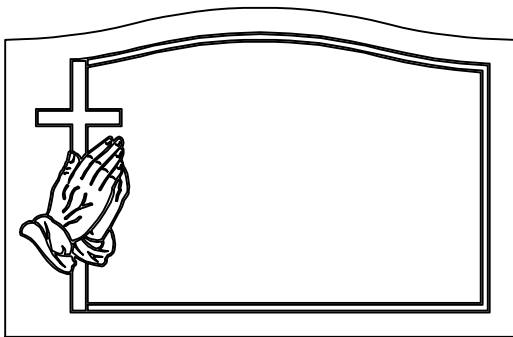

AG-S-79

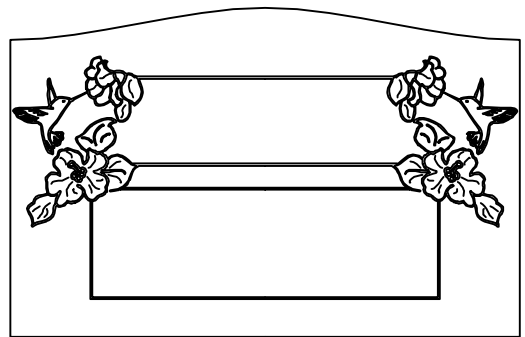

AG-S-80

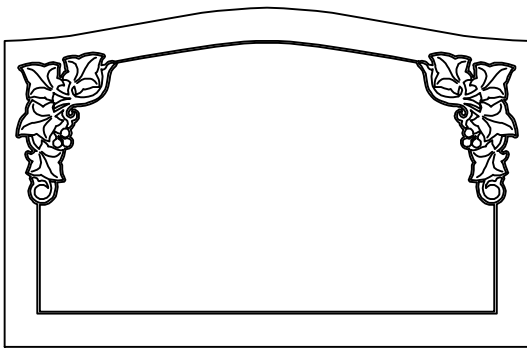

AG-S-81

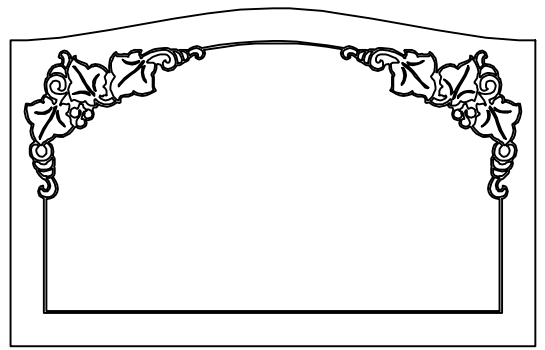

AG-S-82

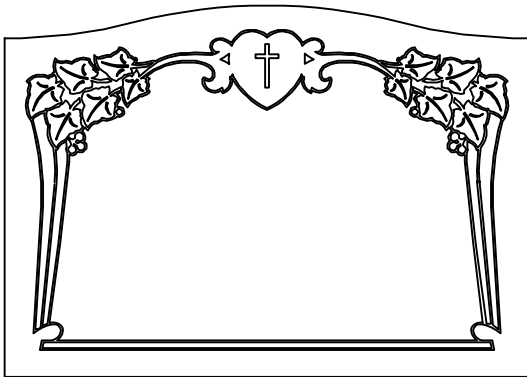

AG-S-83

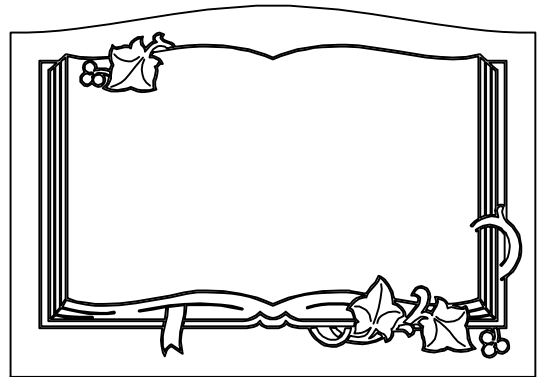

AG-S-84

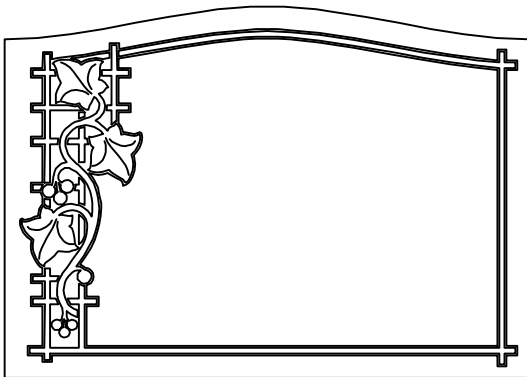

AG-S-85

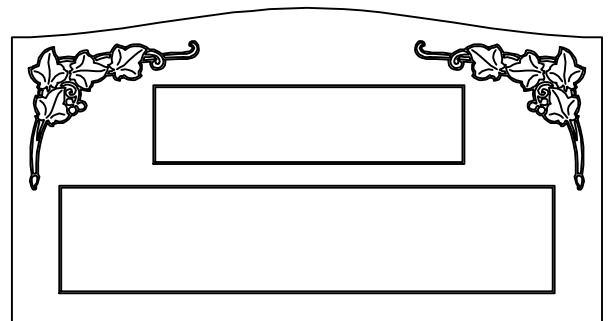

AG-S-86

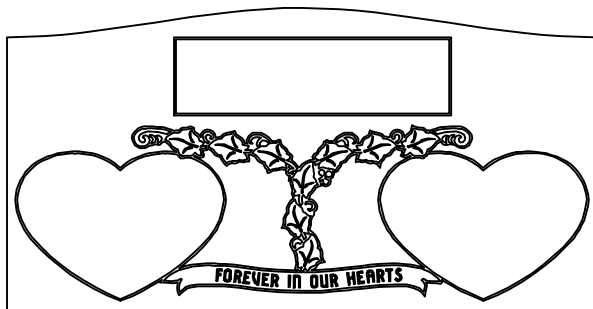

AG-S-87

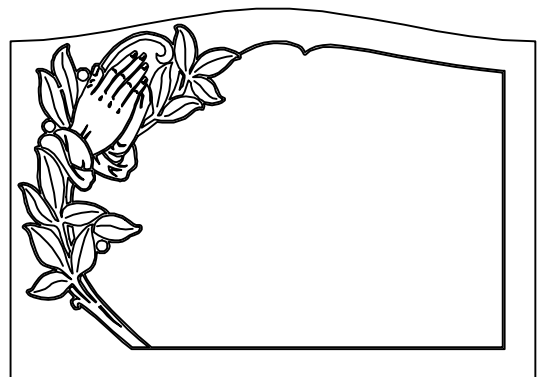

AG-S-88

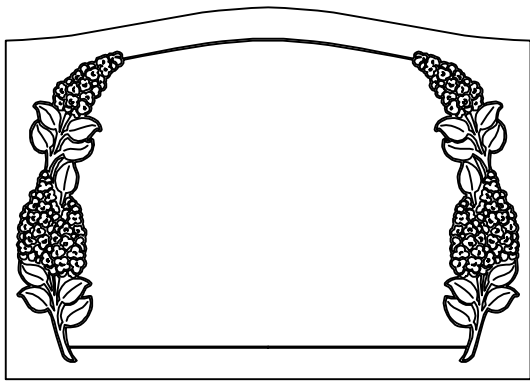

AG-S-89

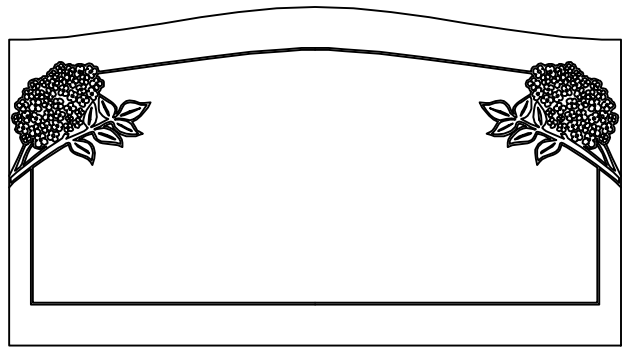

AG-S-90

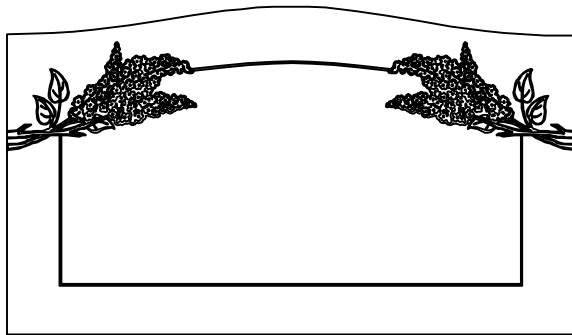

AG-S-91

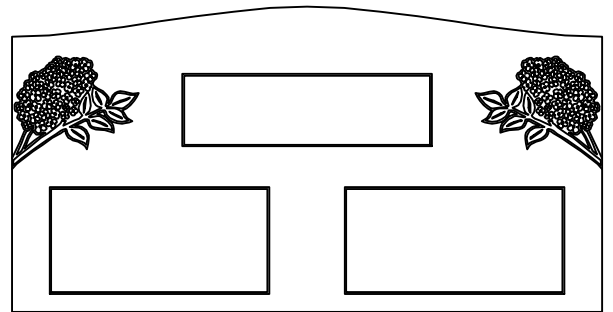

AG-S-92

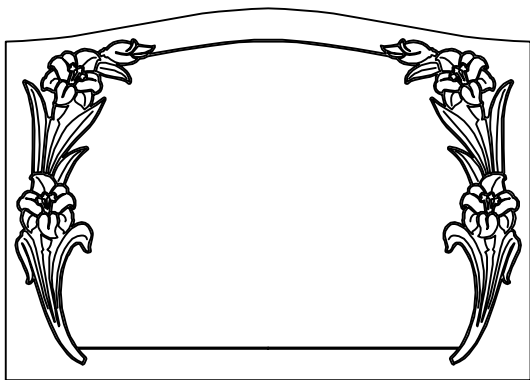

AG-S-93

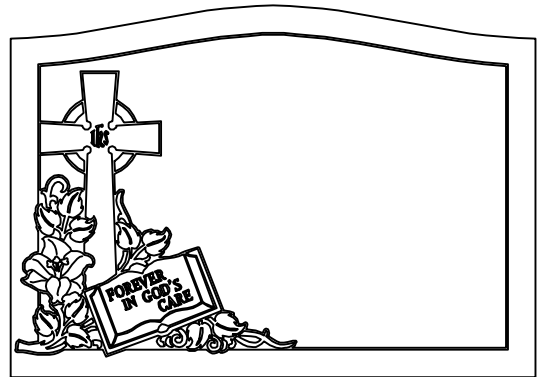

AG-S-94

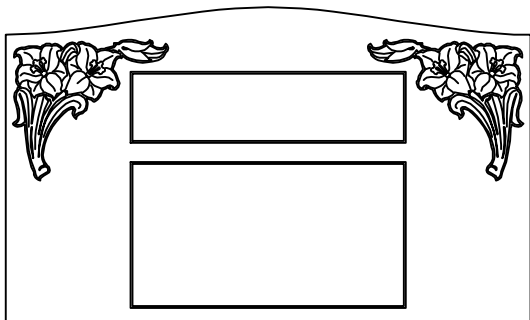

AG-S-95

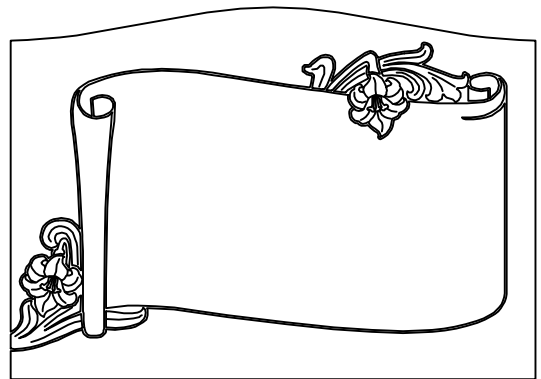

AG-S-96

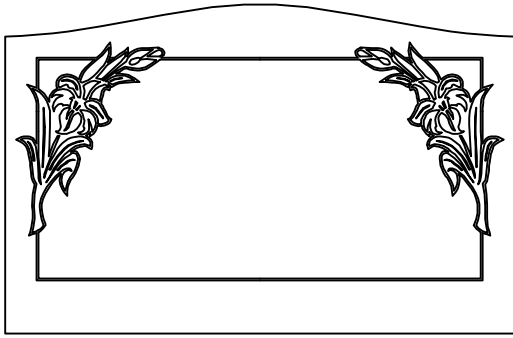

AG-S-97

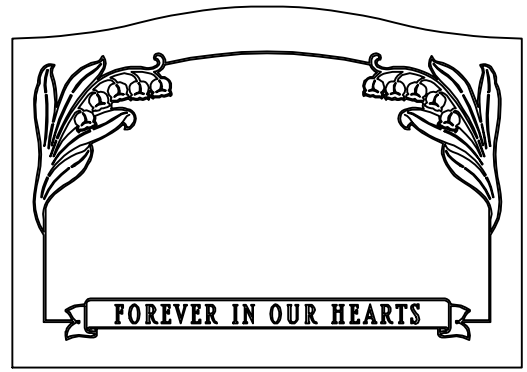

AG-S-98

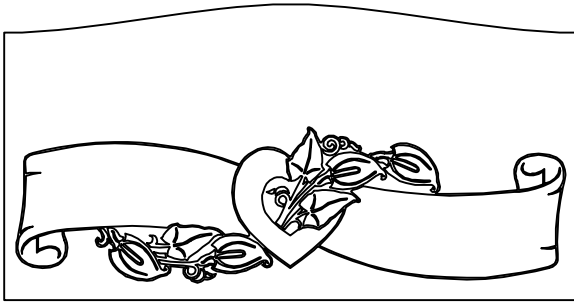

AG-S-99

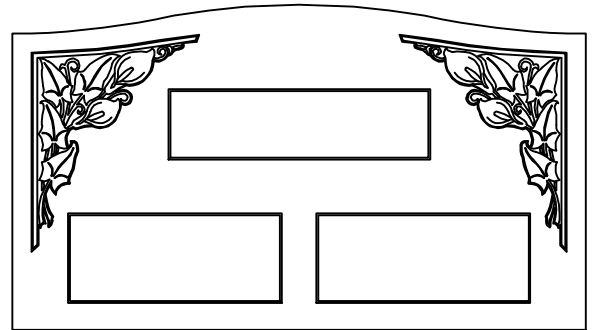

AG-S-100

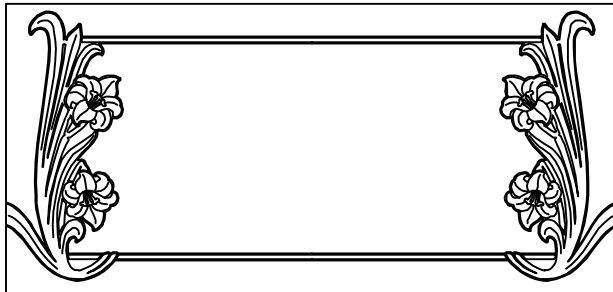

AG-S-101

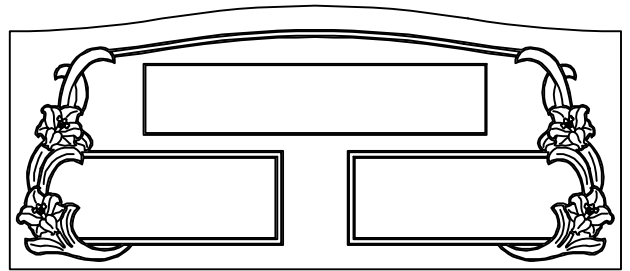

AG-S-102

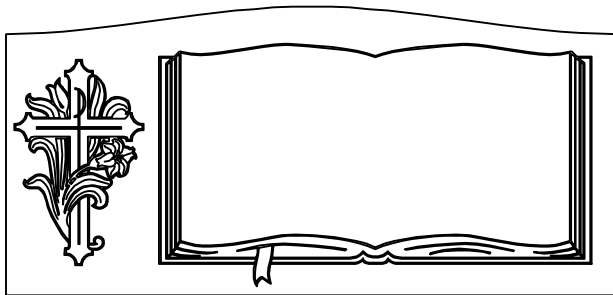

AG-S-103

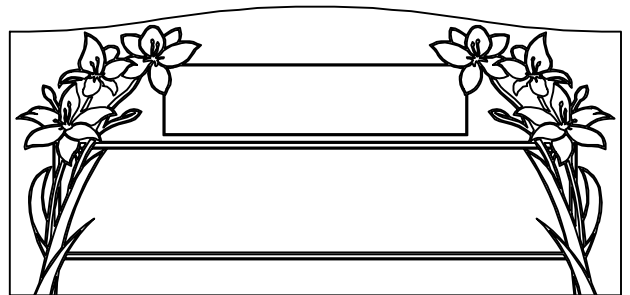

AG-S-104

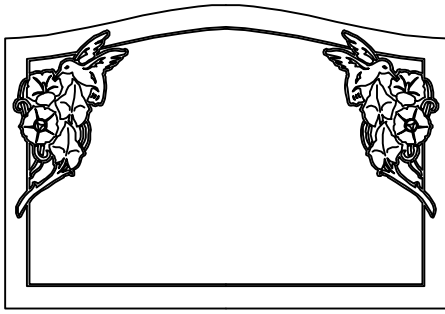

AG-S-105

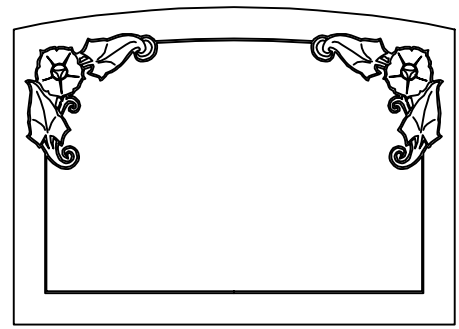

AG-S-106

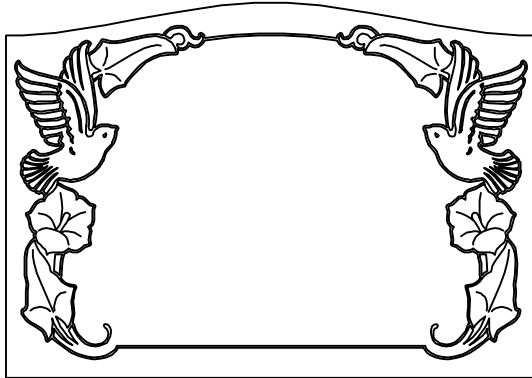

AG-S-107

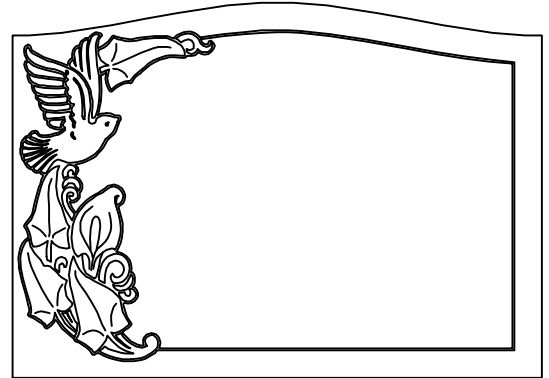

AG-S-108

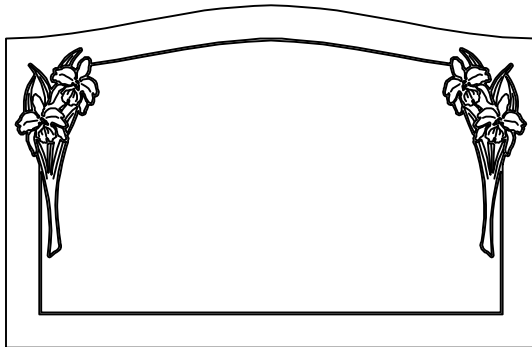

AG-S-109

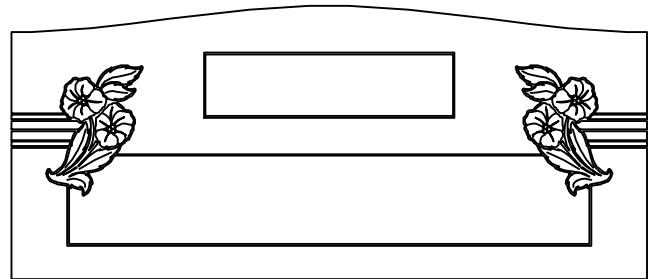

AG-S-110

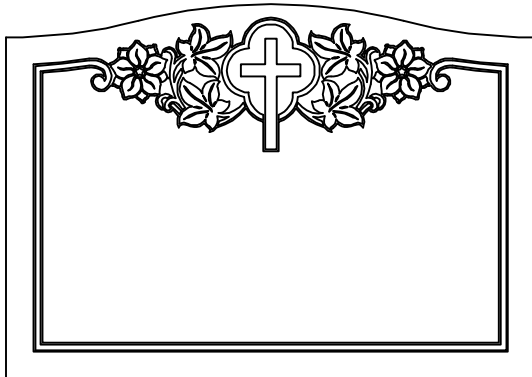

AG-S-111

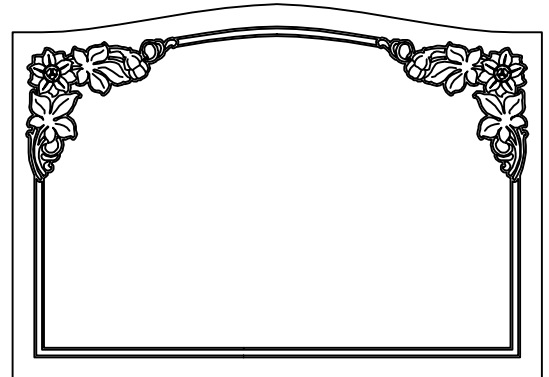

AG-S-112

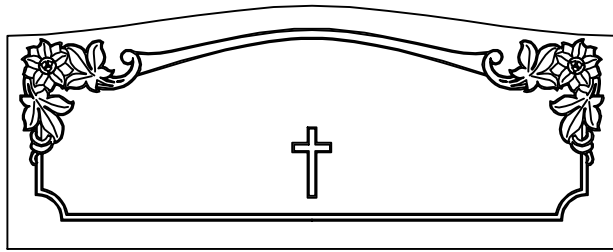

AG-S-113

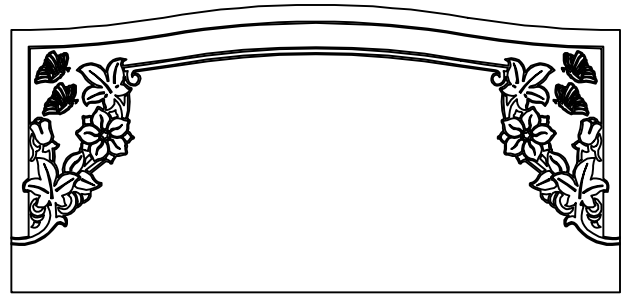

AG-S-114

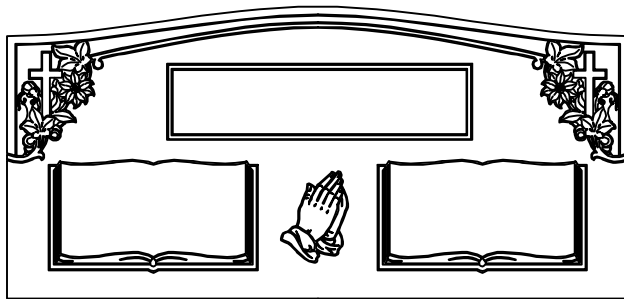

AG-S-115

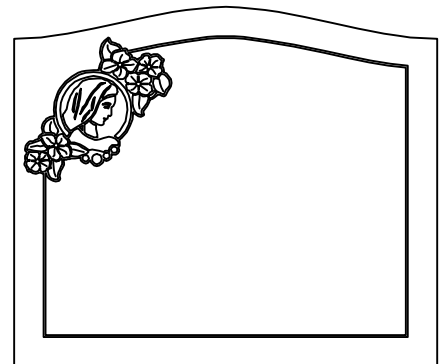

AG-S-116

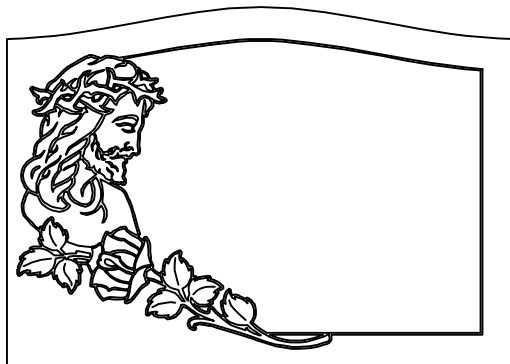

AG-S-117

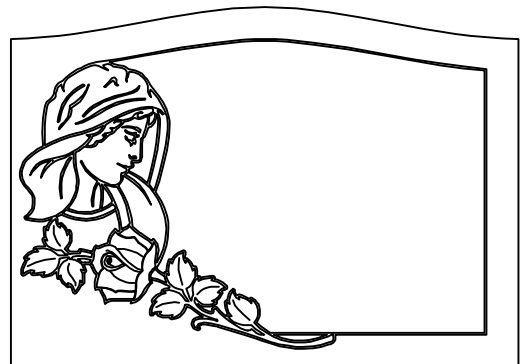

AG-S-118

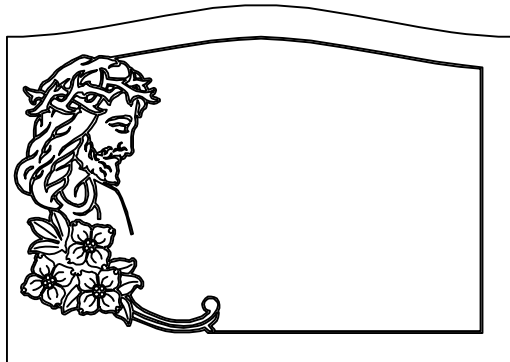

AG-S-119

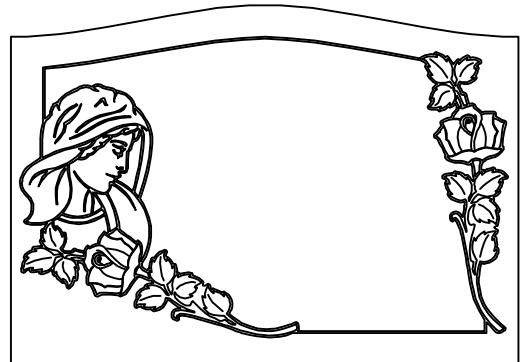

AG-S-120

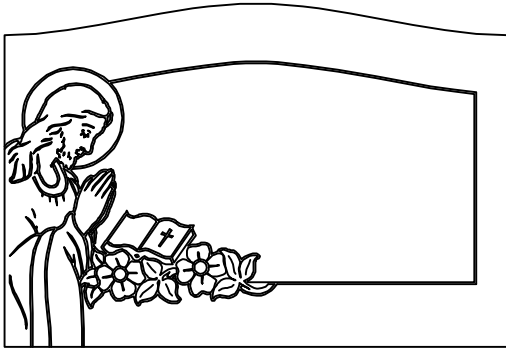

AG-S-121

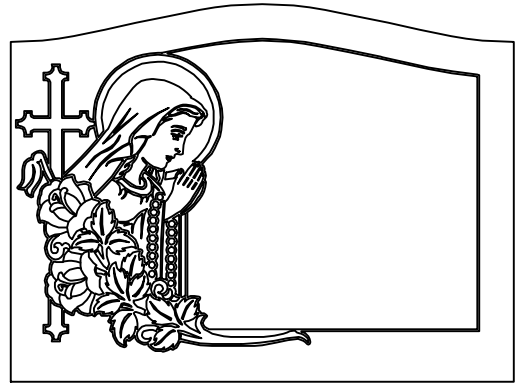

AG-S-122



AG-S-123



AG-S-124

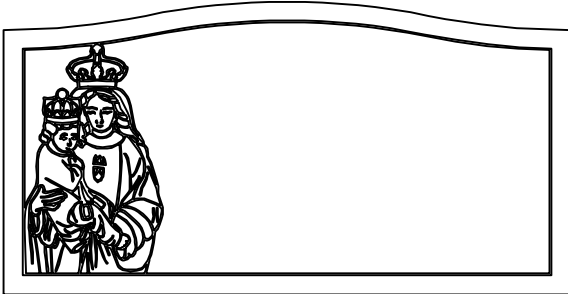

AG-S-125

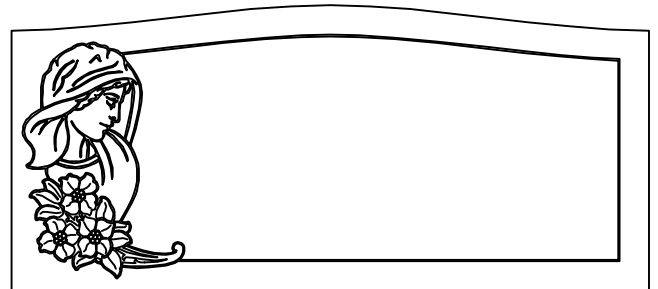

AG-S-126

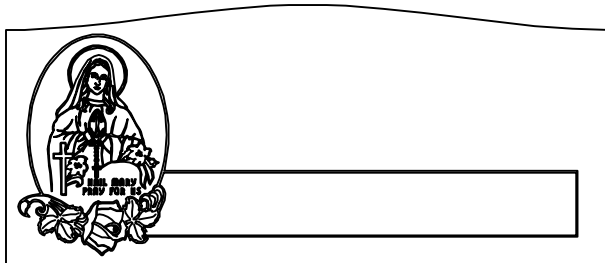

AG-S-127

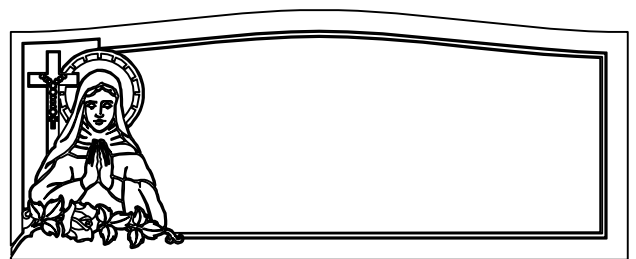

AG-S-128

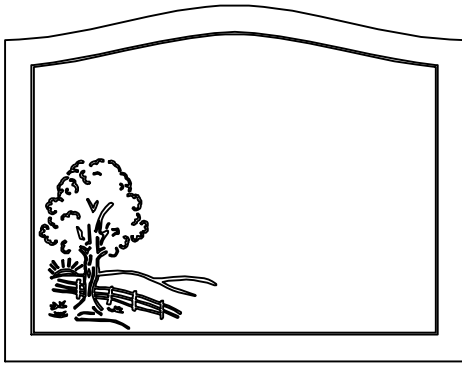

AG-S-129

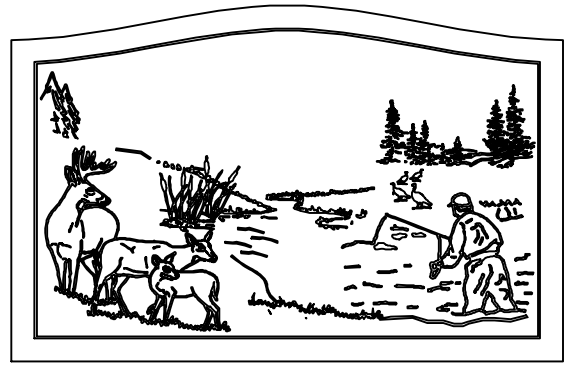

AG-S-130

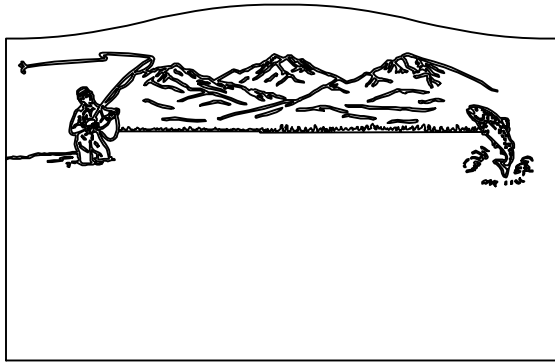

AG-S-131

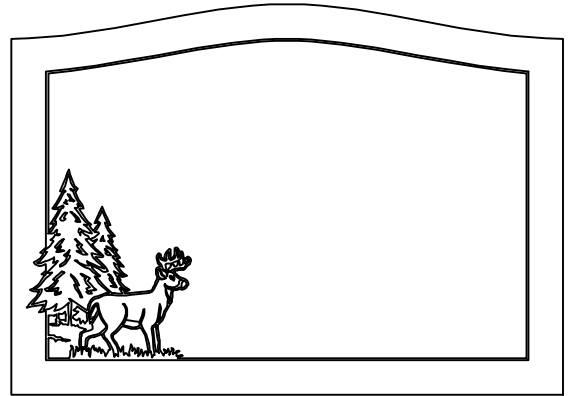

AG-S-132

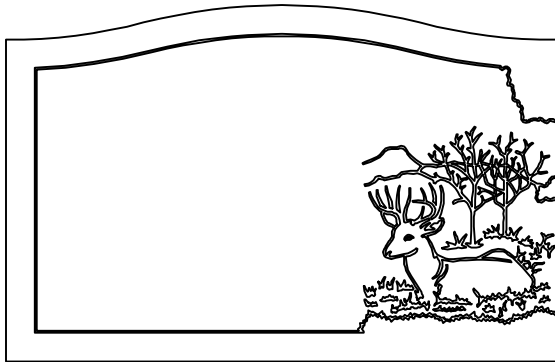

AG-S-133

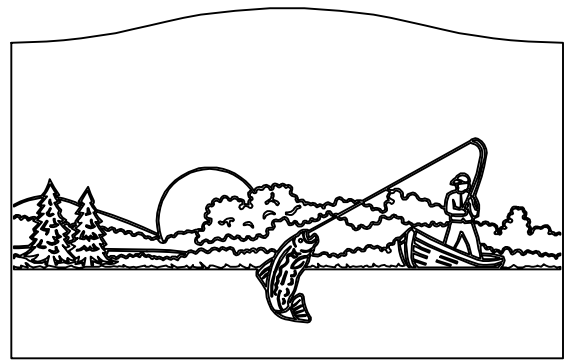

AG-S-134

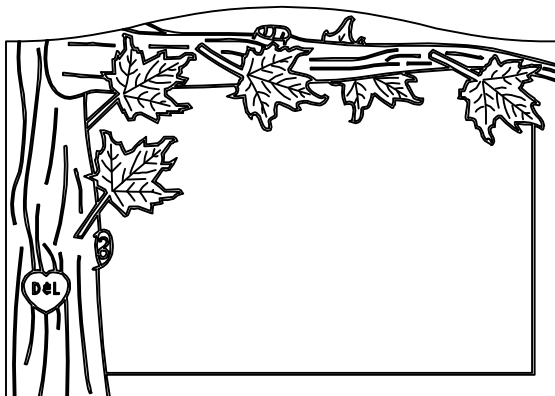

AG-S-135

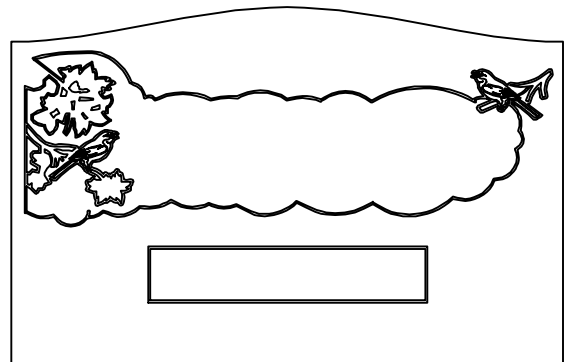

AG-S-136

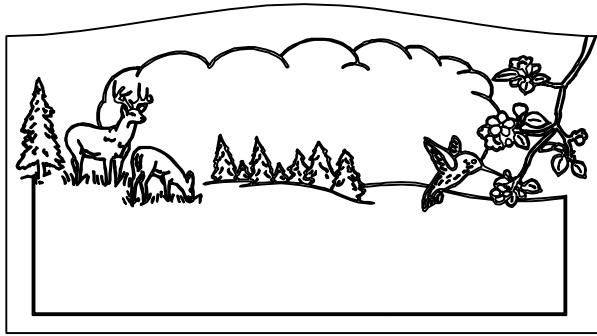

AG-S-137

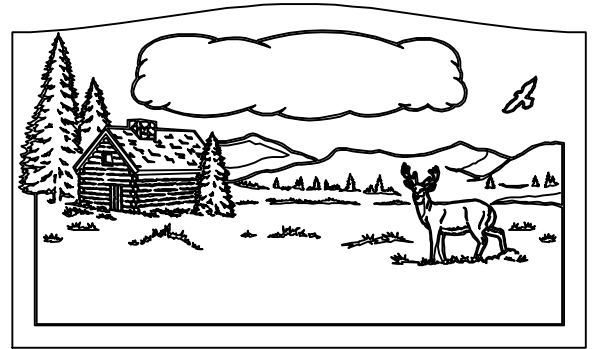

AG-S-138

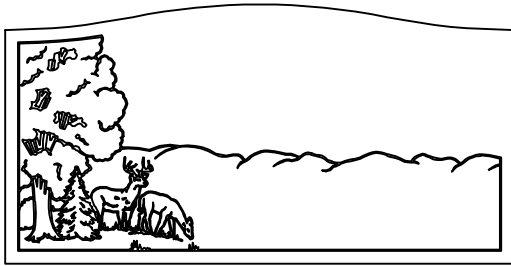

AG-S-139

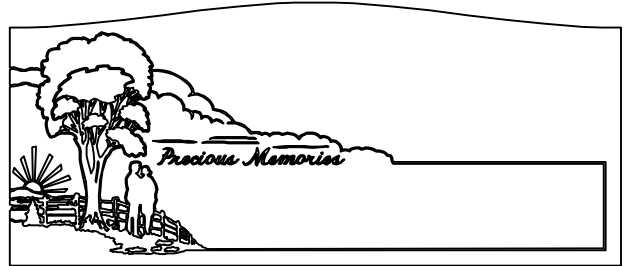

AG-S-140

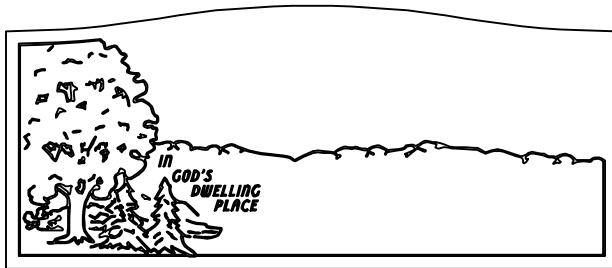

AG-S-141

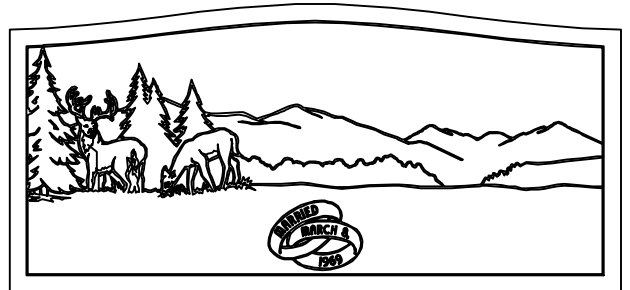

AG-S-142

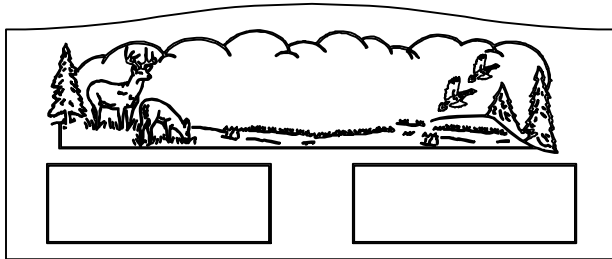

AG-S-143

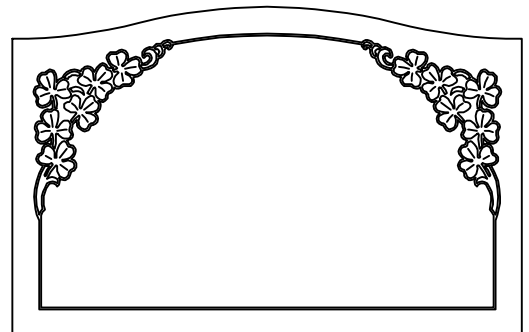

AG-S-144

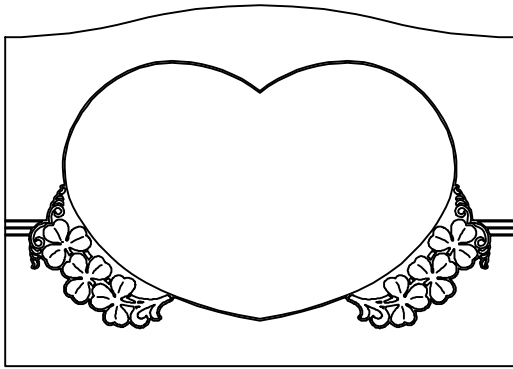

AG-S-145

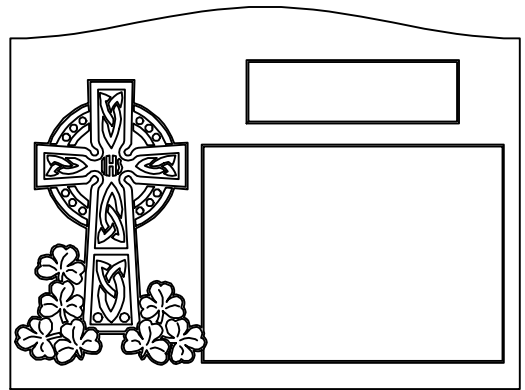

AG-S-146

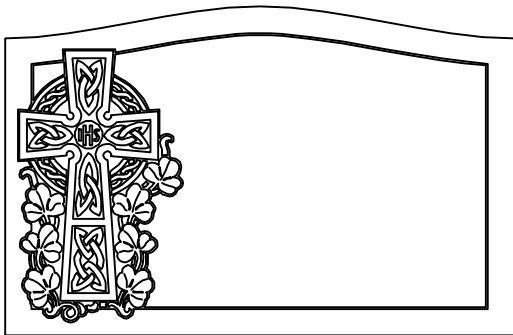

AG-S-147

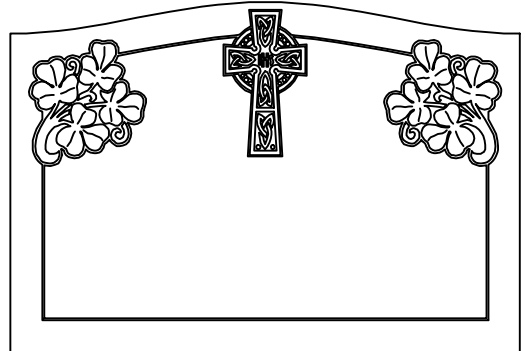

AG-S-148

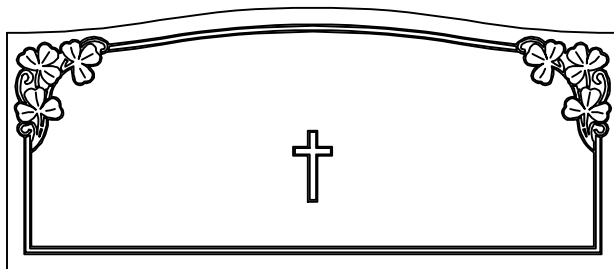

AG-S-149

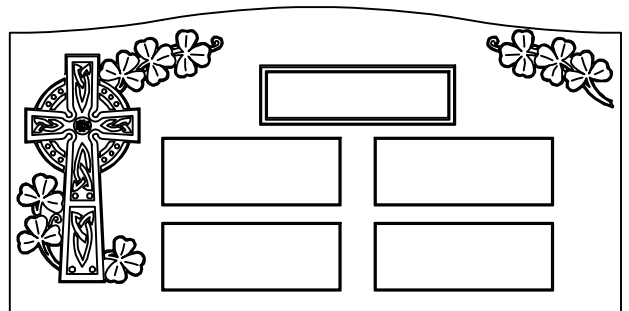

AG-S-150

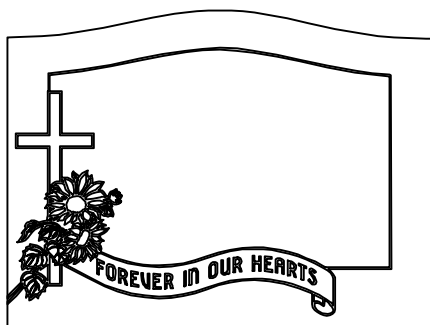

AG-S-151

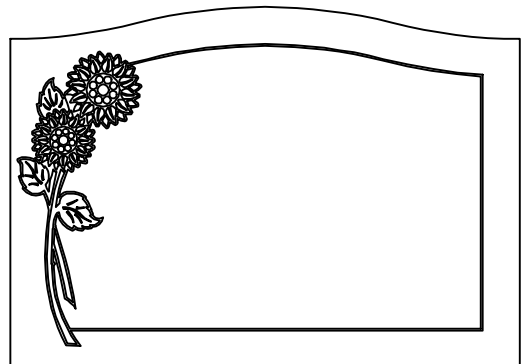

AG-S-152

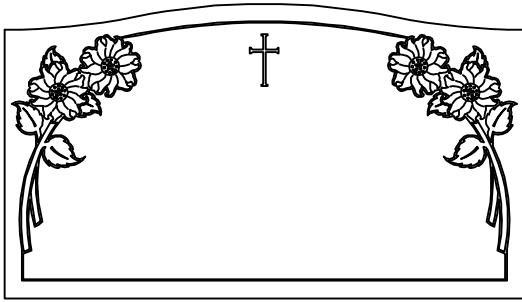

AG-S-153

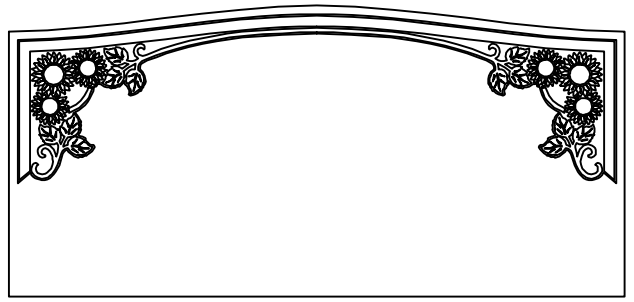

AG-S-154

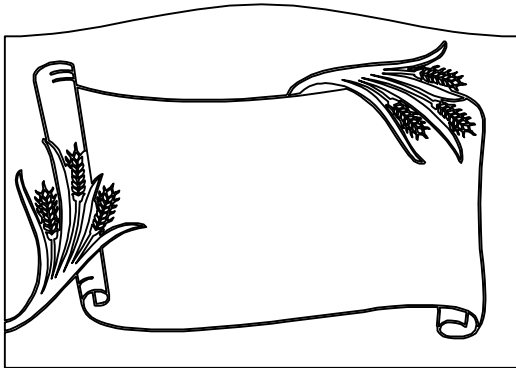

AG-S-155

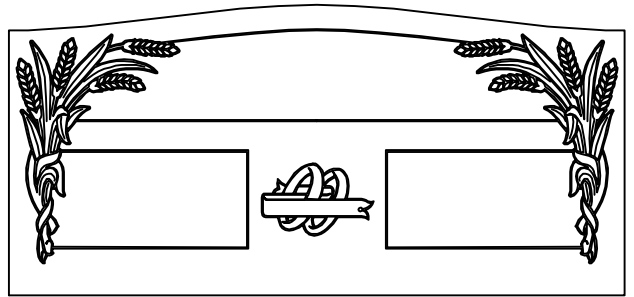

AG-S-156

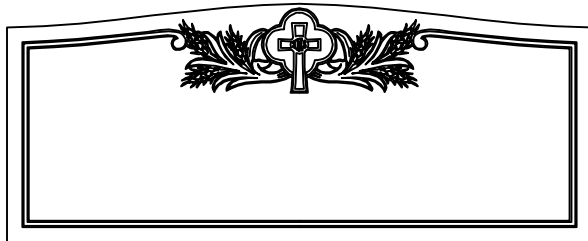

AG-S-157

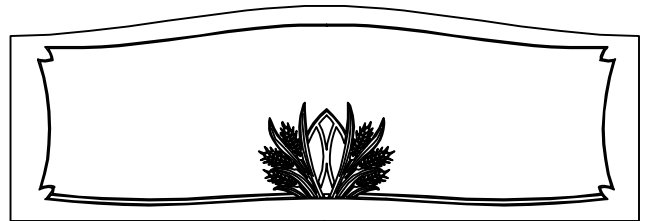

AG-S-158

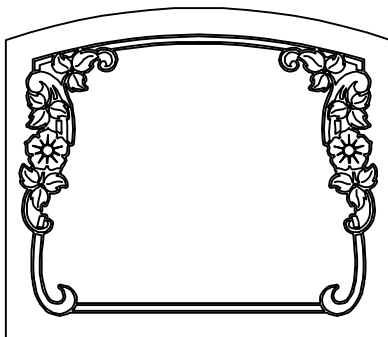

AG-S-159

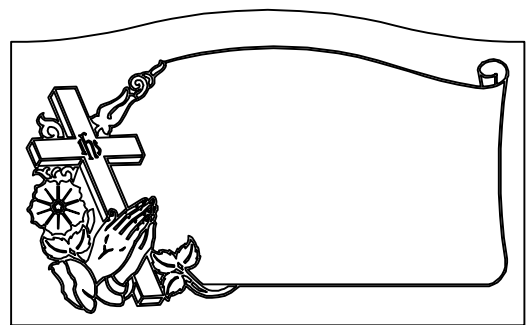

AG-S-160

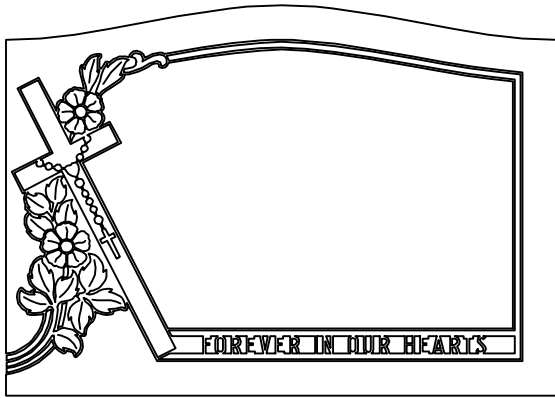

AG-S-161

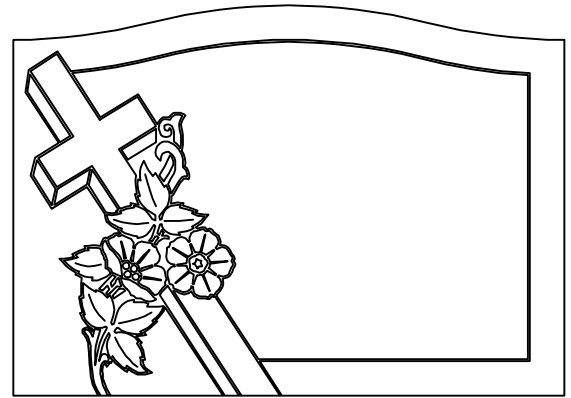

AG-S-162

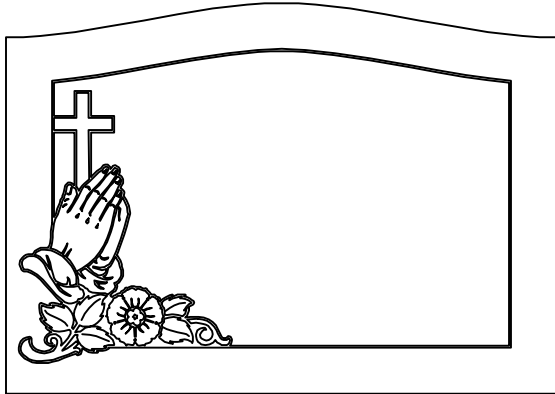

AG-S-163

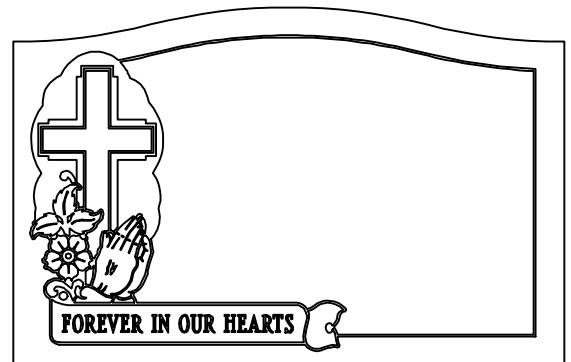

AG-S-164

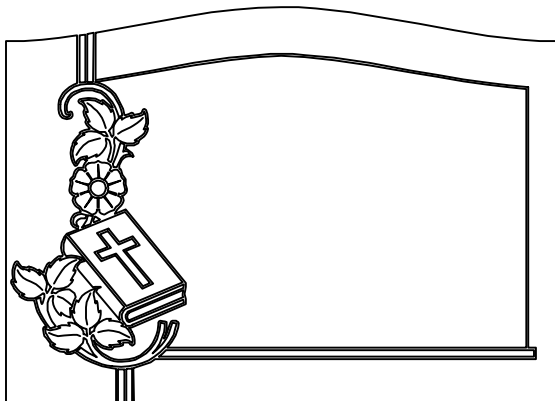

AG-S-165

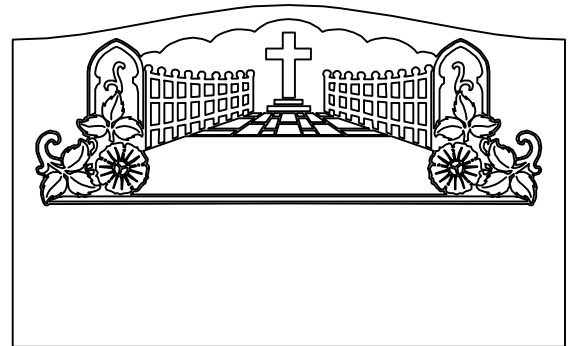

AG-S-166

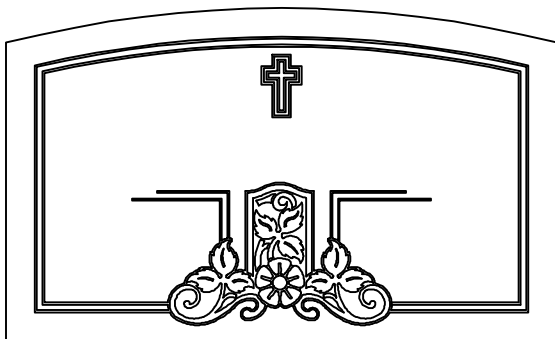

AG-S-167

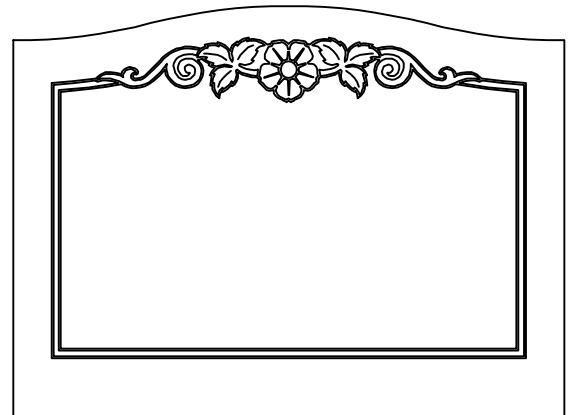

AG-S-168

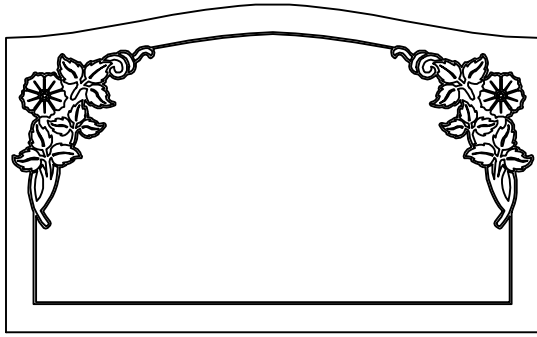

AG-S-169

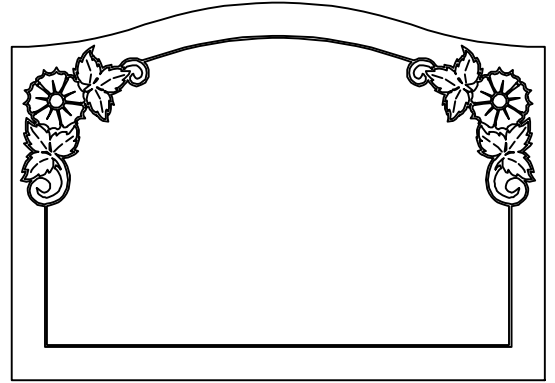

AG-S-170

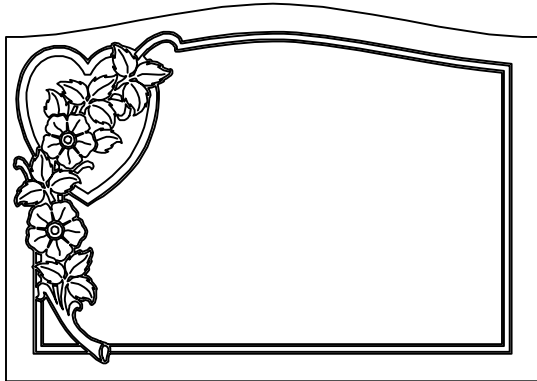

AG-S-171

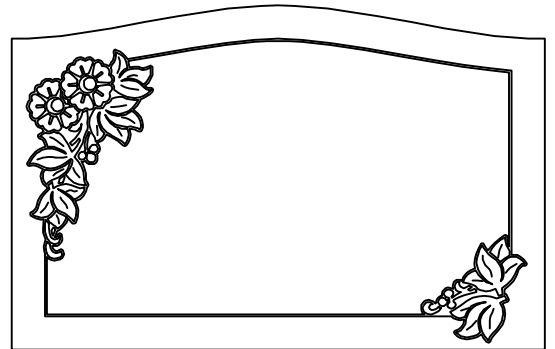

AG-S-172

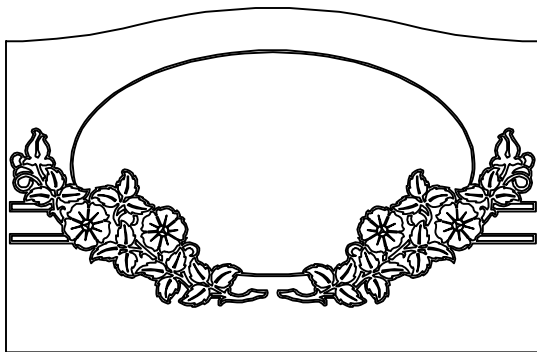

AG-S-173

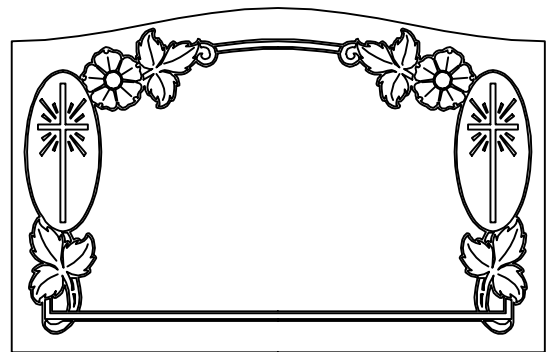

AG-S-174

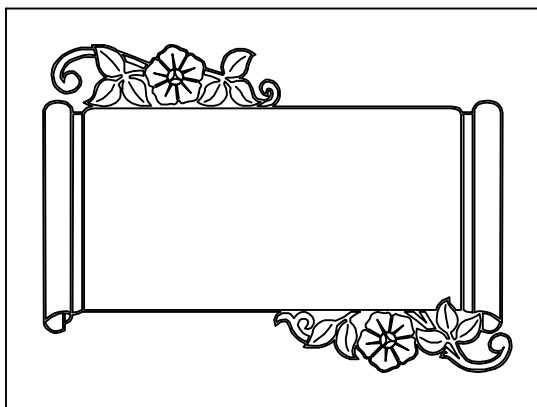

AG-S-175

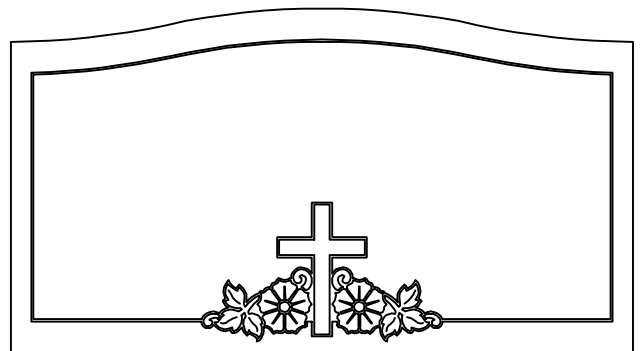

AG-S-176

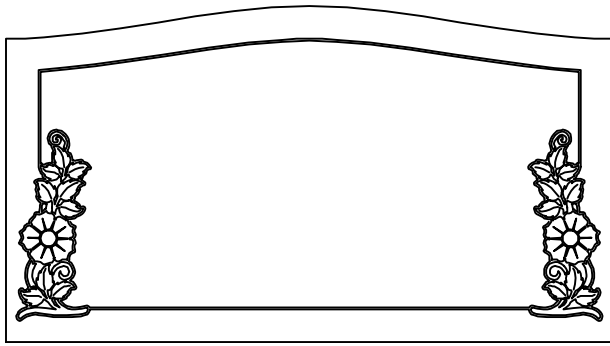

AG-S-177

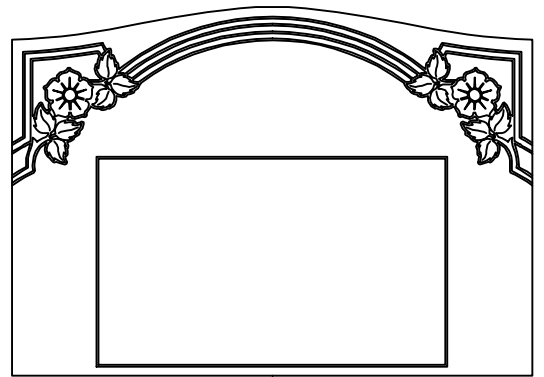

AG-S-178

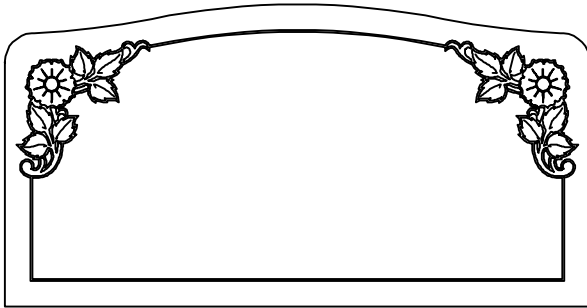

AG-S-179

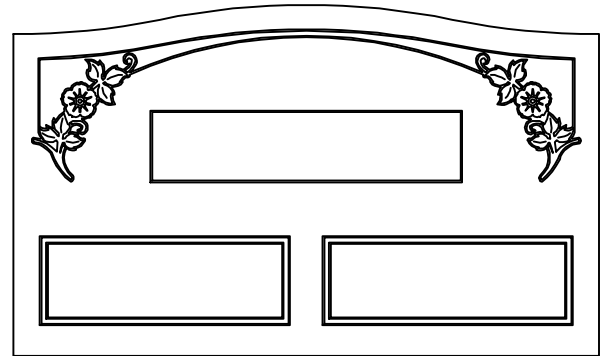

AG-S-180

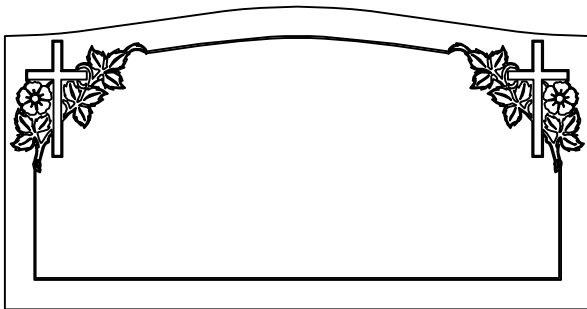

AG-S-181

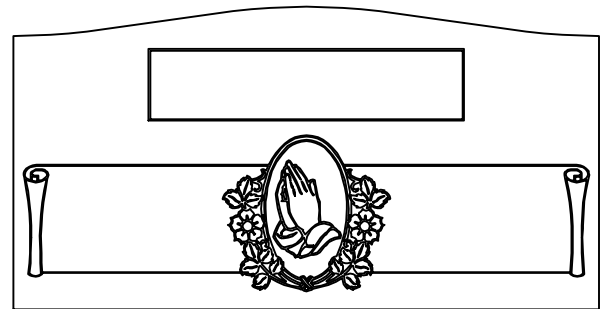

AG-S-182

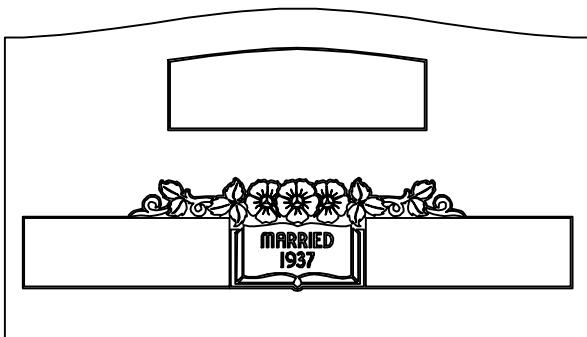

AG-S-183

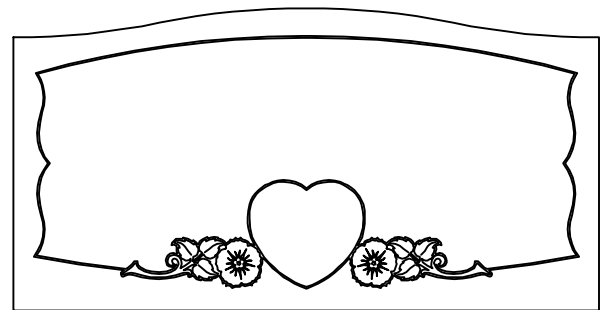

AG-S-184

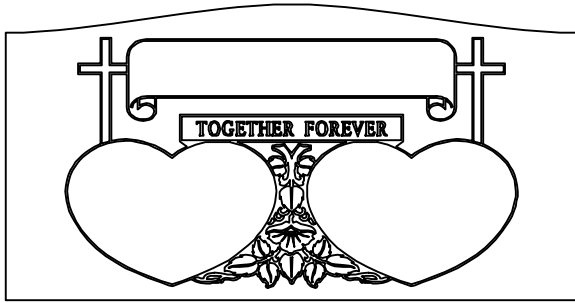

AG-S-185

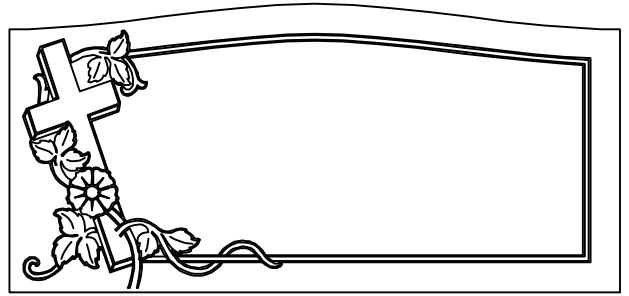

AG-S-186

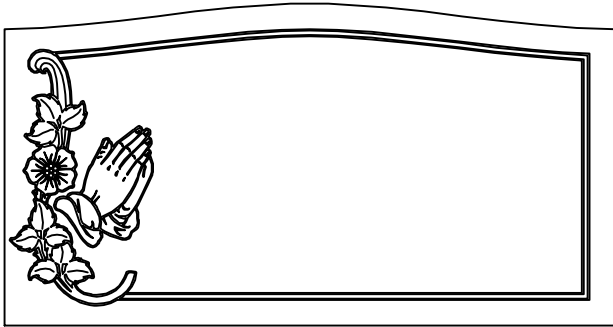

AG-S-187

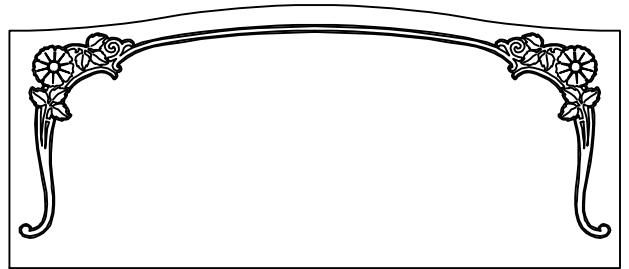

AG-S-188

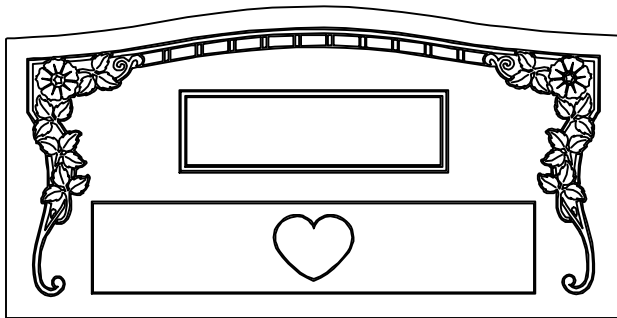

AG-S-189

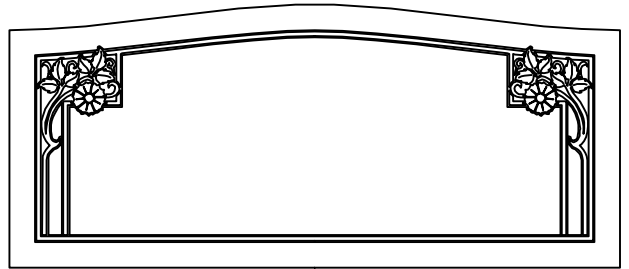

AG-S-190

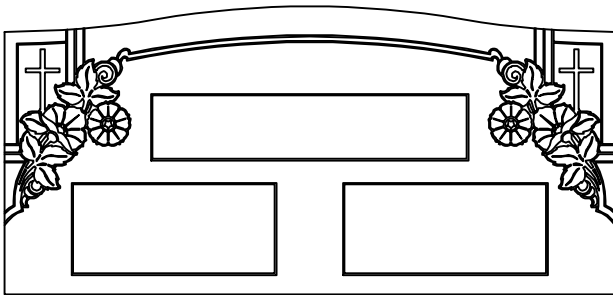

AG-S-191



AG-S-192

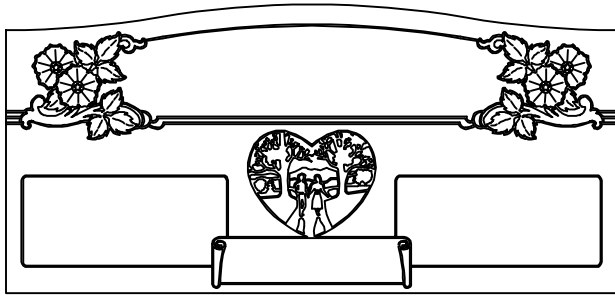

AG-S-193

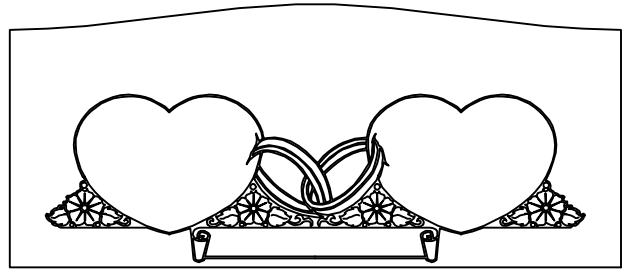

AG-S-194

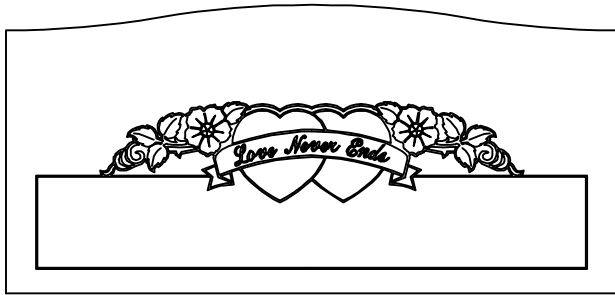

AG-S-195

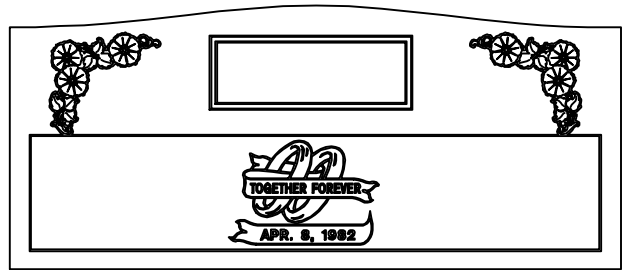

AG-S-196

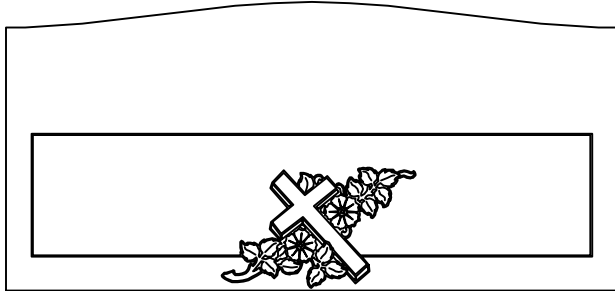

AG-S-197

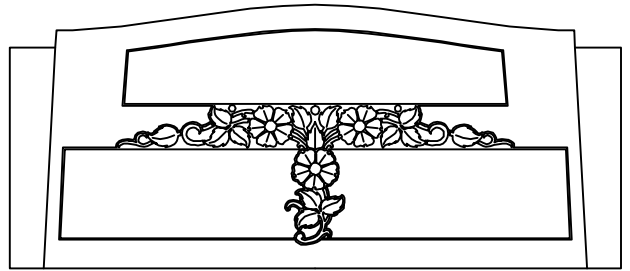

AG-S-198

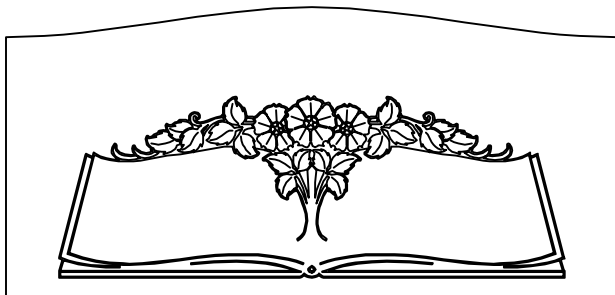

AG-S-199

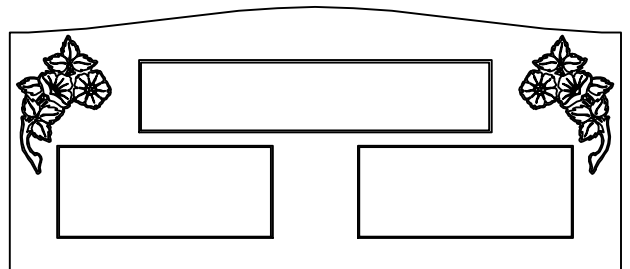

AG-S-200

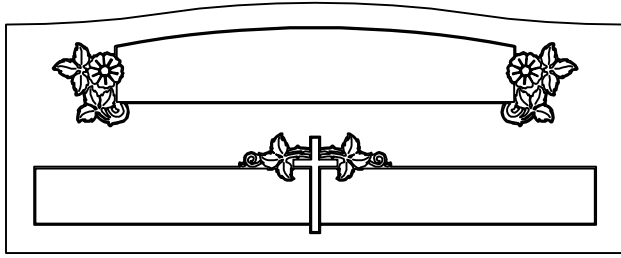

AG-S-201

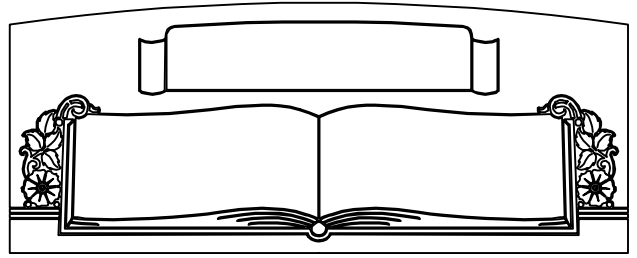

AG-S-202

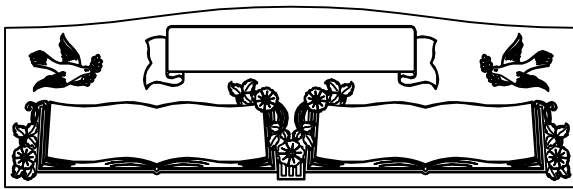

AG-S-203



Markers

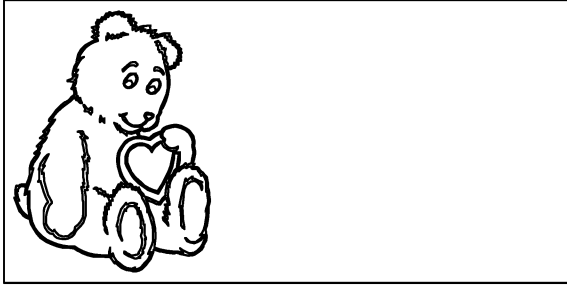

AG-M-01

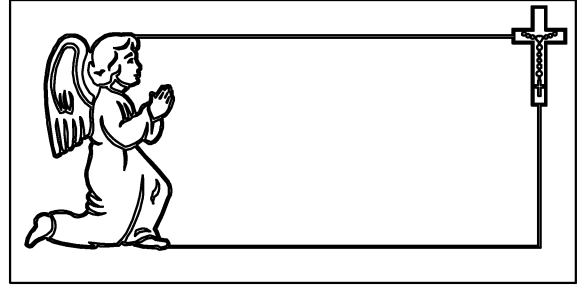

AG-M-02



AG-M-03



AG-M-04

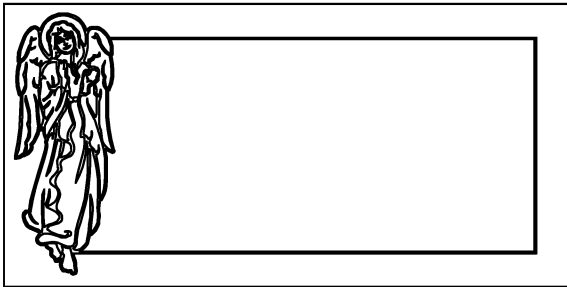

AG-M-05

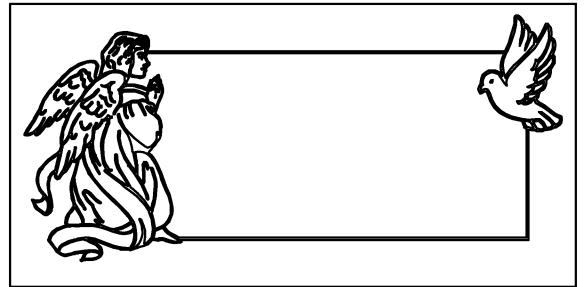

AG-M-06



AG-M-07

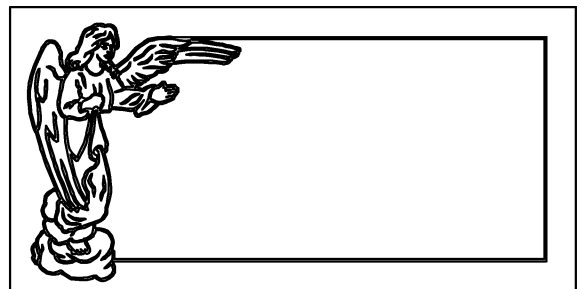

AG-M-08

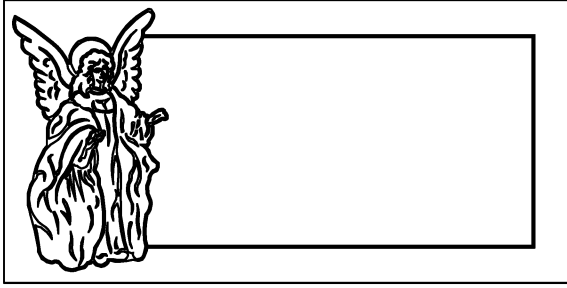

AG-M-09

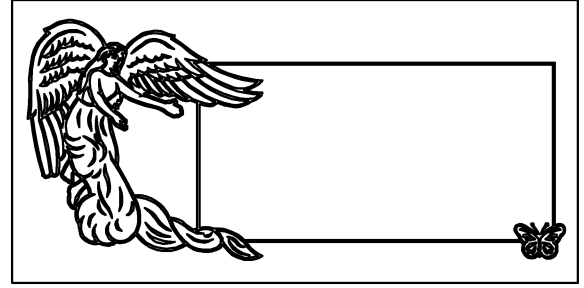

AG-M-10

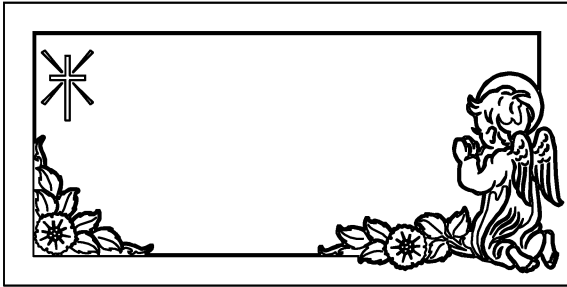

AG-M-11

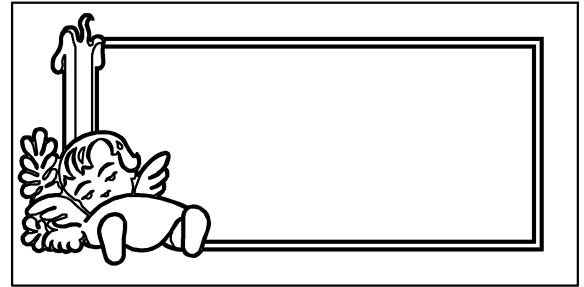

AG-M-12

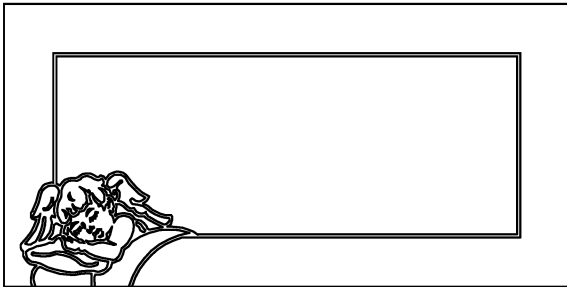

AG-M-13

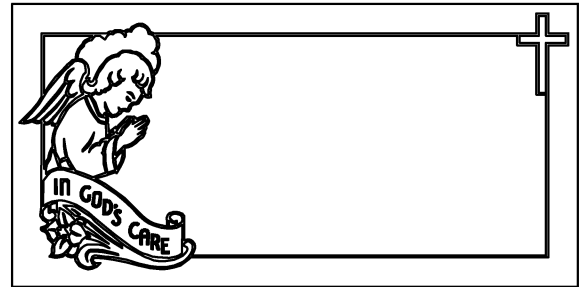

AG-M-14



AG-M-15

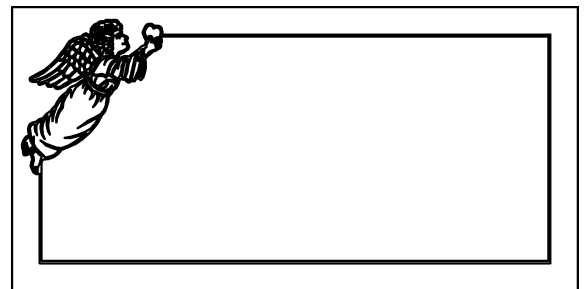

AG-M-16

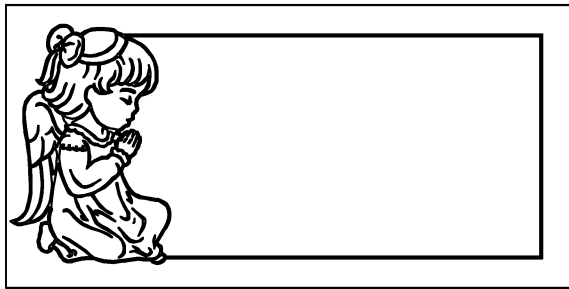

AG-M-17

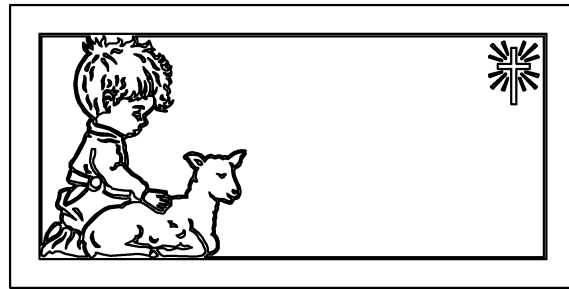

AG-M-18

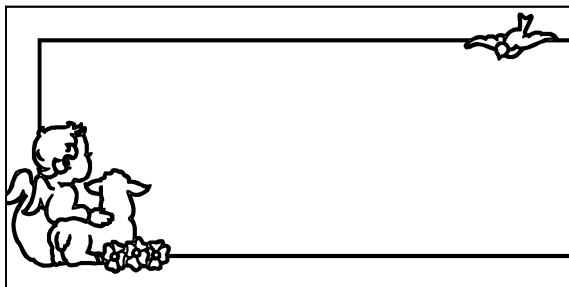

AG-M-19

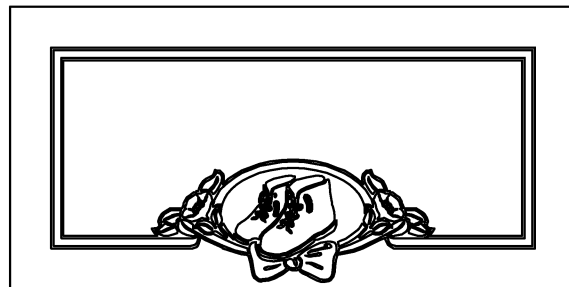

AG-M-20

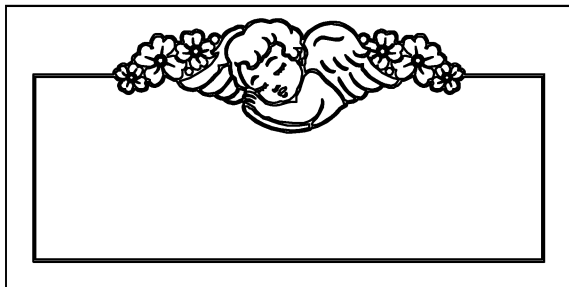

AG-M-21

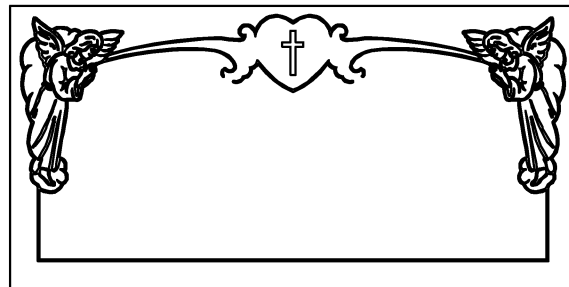

AG-M-22

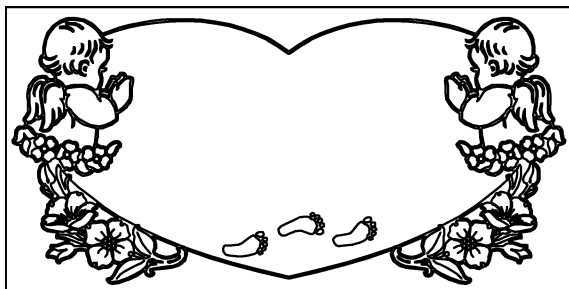

AG-M-23

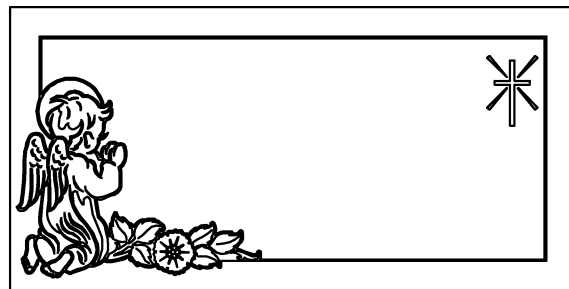

AG-M-24

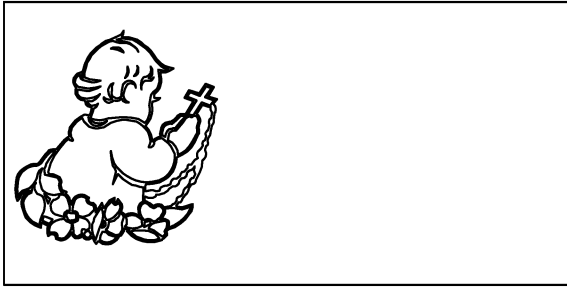

AG-M-25

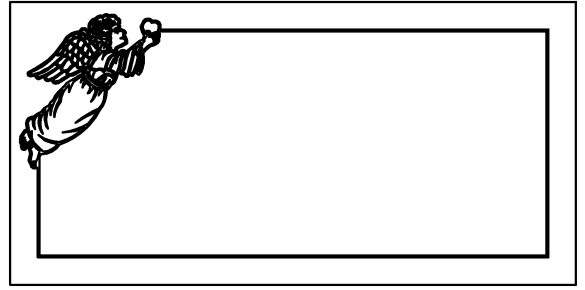

AG-M-26

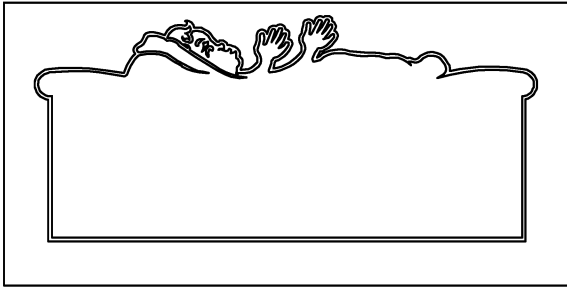

AG-M-27

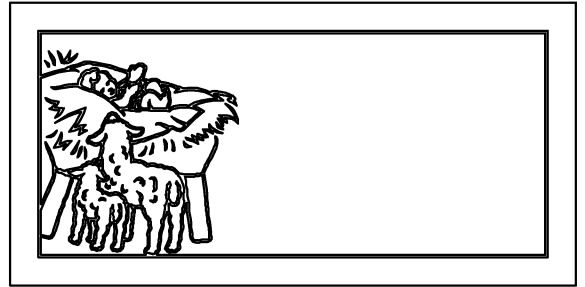

AG-M-28

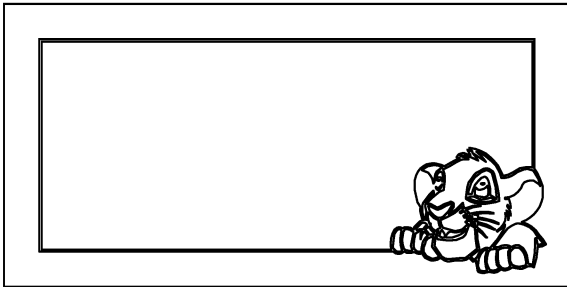

AG-M-29

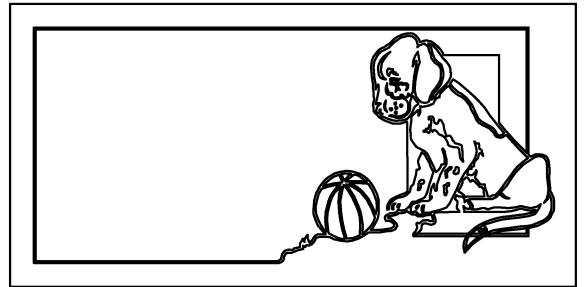

AG-M-30

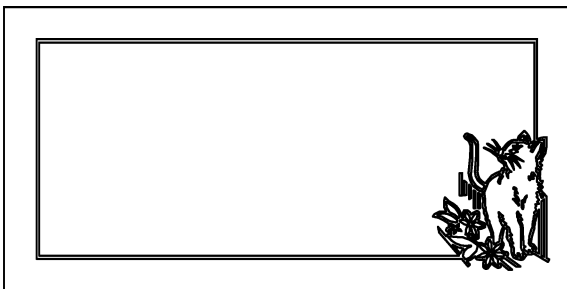

AG-M-31

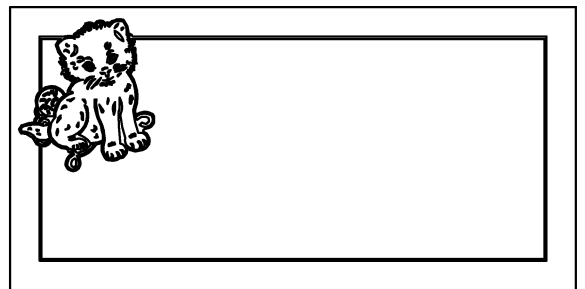

AG-M-32

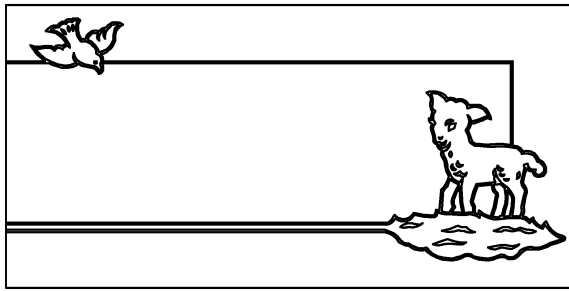

AG-M-33

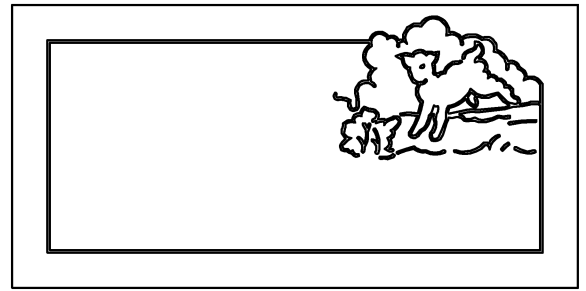

AG-M-34

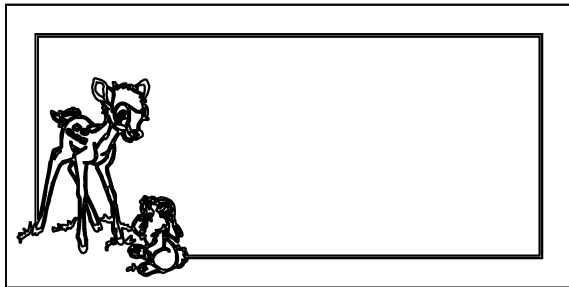

AG-M-35

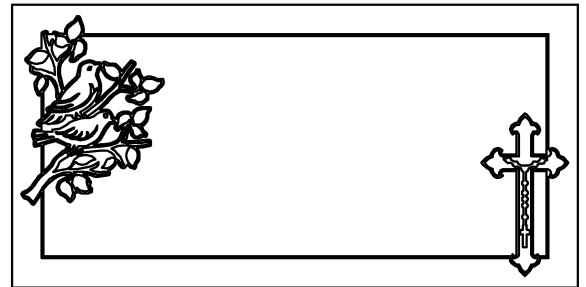

AG-M-36

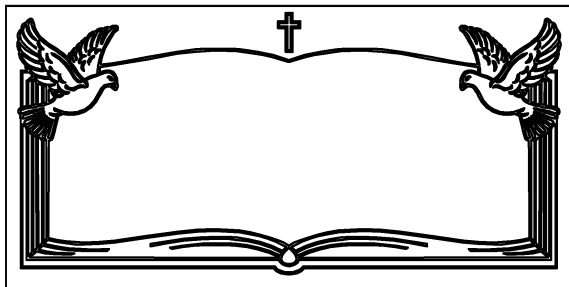

AG-M-37

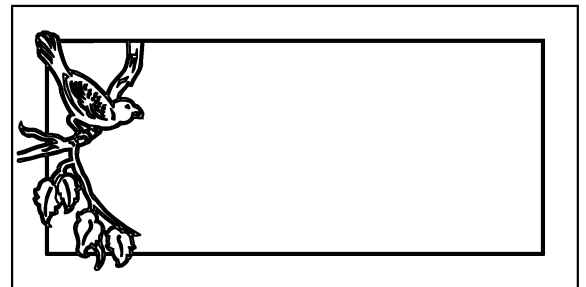

AG-M-38

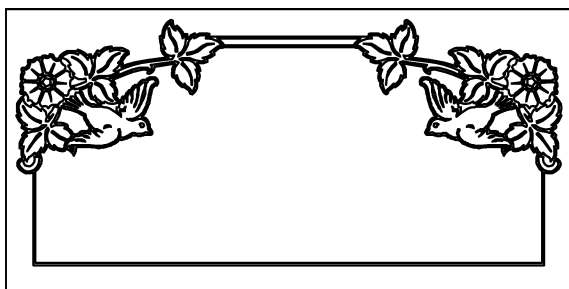

AG-M-39

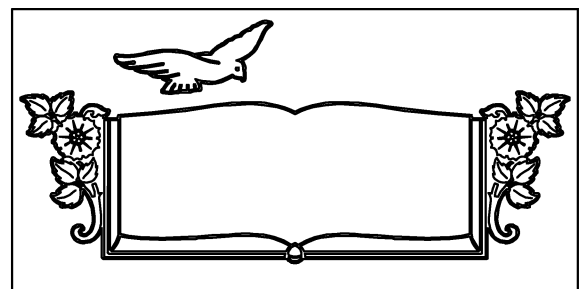

AG-M-40

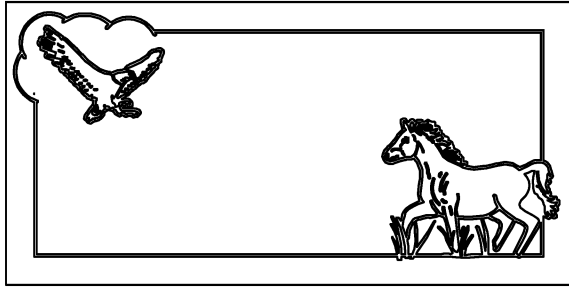

AG-M-41

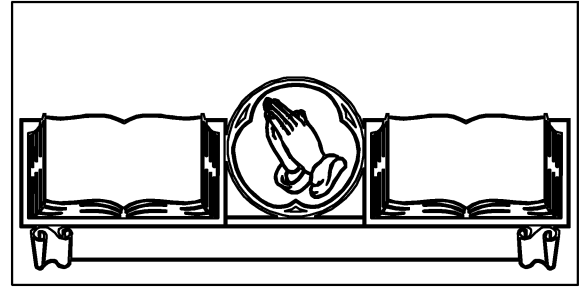

AG-M-42

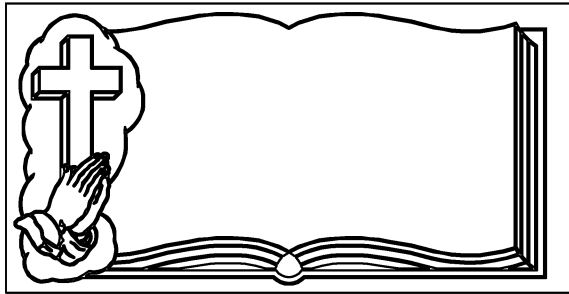

AG-M-43

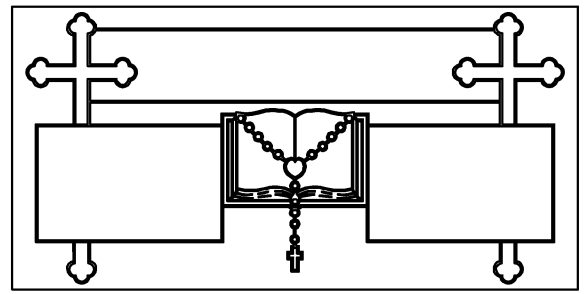

AG-M-44

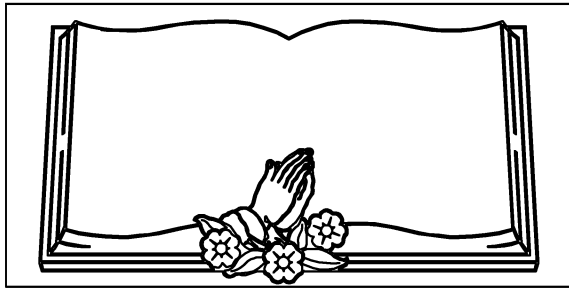

AG-M-45

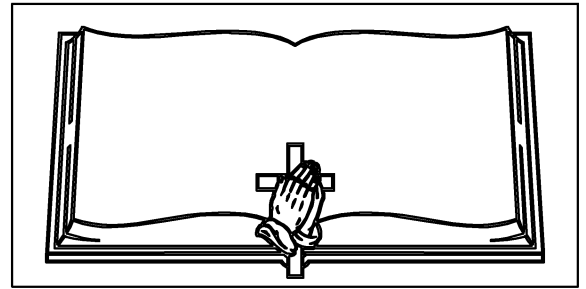

AG-M-46

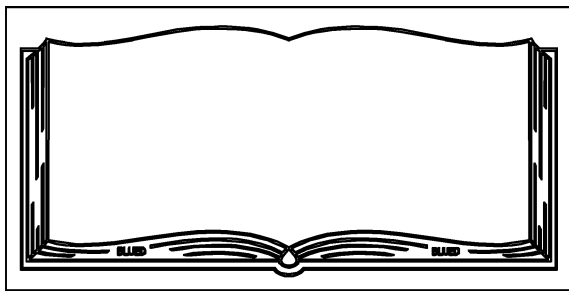

AG-M-47

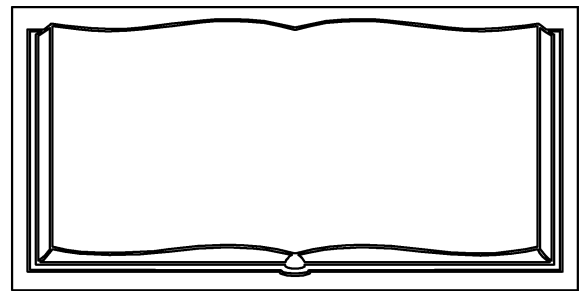

AG-M-48

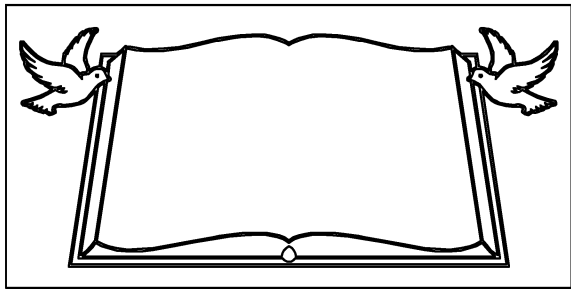

AG-M-49

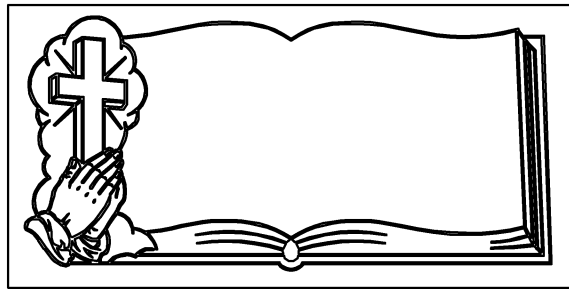

AG-M-50

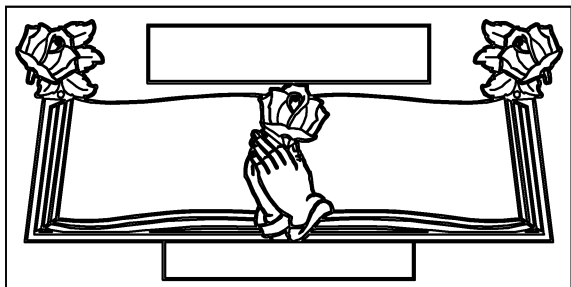

AG-M-51

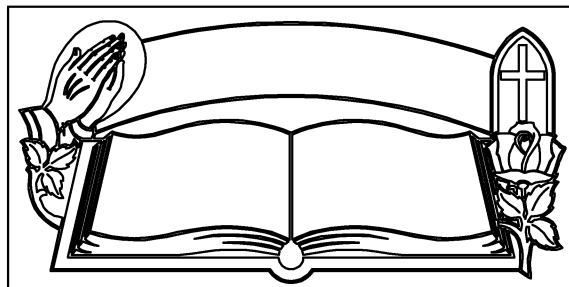

AG-M-52

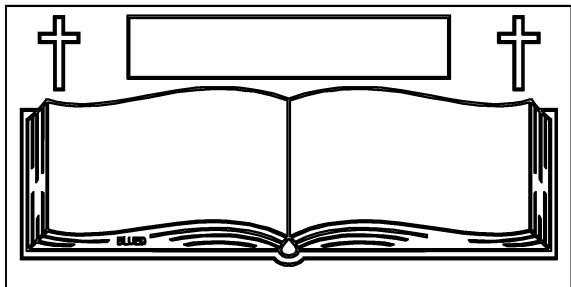

AG-M-53

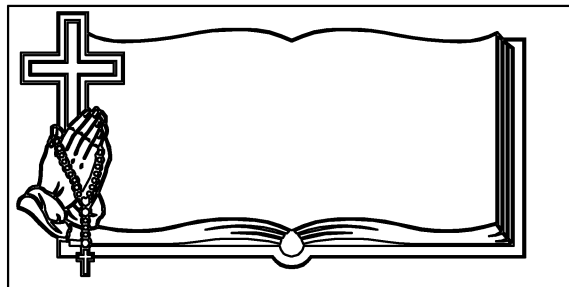

AG-M-54

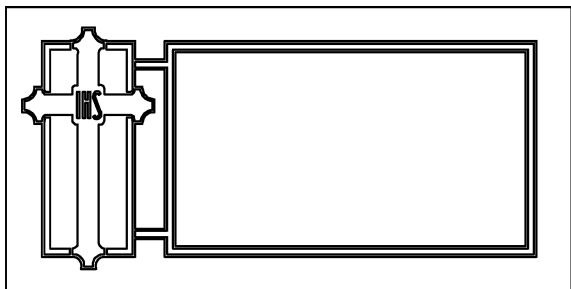

AG-M-55

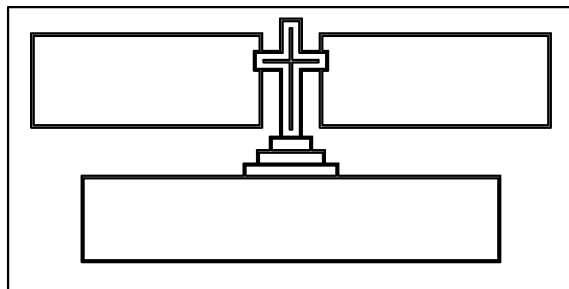

AG-M-56

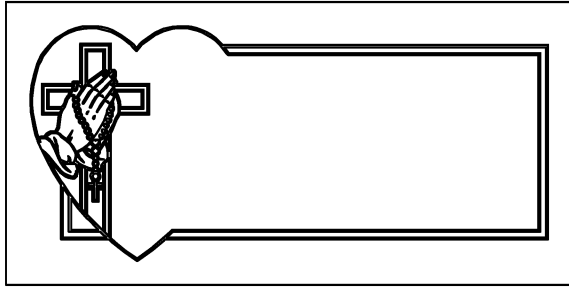

AG-M-57

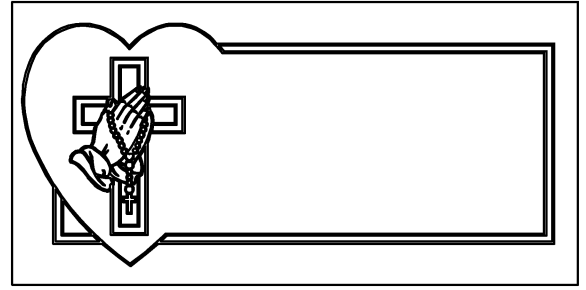

AG-M-58

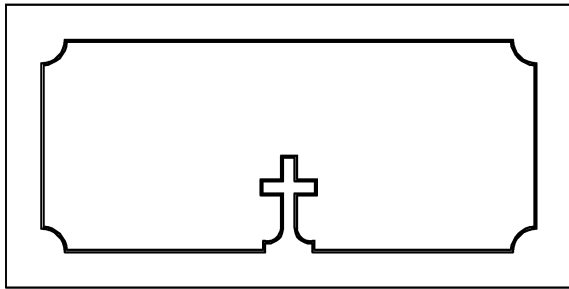

AG-M-59

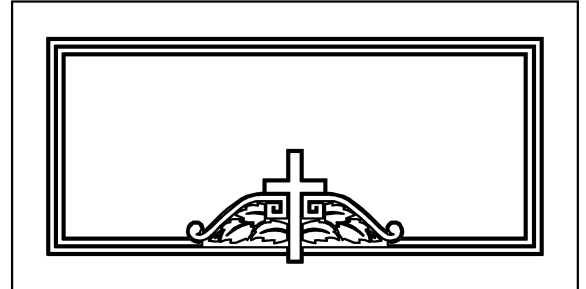

AG-M-60

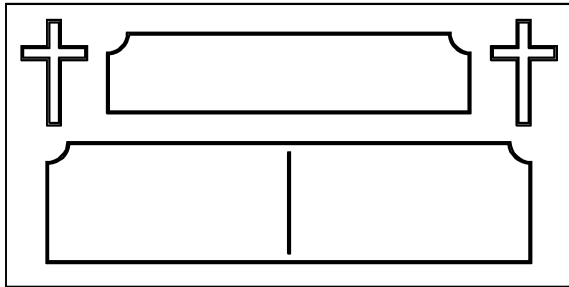

AG-M-61

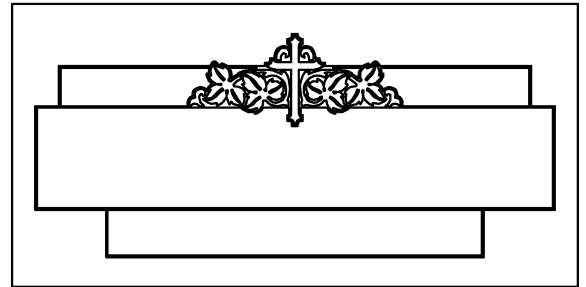

AG-M-62

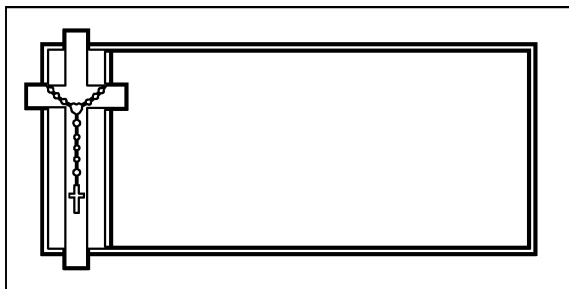

AG-M-63

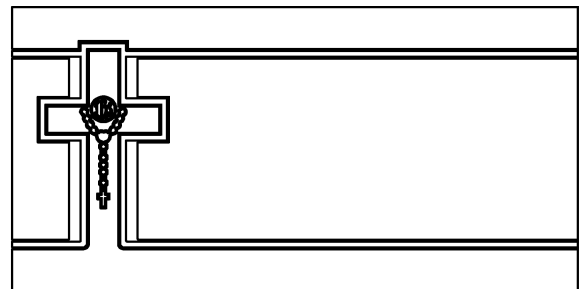

AG-M-64

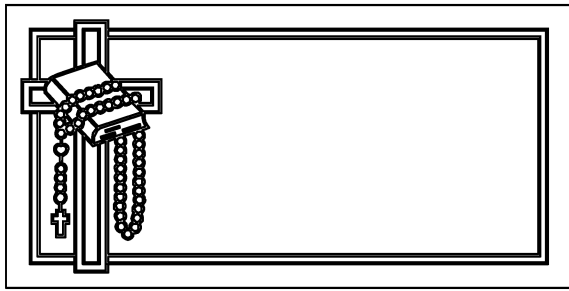

AG-M-65

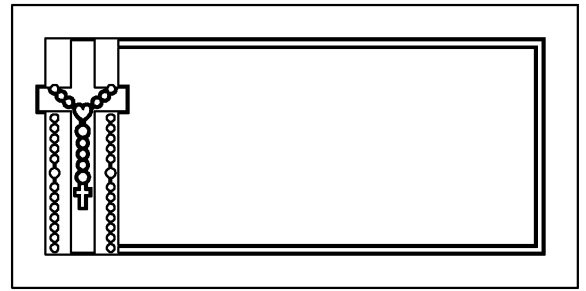

AG-M-66

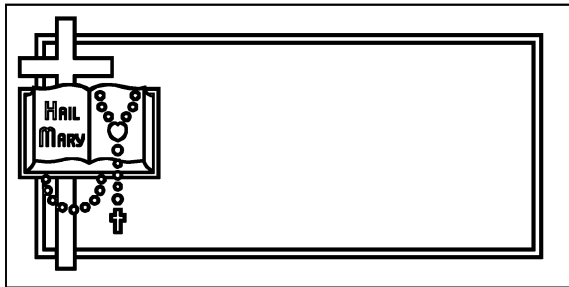

AG-M-67

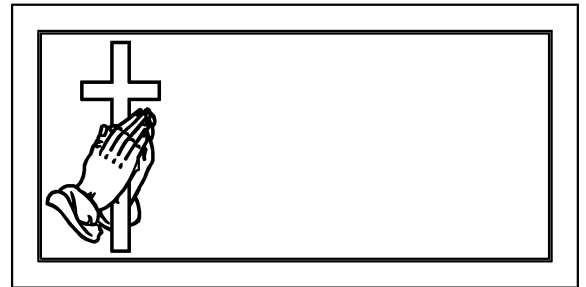

AG-M-68

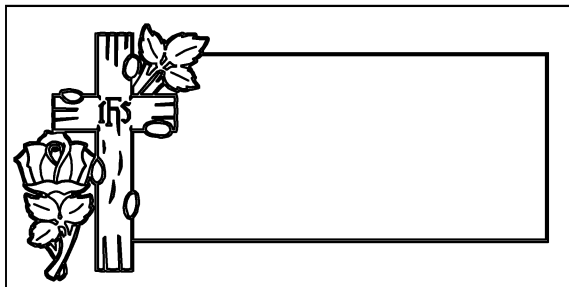

AG-M-69

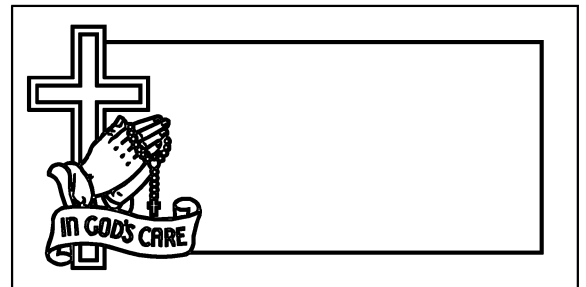

AG-M-70

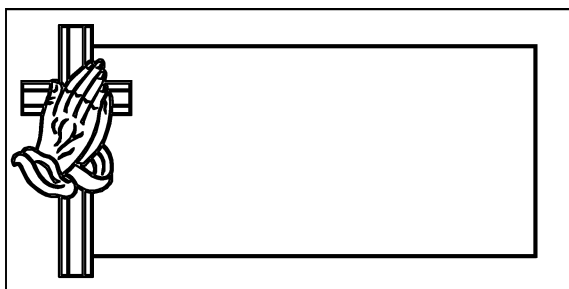

AG-M-71

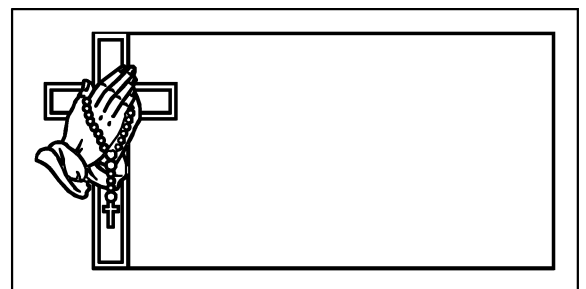

AG-M-72

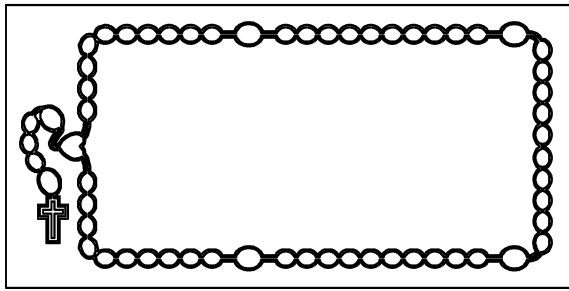

AG-M-73

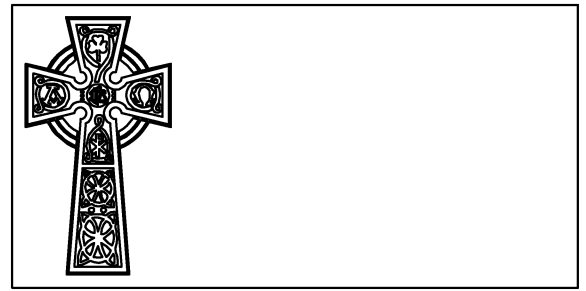

AG-M-74

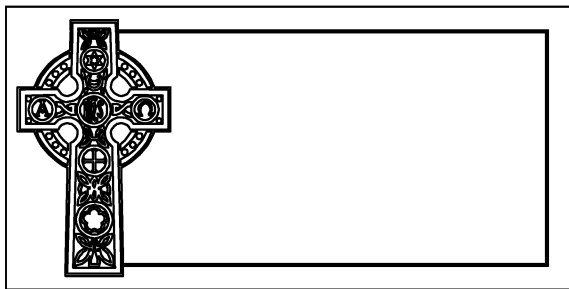

AG-M-75

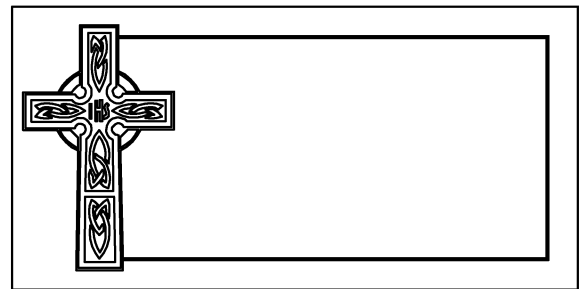

AG-M-76

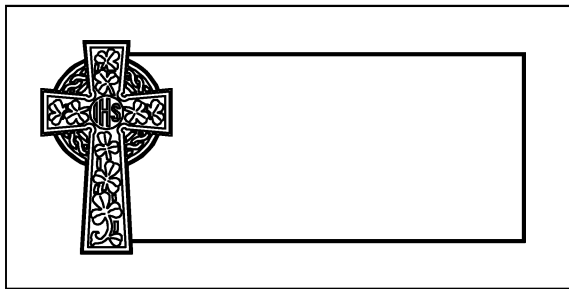

AG-M-77

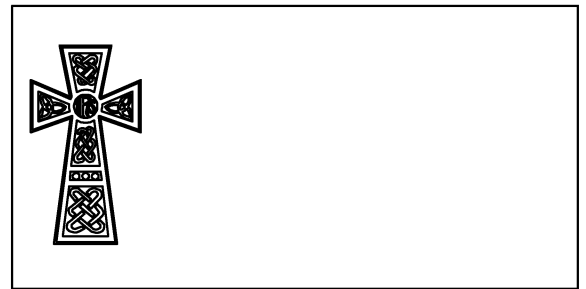

AG-M-78

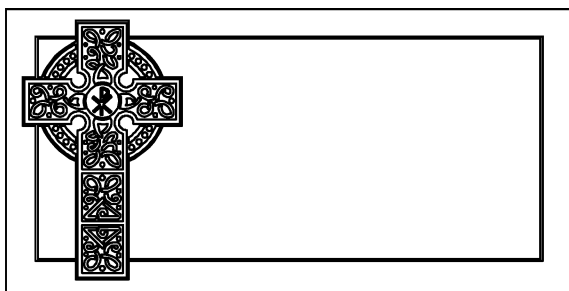

AG-M-79

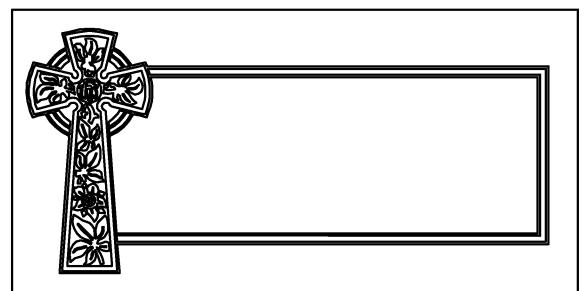

AG-M-80

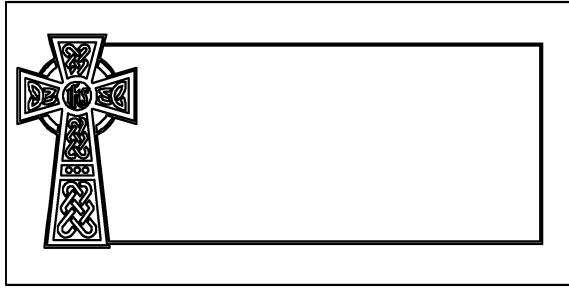

AG-M-81

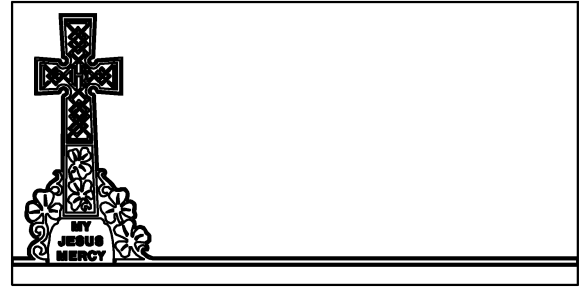

AG-M-82

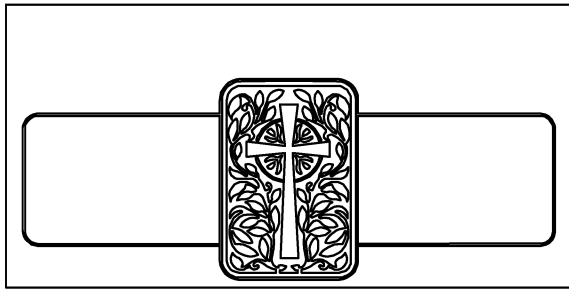

AG-M-83

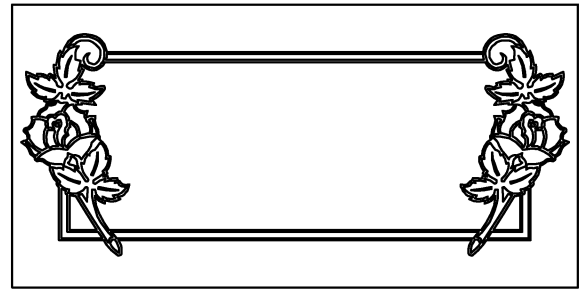

AG-M-84

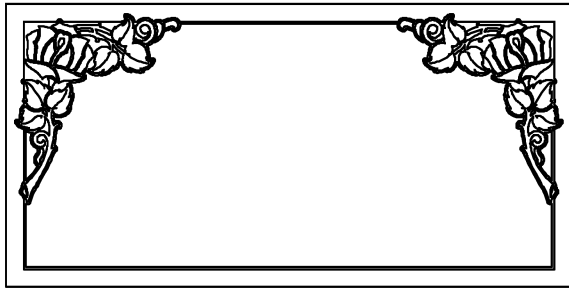

AG-M-85

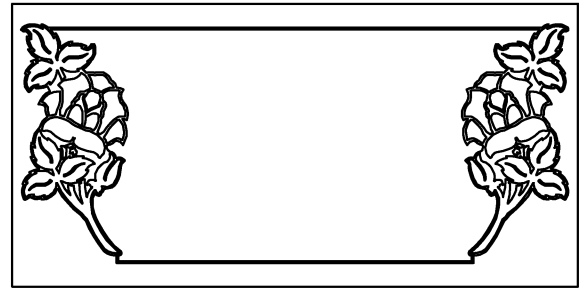

AG-M-86

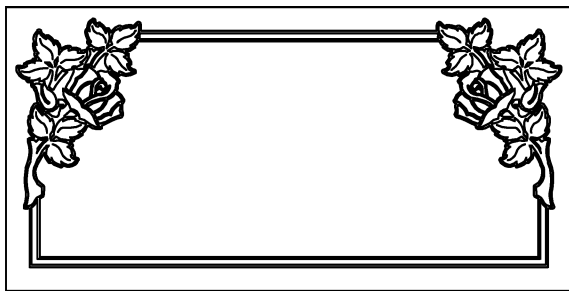

AG-M-87

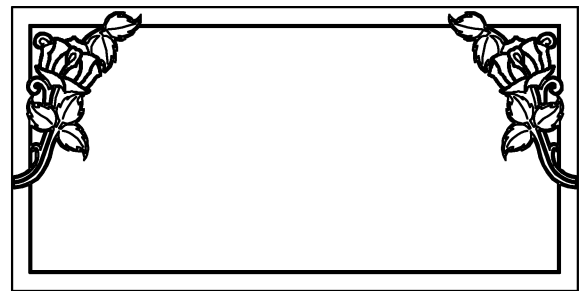

AG-M-88

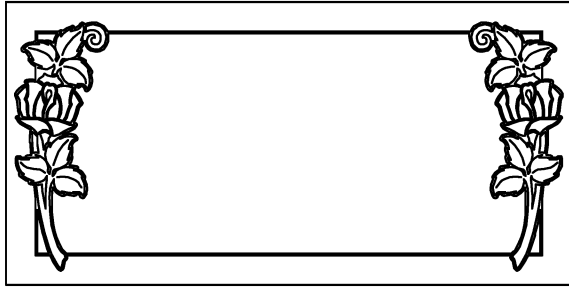

AG-M-89

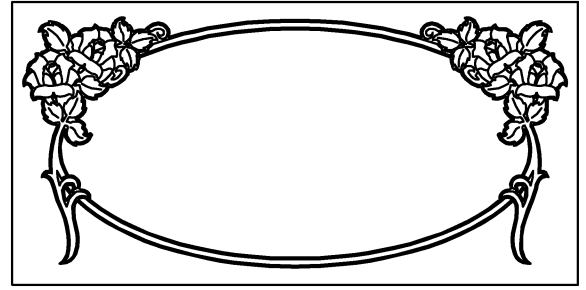

AG-M-90

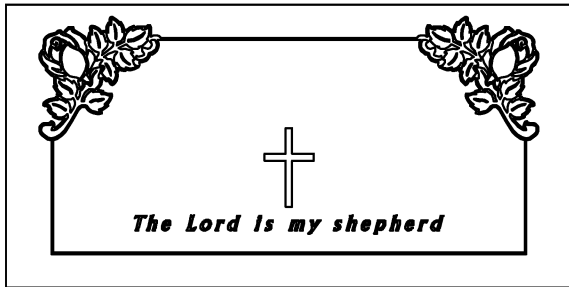

AG-M-91

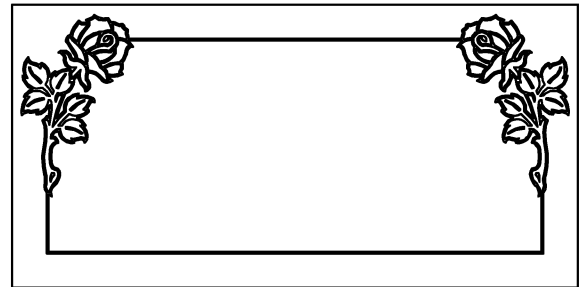

AG-M-92

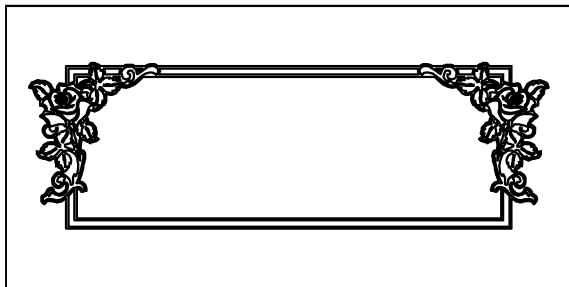

AG-M-93

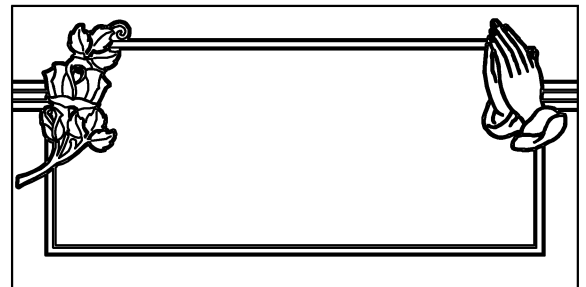

AG-M-94

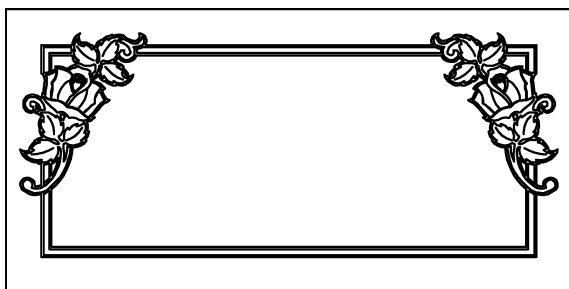

AG-M-95

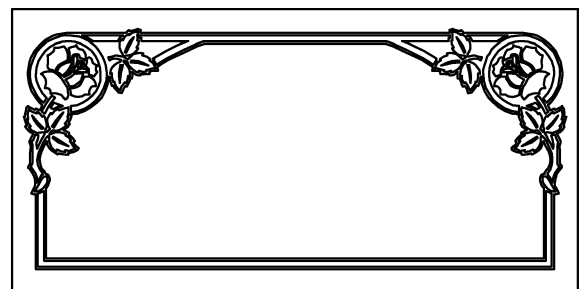

AG-M-96

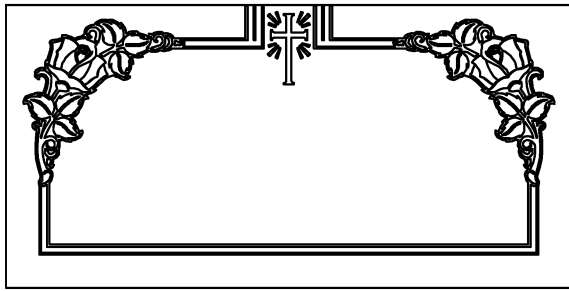

AG-M-97

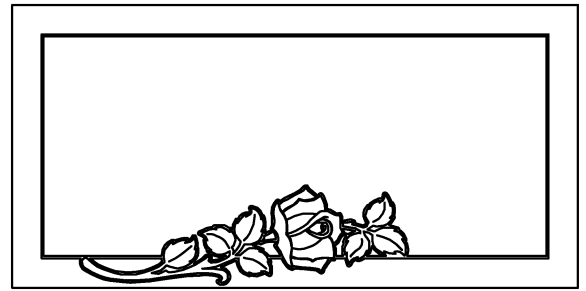

AG-M-98

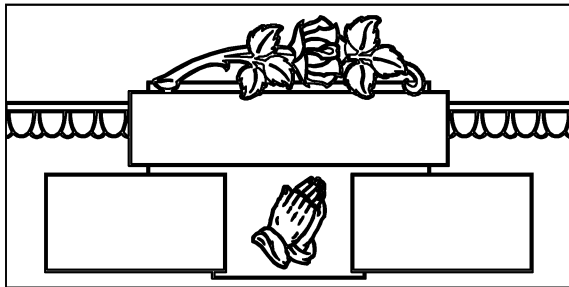

AG-M-99



AG-M-100



AG-M-101

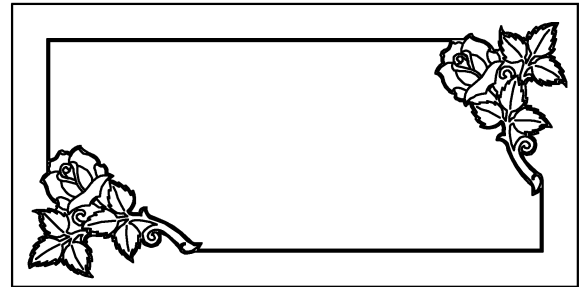

AG-M-102

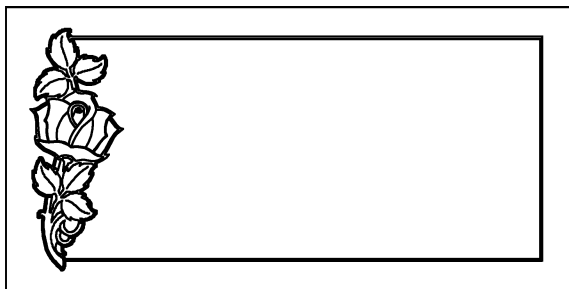

AG-M-103

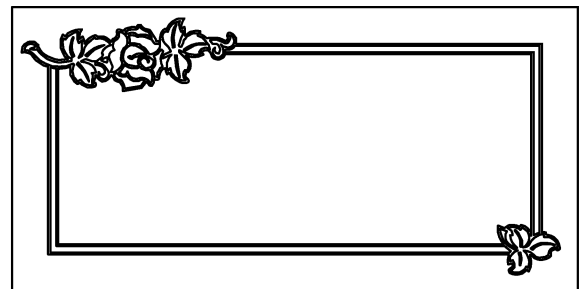

AG-M-104

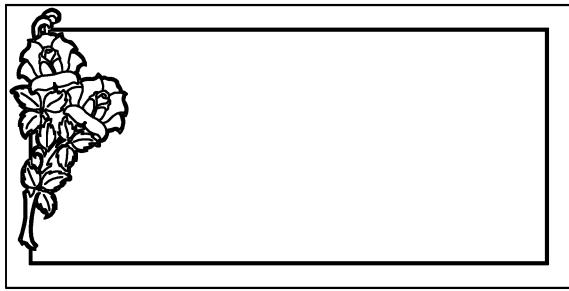

AG-M-105

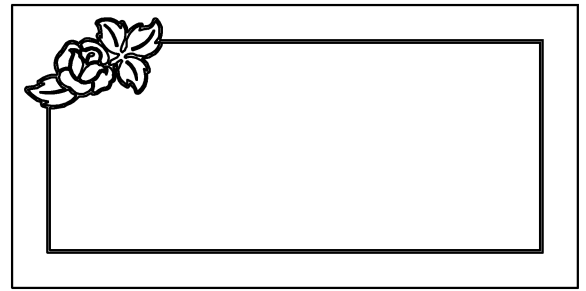

AG-M-106

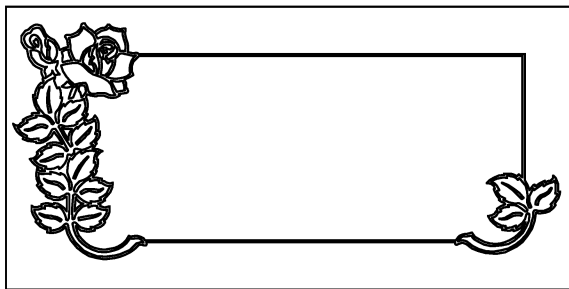

AG-M-107

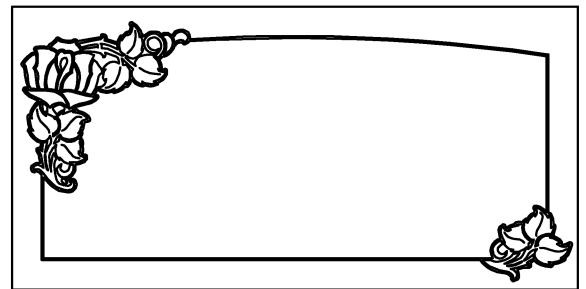

AG-M-108

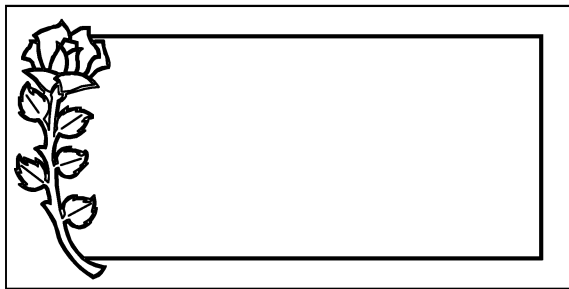

AG-M-109

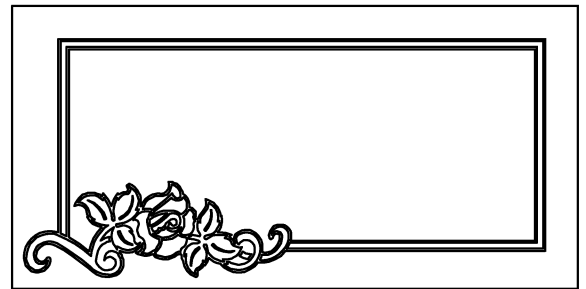

AG-M-110

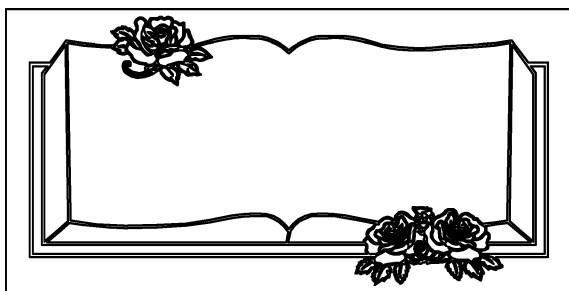

AG-M-111

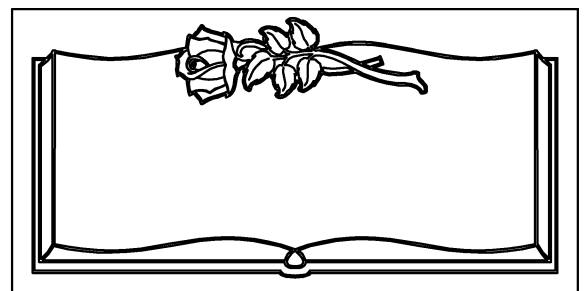

AG-M-112

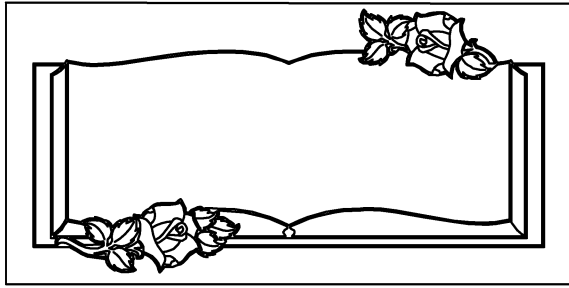

AG-M-113

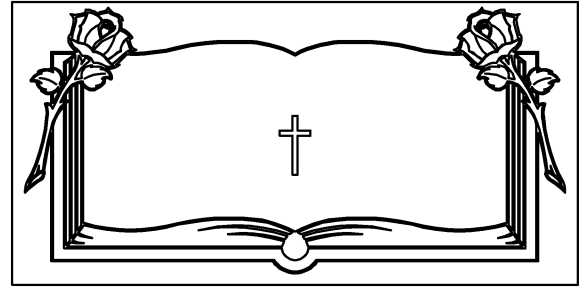

AG-M-114

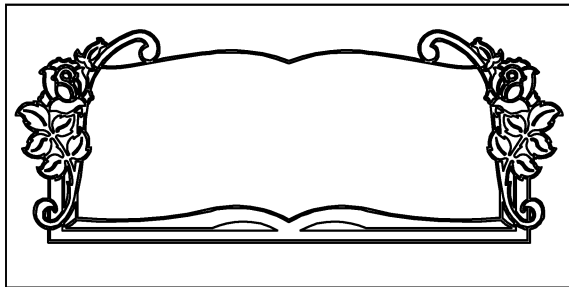

AG-M-115

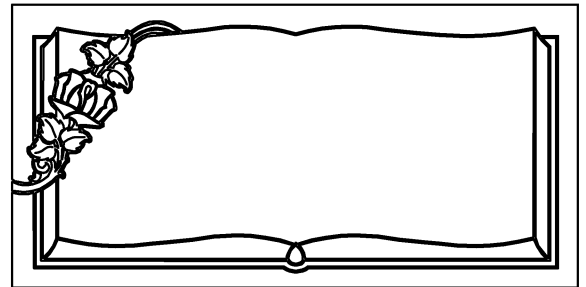

AG-M-116

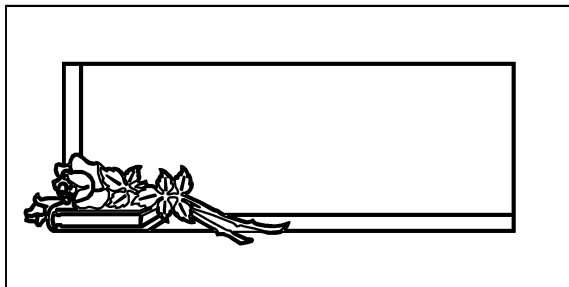

AG-M-117

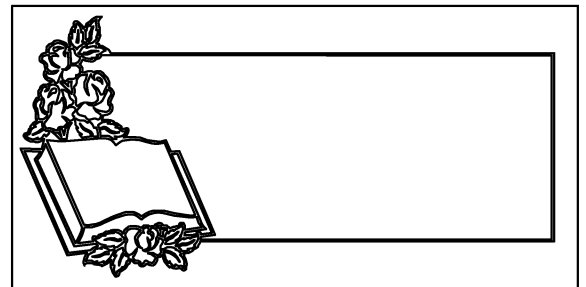

AG-M-118



AG-M-119

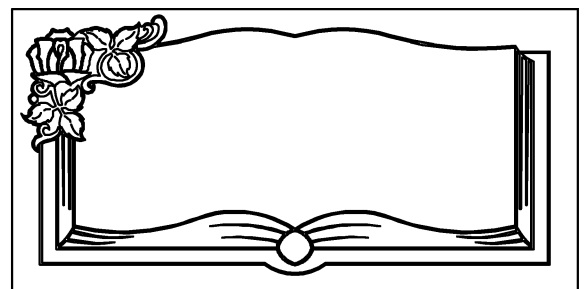

AG-M-120

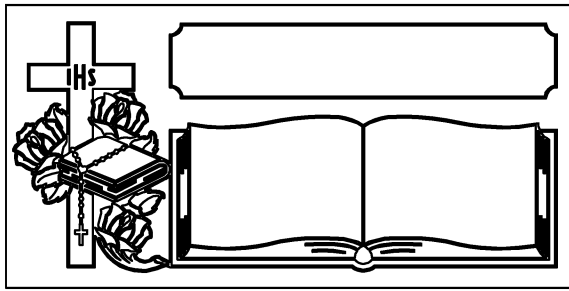

AG-M-121

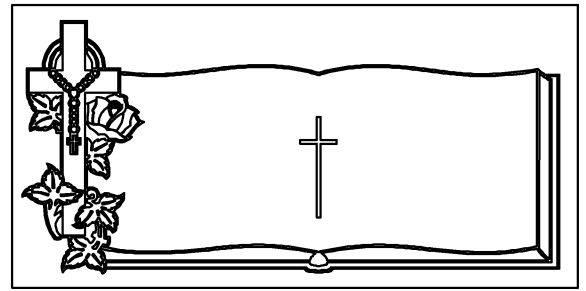

AG-M-122

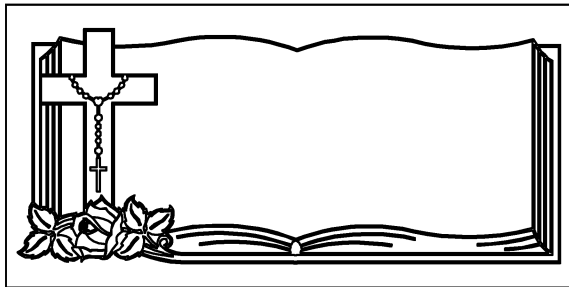

AG-M-123

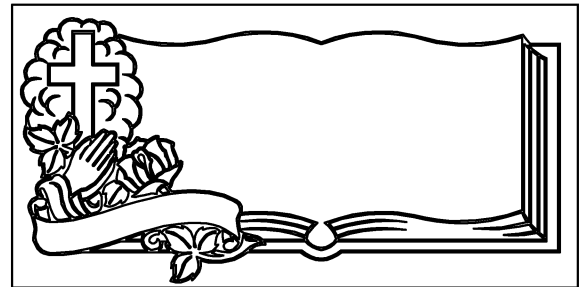

AG-M-124

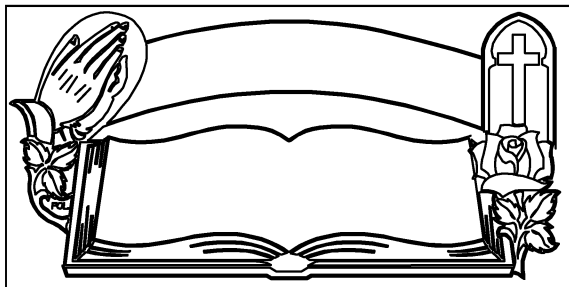

AG-M-125

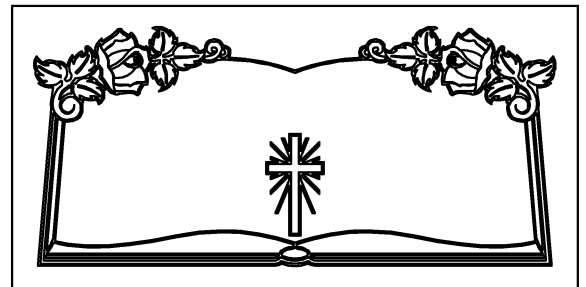

AG-M-126

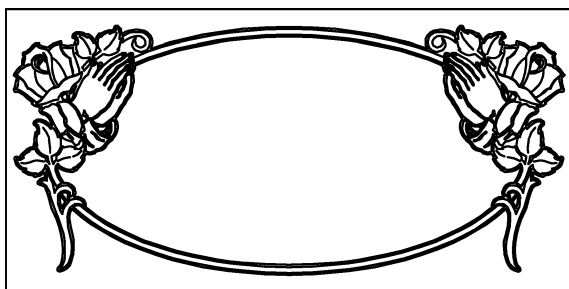

AG-M-127

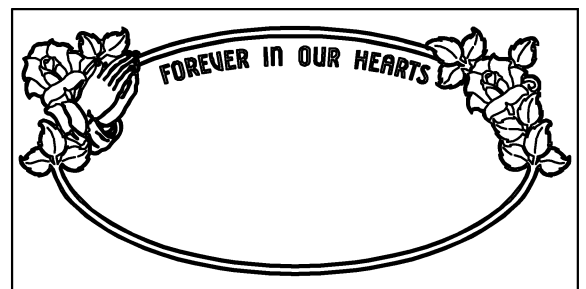

AG-M-128

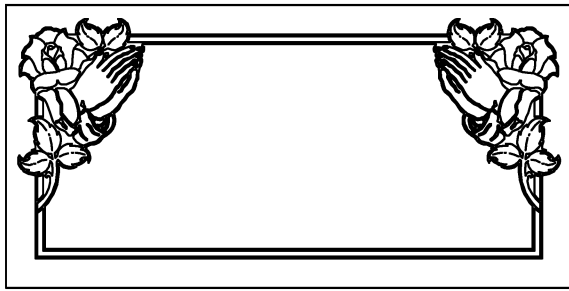

AG-M-129

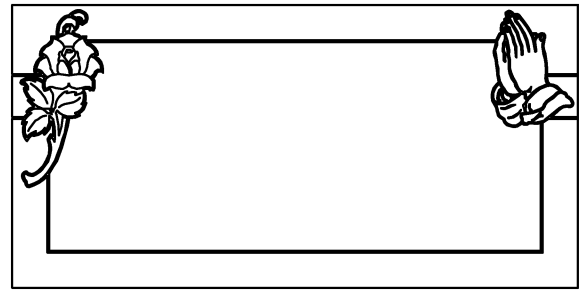

AG-M-130

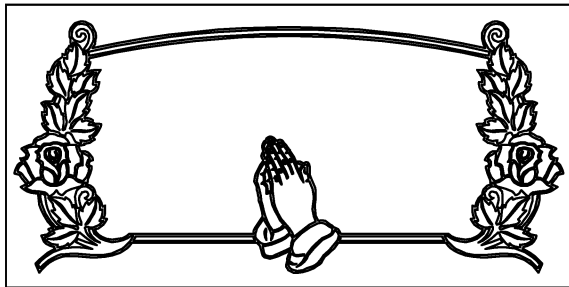

AG-M-131

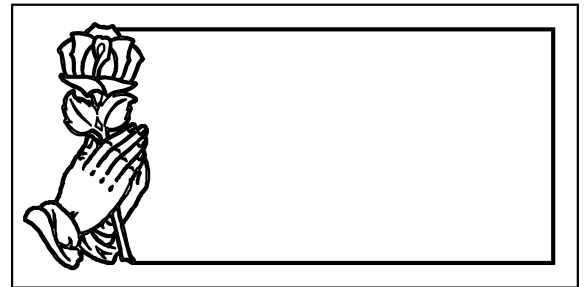

AG-M-132

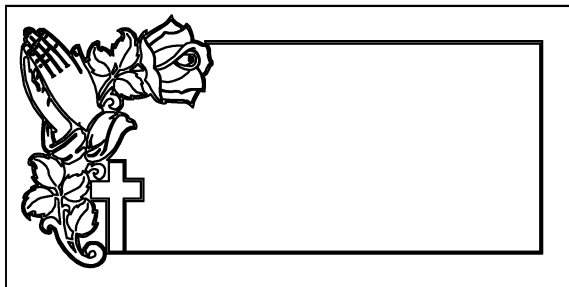

AG-M-133

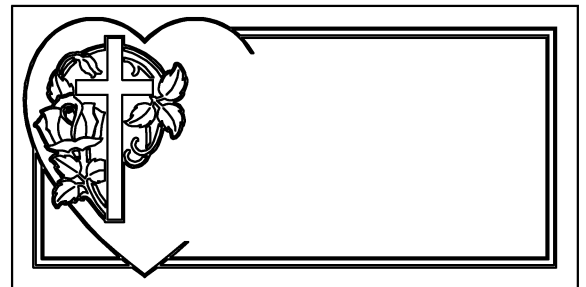

AG-M-134

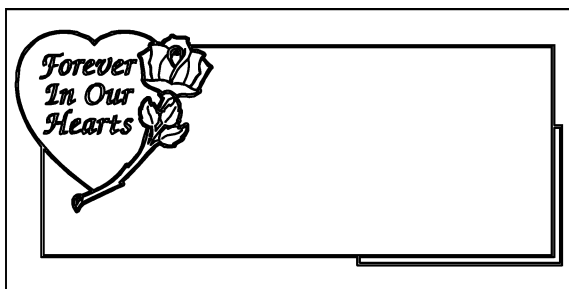

AG-M-135

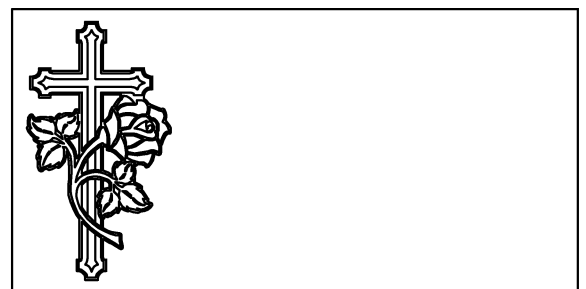

AG-M-136

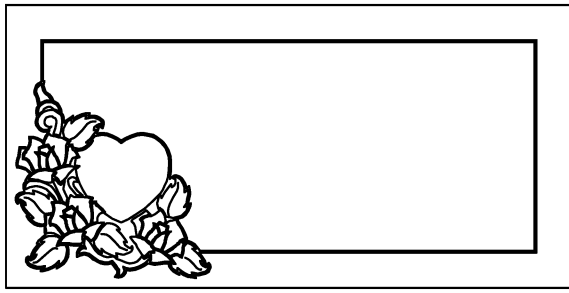

AG-M-137

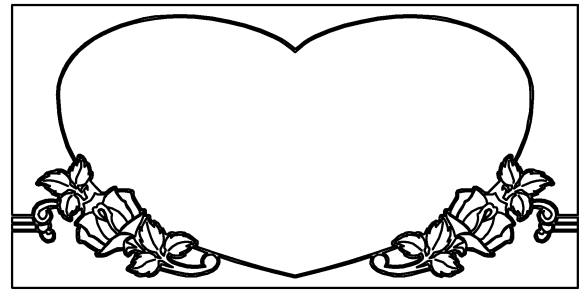

AG-M-138

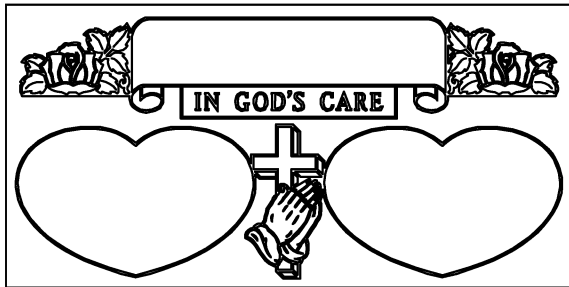

AG-M-139

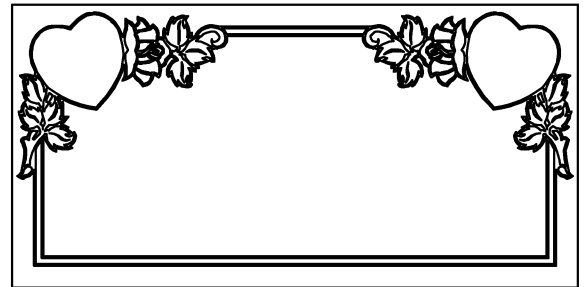

AG-M-140

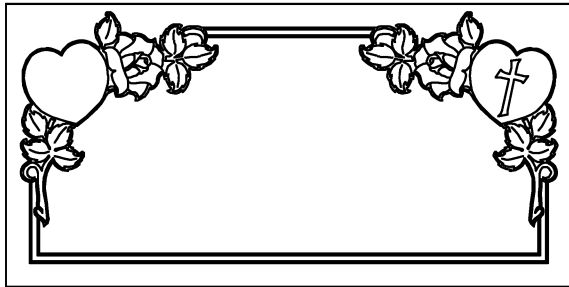

AG-M-141

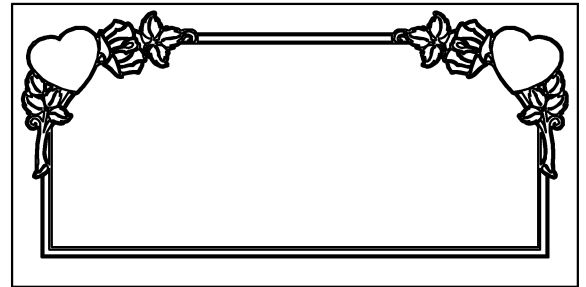

AG-M-142

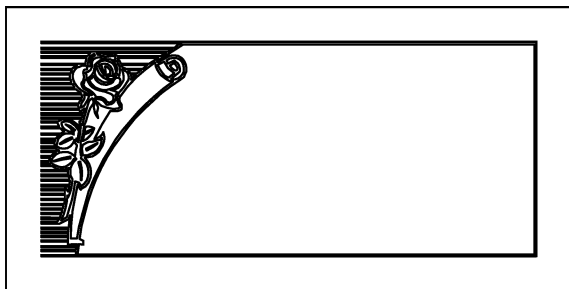

AG-M-143

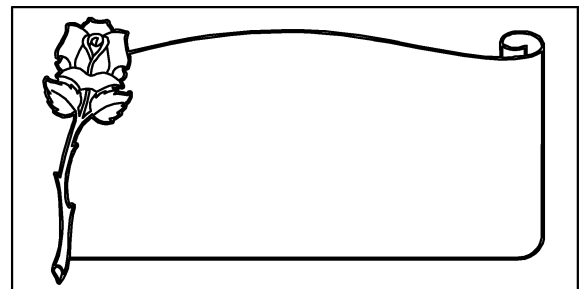

AG-M-144

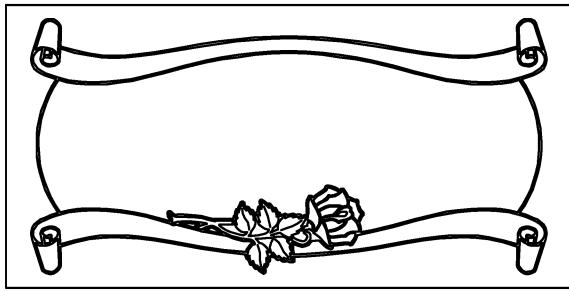

AG-M-145

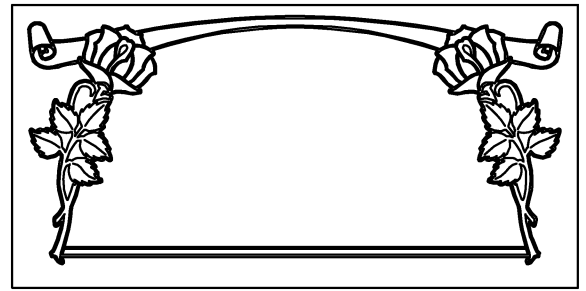

AG-M-146

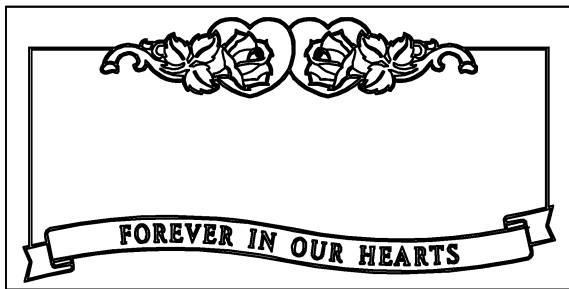

AG-M-147

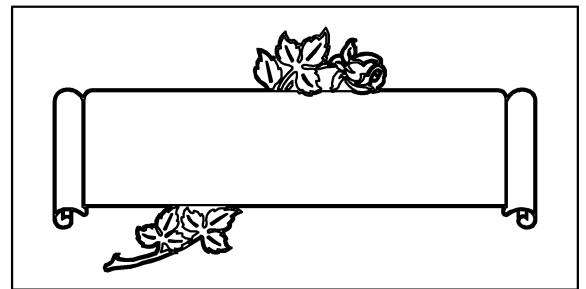

AG-M-148

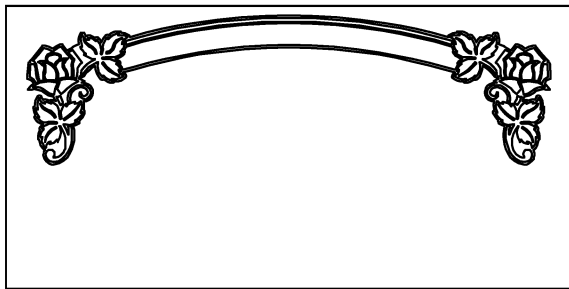

AG-M-149

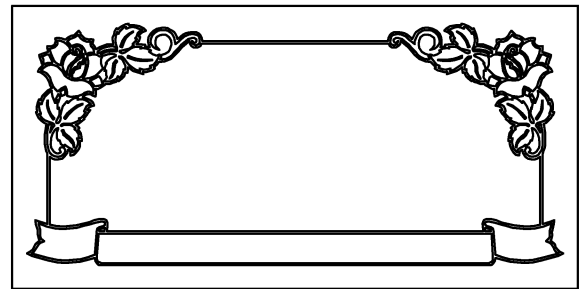

AG-M-150

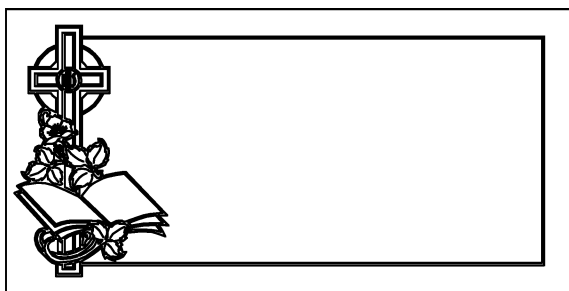

AG-M-151

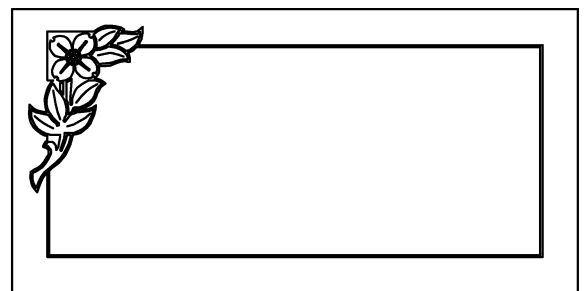

AG-M-152

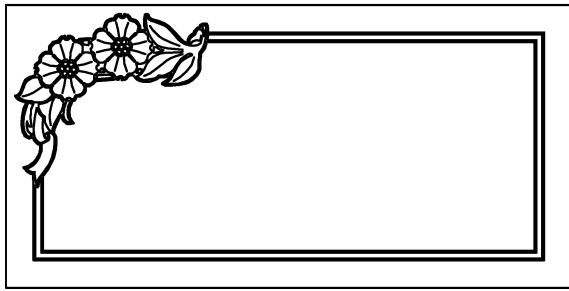

AG-M-153

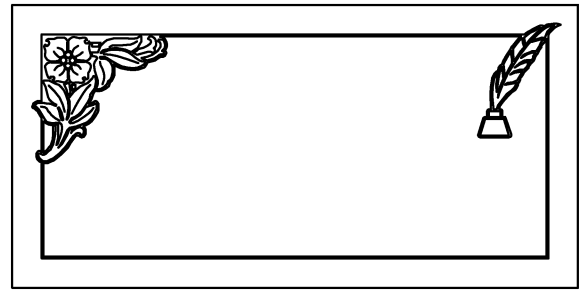

AG-M-154

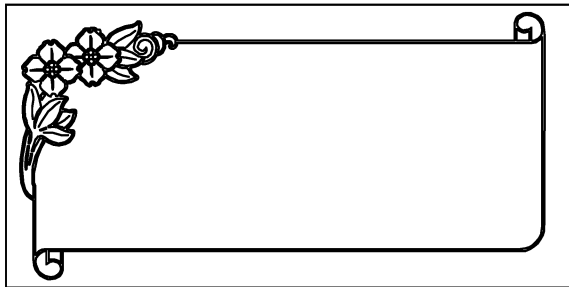

AG-M-155



AG-M-156

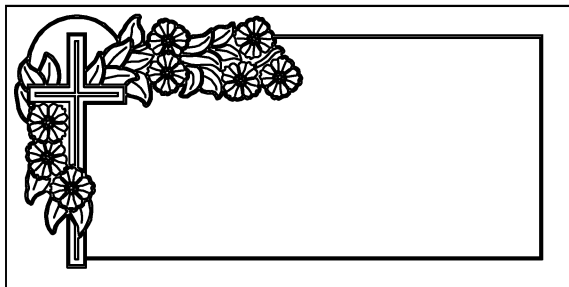

AG-M-157

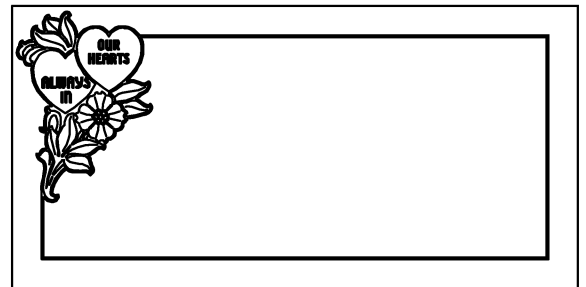

AG-M-158

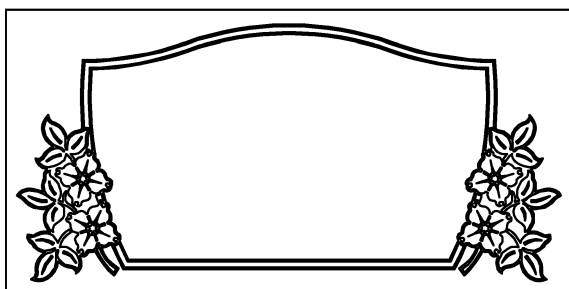

AG-M-159

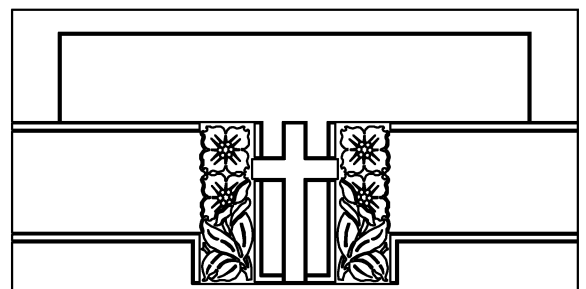

AG-M-160

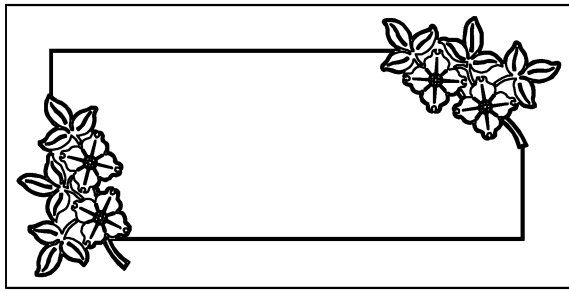

AG-M-161

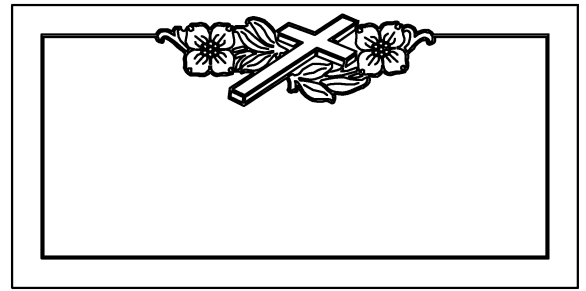

AG-M-162

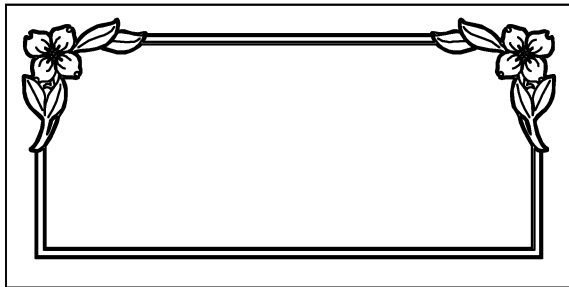

AG-M-163

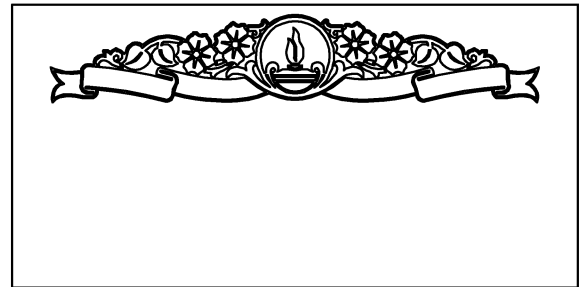

AG-M-164

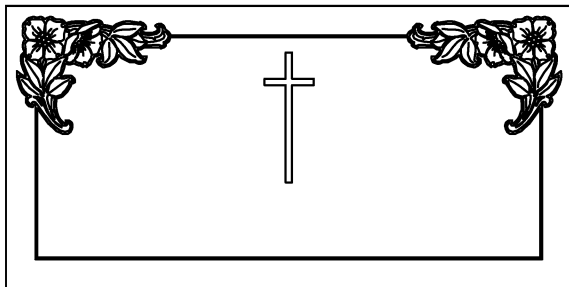

AG-M-165

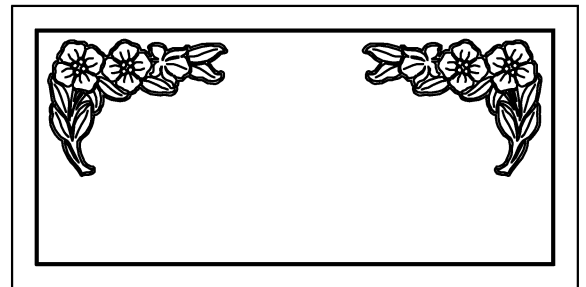

AG-M-166

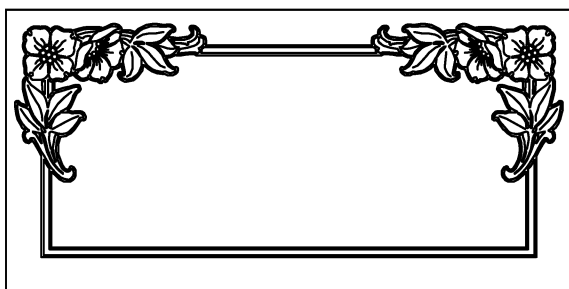

AG-M-167

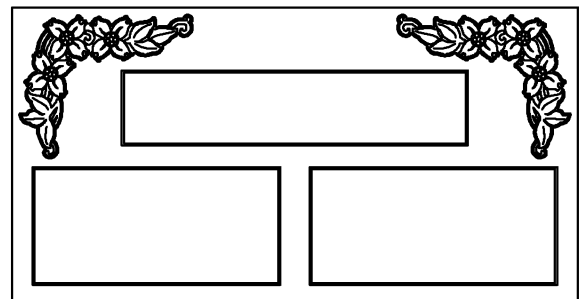

AG-M-168

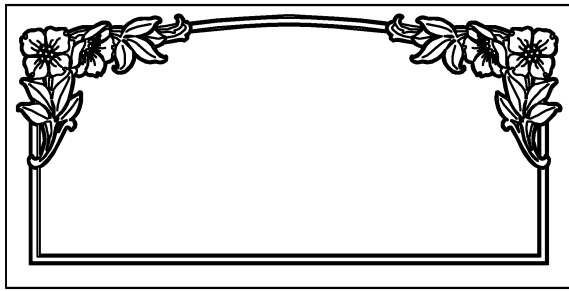

AG-M-169

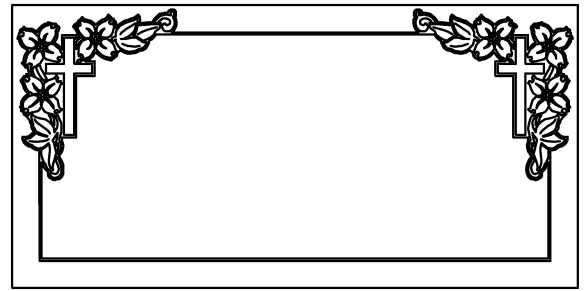

AG-M-170

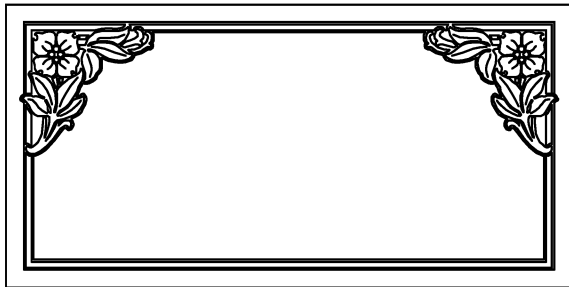

AG-M-171

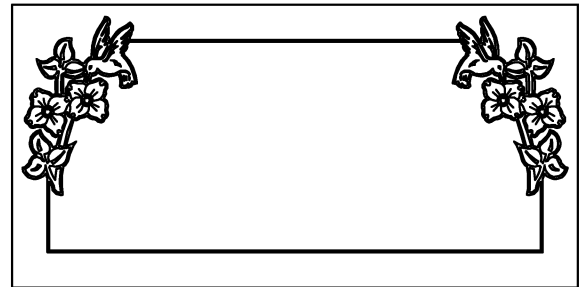

AG-M-172

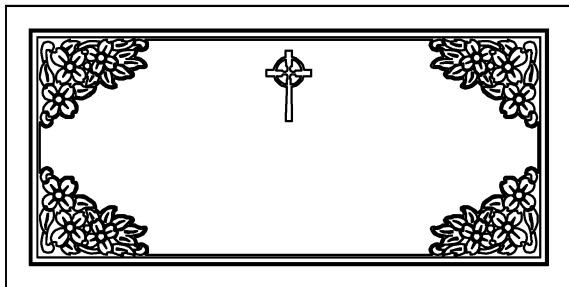

AG-M-173

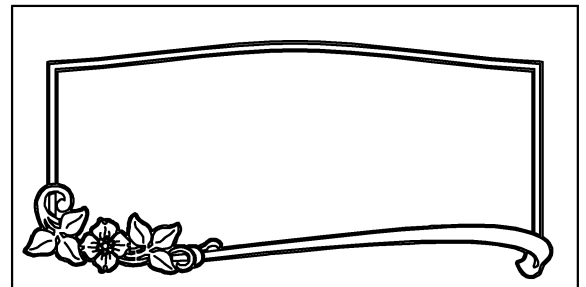

AG-M-174

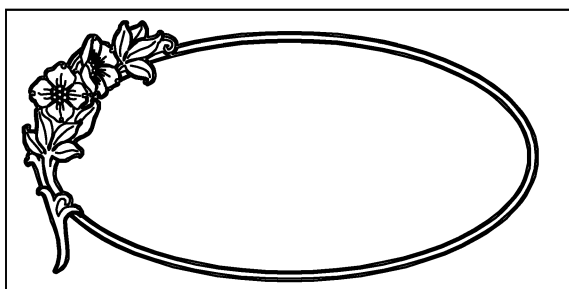

AG-M-175

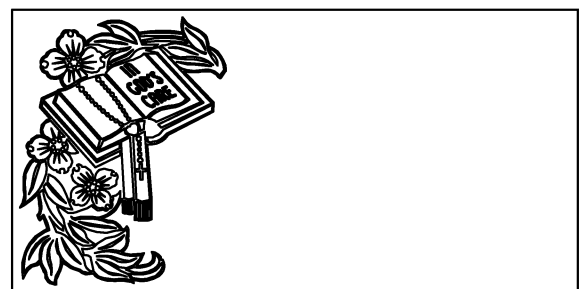

AG-M-176

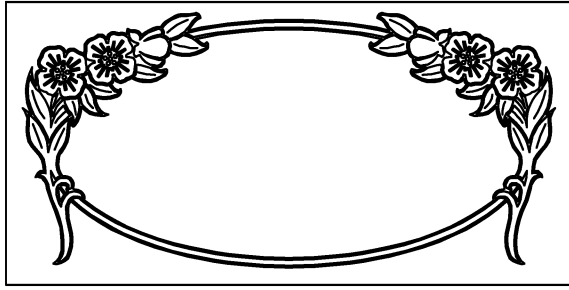

AG-M-177

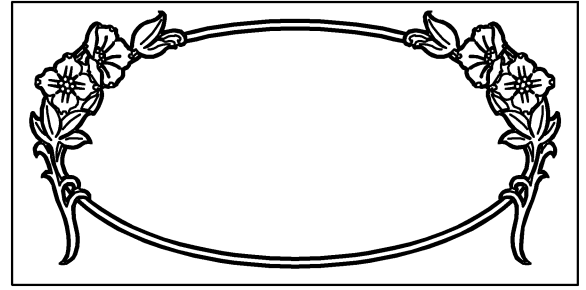

AG-M-178

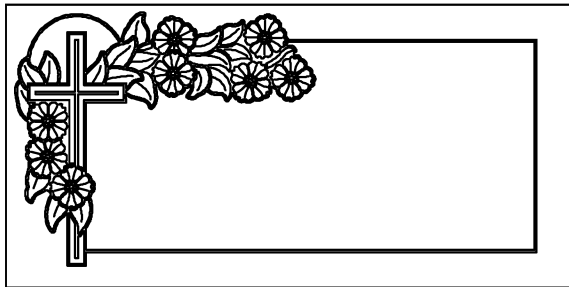

AG-M-179

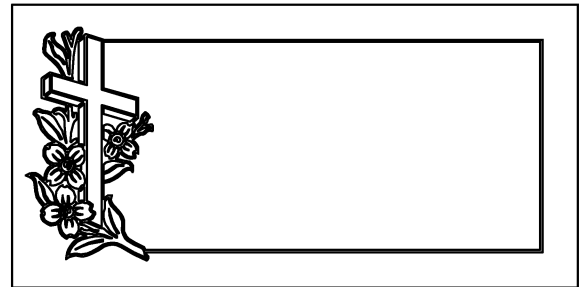

AG-M-180

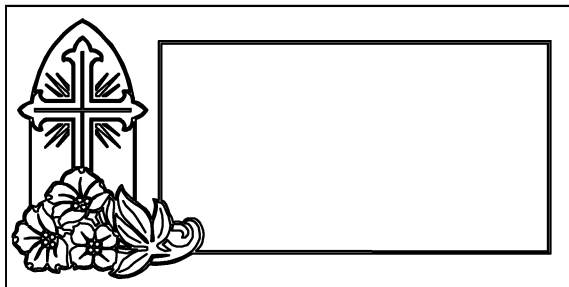

AG-M-181

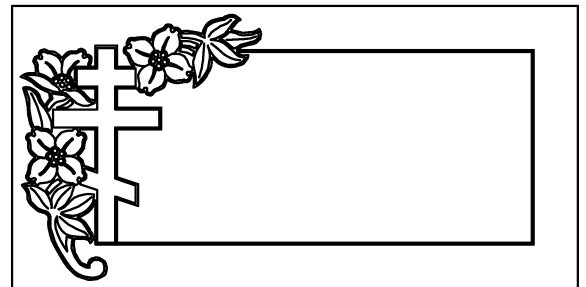

AG-M-182

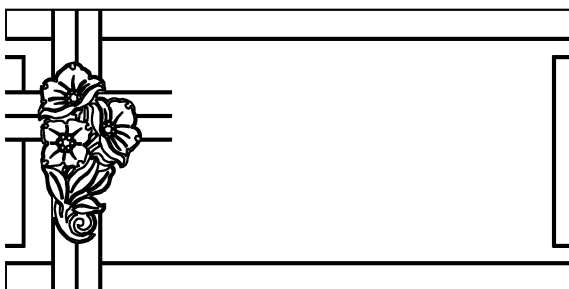

AG-M-183

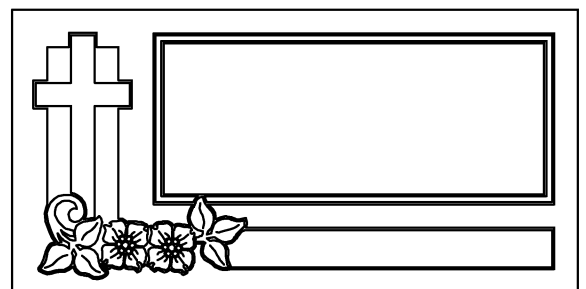

AG-M-184

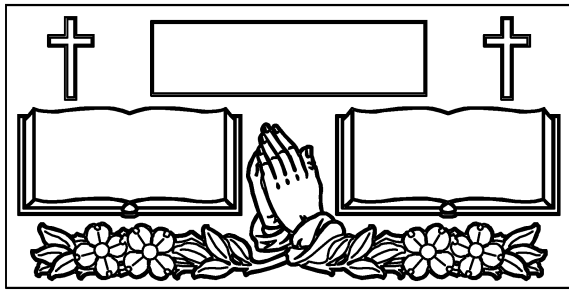

AG-M-185

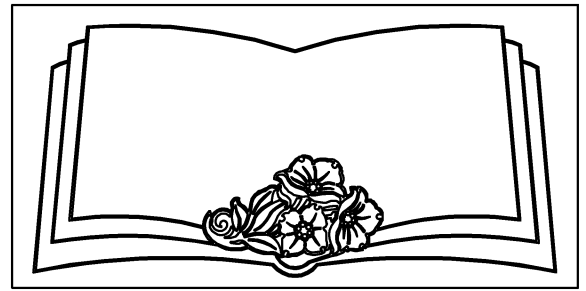

AG-M-186

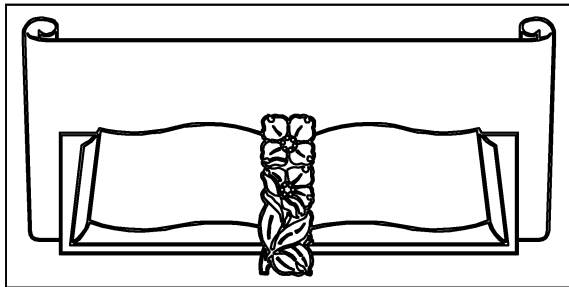

AG-M-187

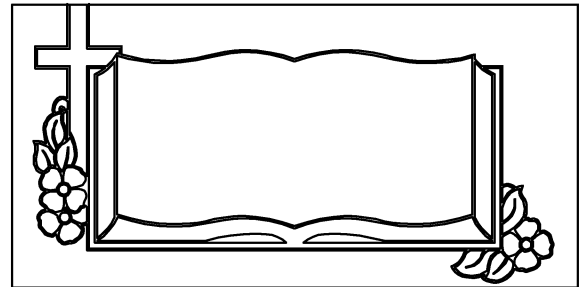

AG-M-188

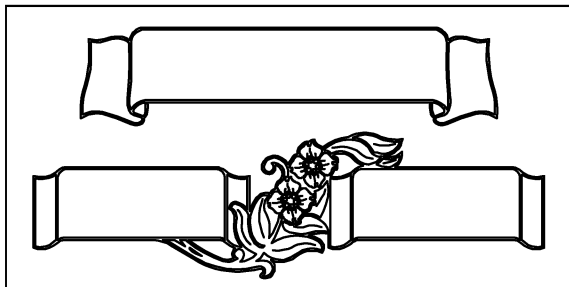

AG-M-189

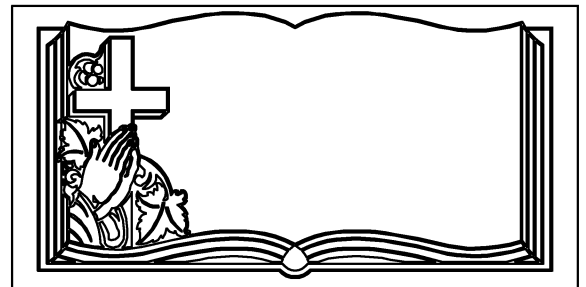

AG-M-190

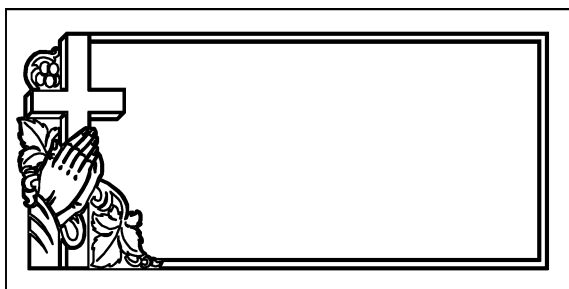

AG-M-191

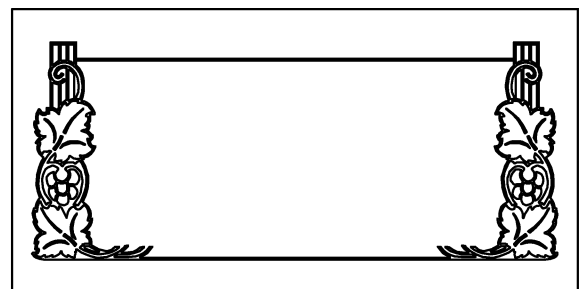

AG-M-192

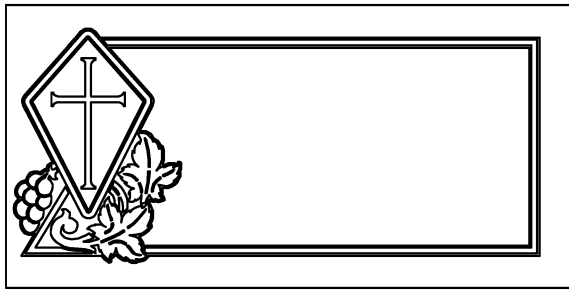

AG-M-193

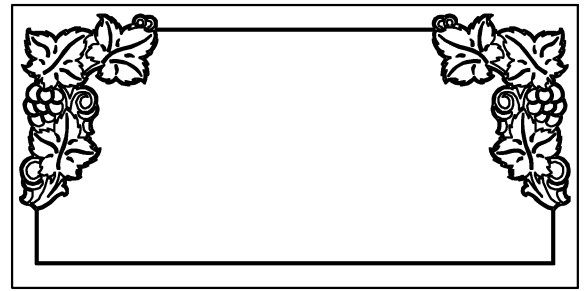

AG-M-194

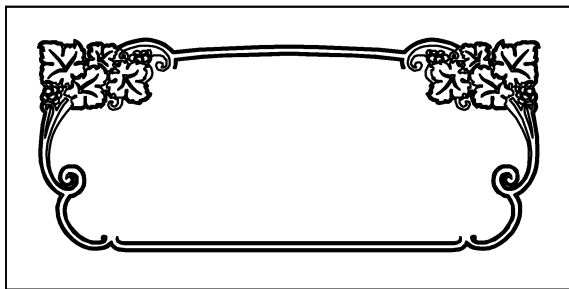

AG-M-195

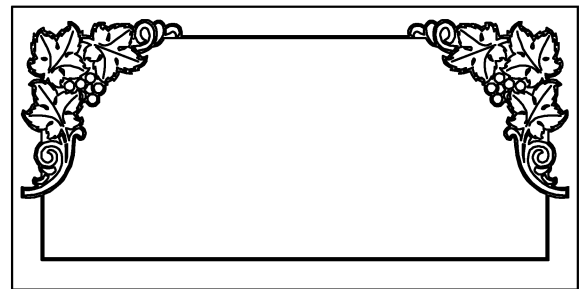

AG-M-196

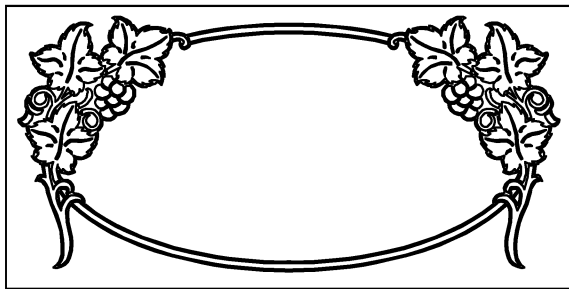

AG-M-197

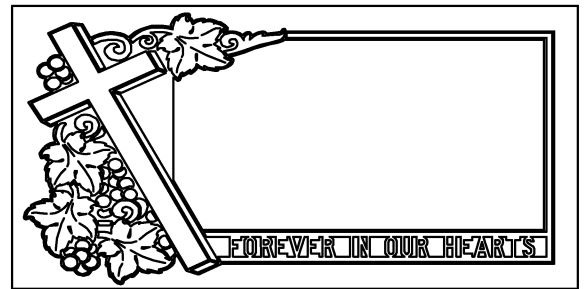

AG-M-198

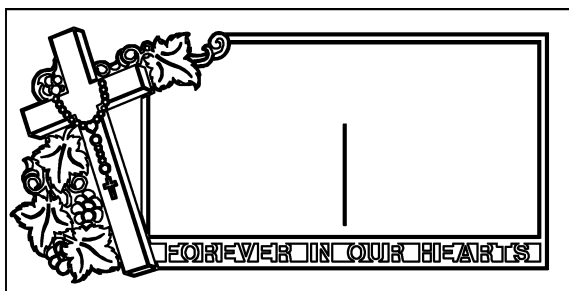

AG-M-199

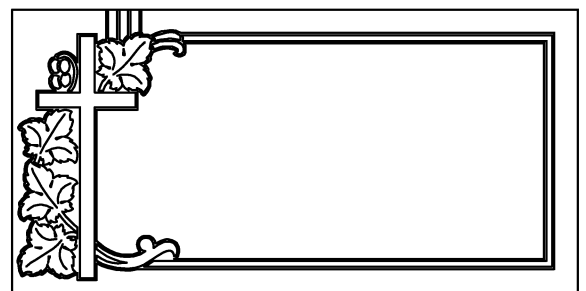

AG-M-200

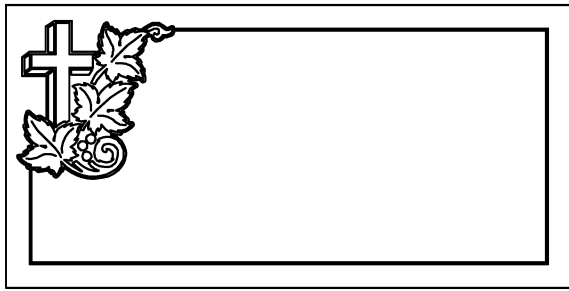

AG-M-201

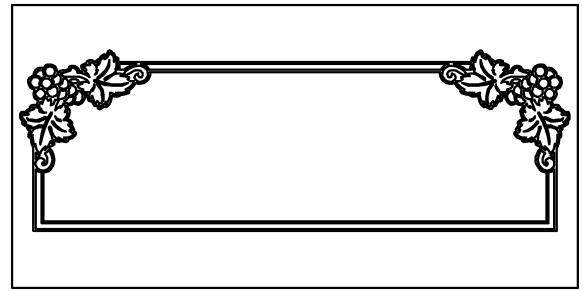

AG-M-202

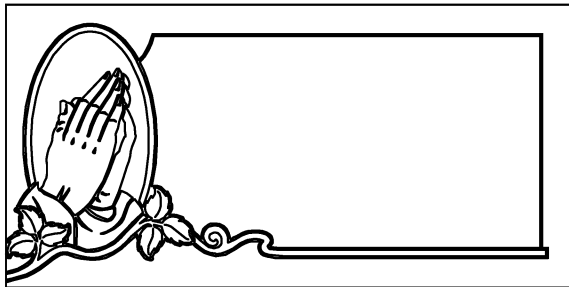

AG-M-203

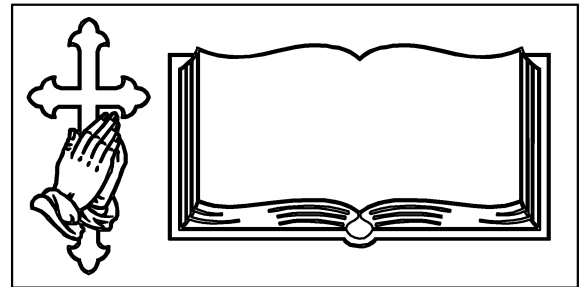

AG-M-204

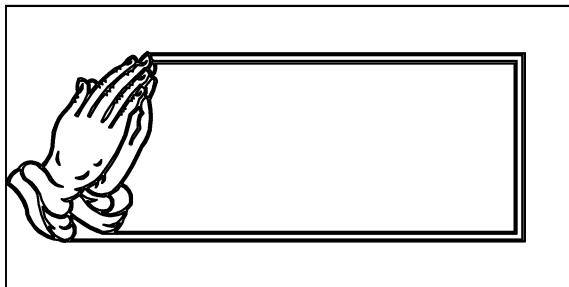

AG-M-205

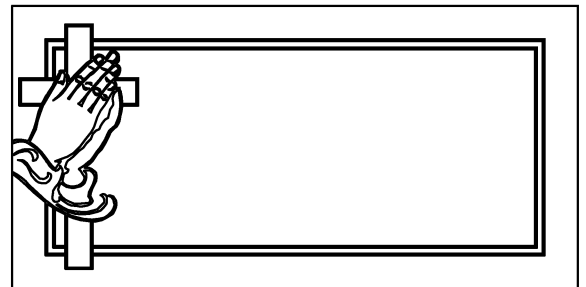

AG-M-206

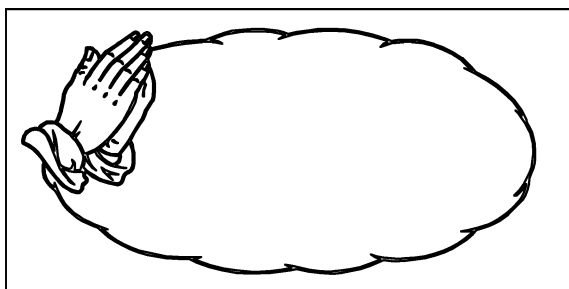

AG-M-207

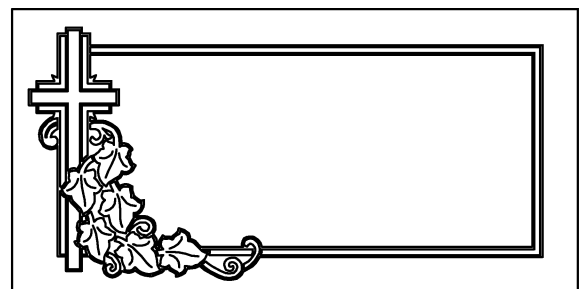

AG-M-208

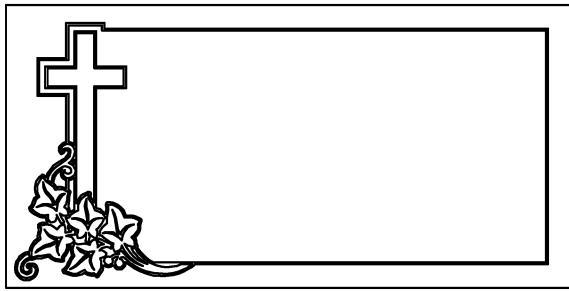

AG-M-209

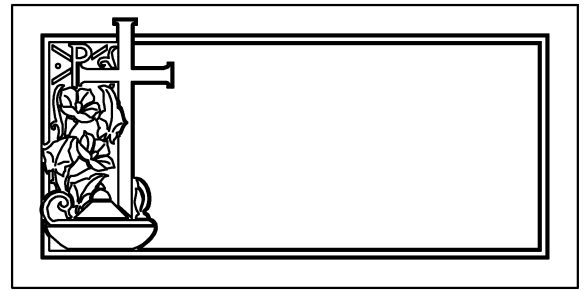

AG-M-210

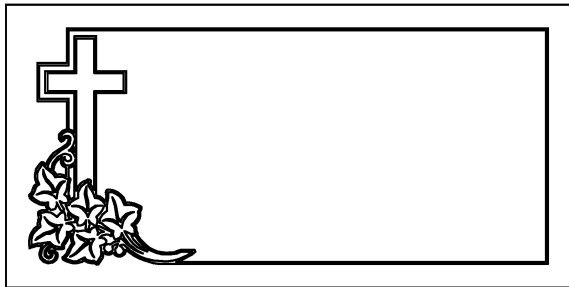

AG-M-211

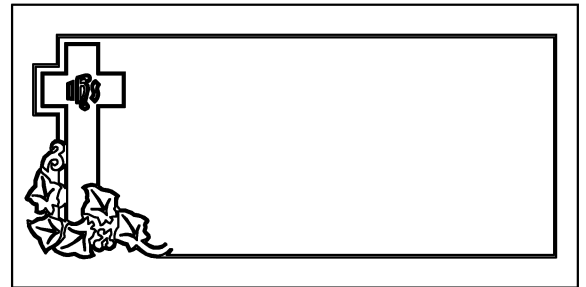

AG-M-212

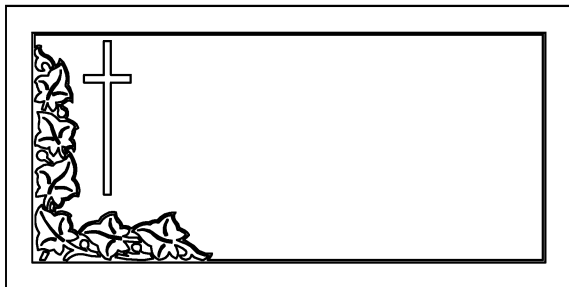

AG-M-213

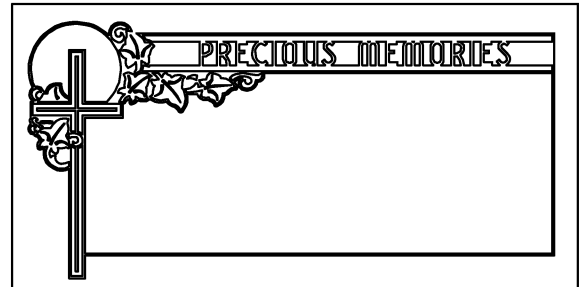

AG-M-214

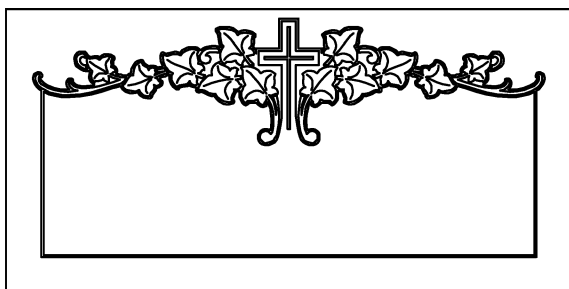

AG-M-215

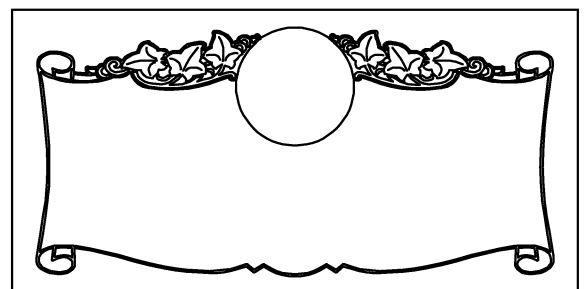

AG-M-216

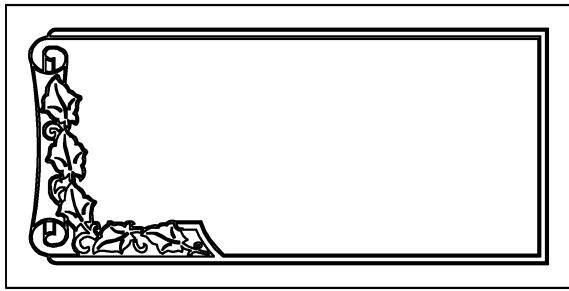

AG-M-217

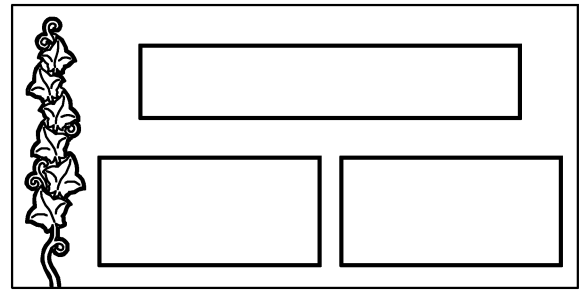

AG-M-218

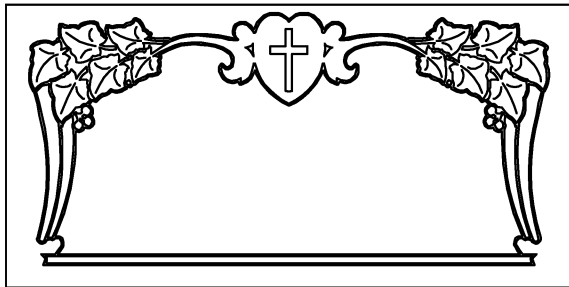

AG-M-219

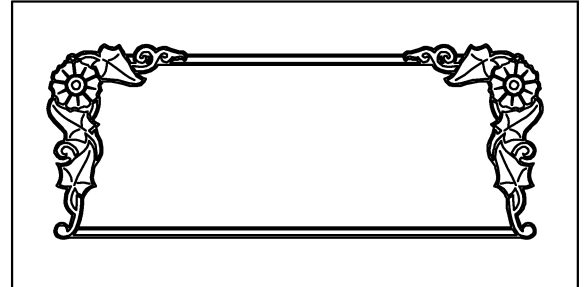

AG-M-220

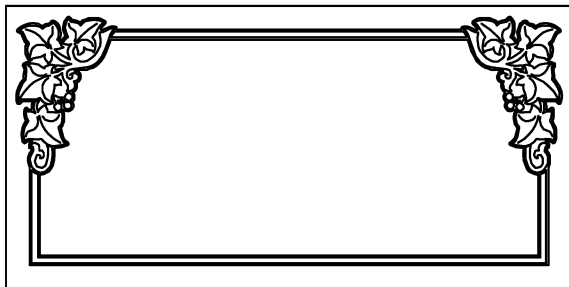

AG-M-221

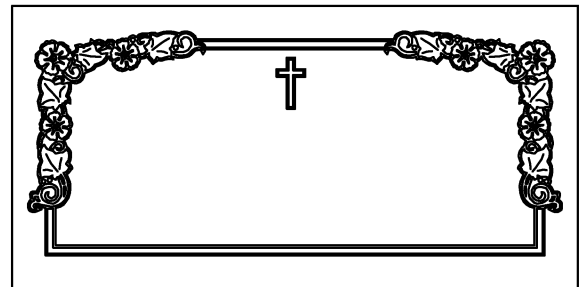

AG-M-222

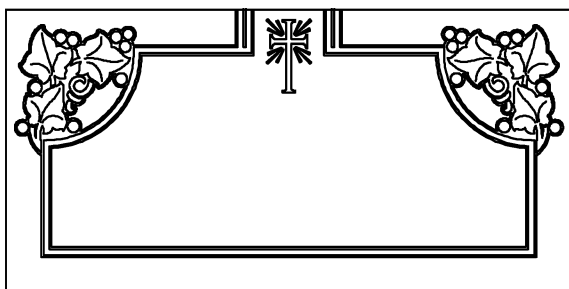

AG-M-223

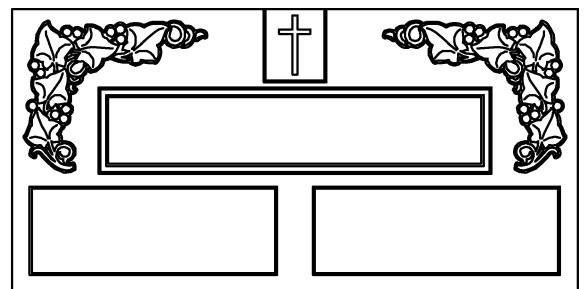

AG-M-224

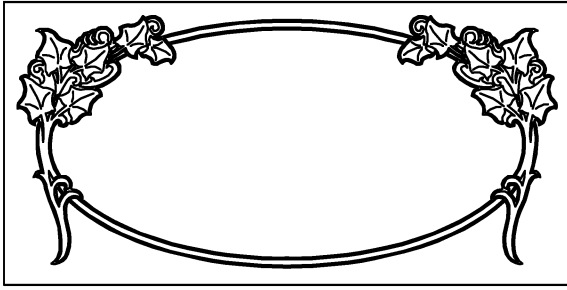

AG-M-225

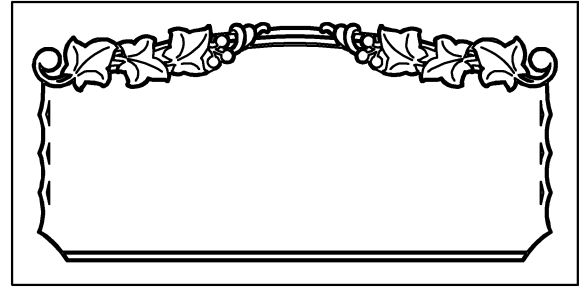

AG-M-226

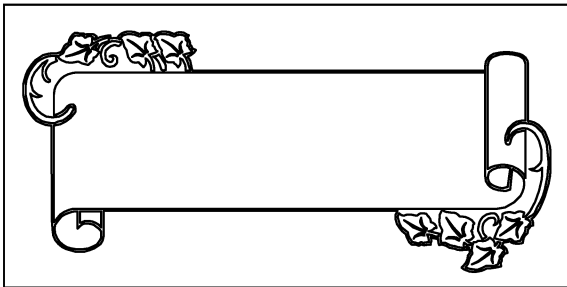

AG-M-227

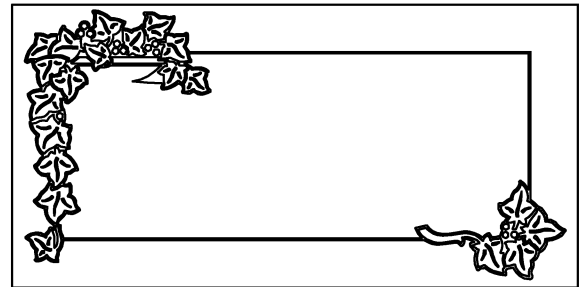

AG-M-228

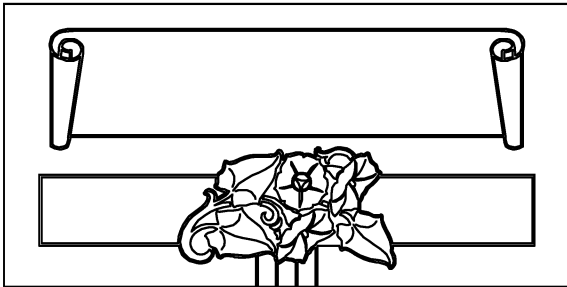

AG-M-229



AG-M-230

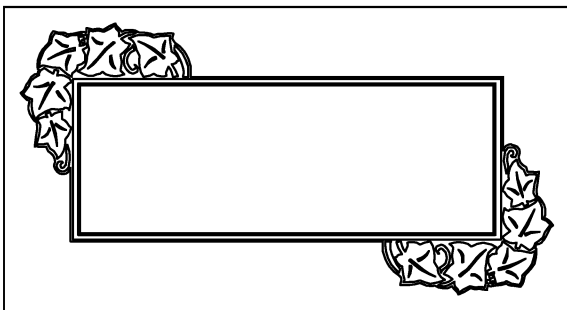

AG-M-231

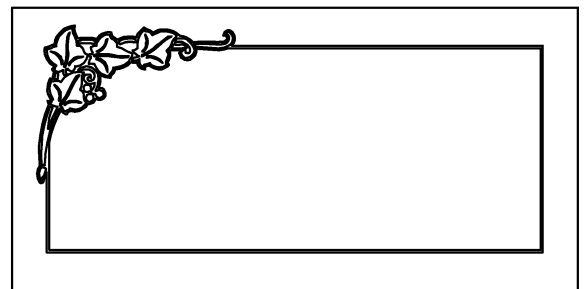

AG-M-232

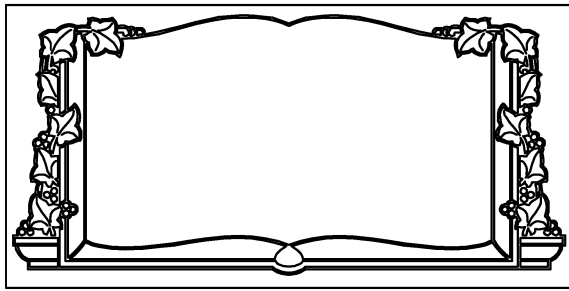

AG-M-233

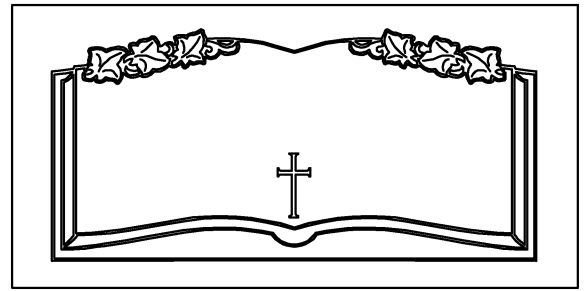

AG-M-234

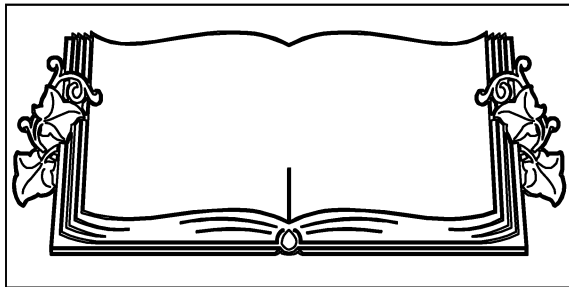

AG-M-235

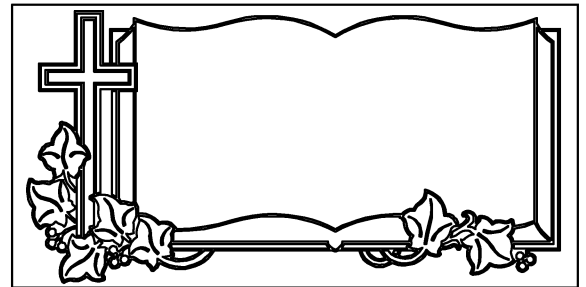

AG-M-236

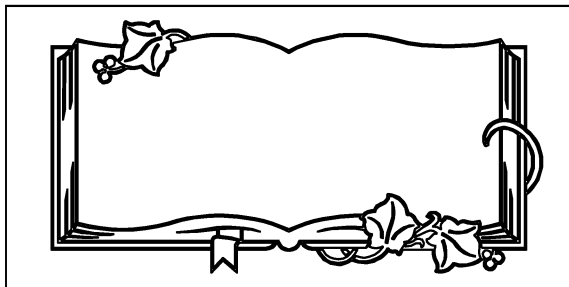

AG-M-237

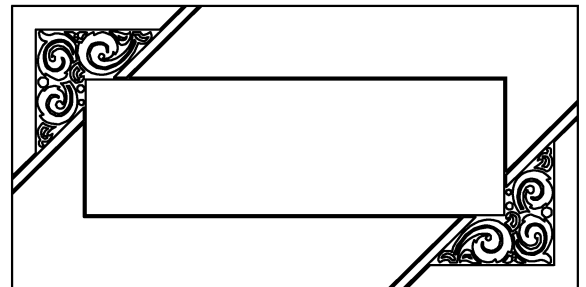

AG-M-238

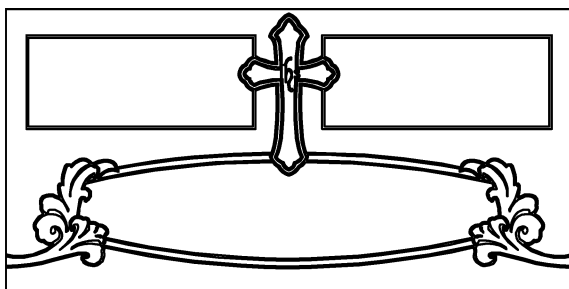

AG-M-239

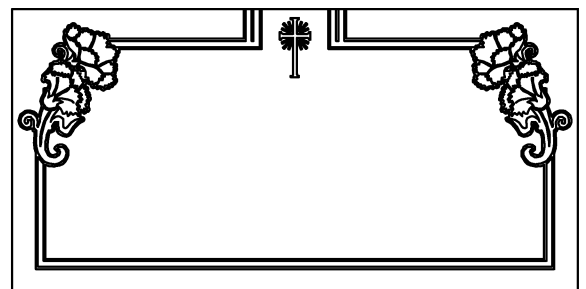

AG-M-240

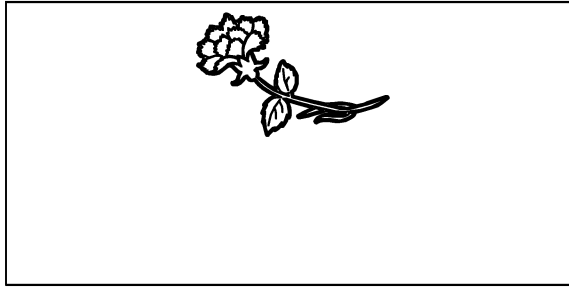

AG-M-241

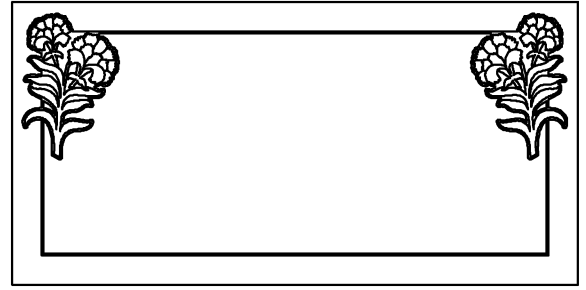

AG-M-242

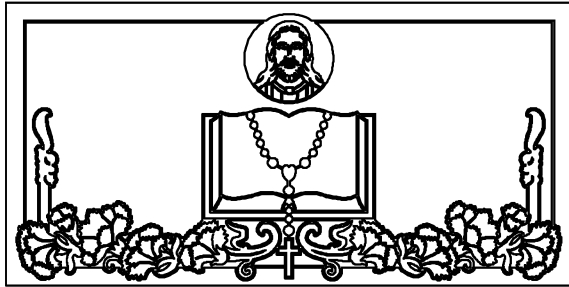

AG-M-243

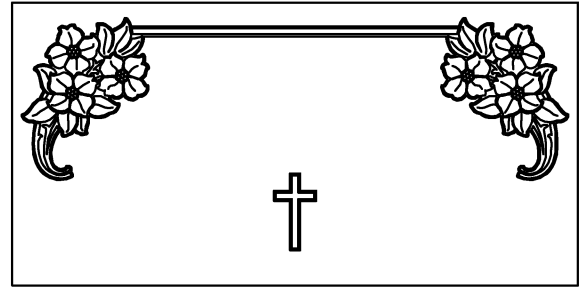

AG-M-244

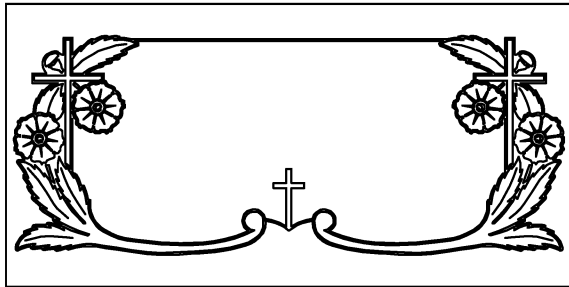

AG-M-245

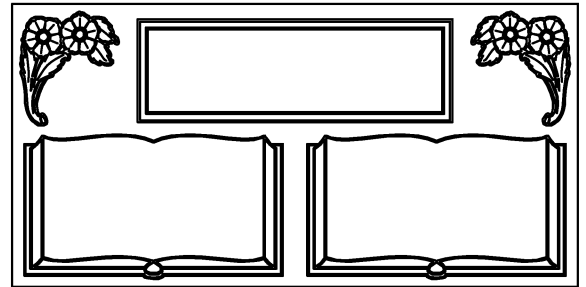

AG-M-246

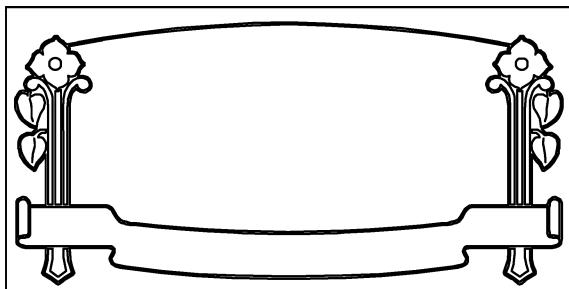

AG-M-247

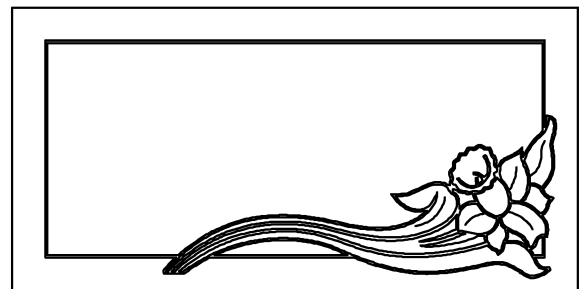

AG-M-248

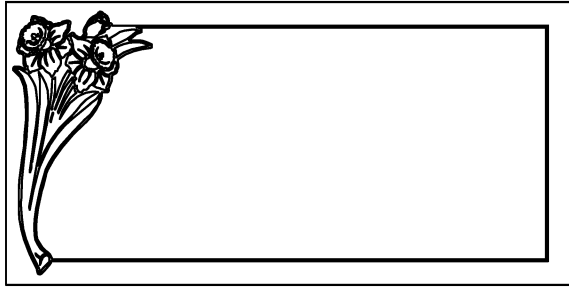

AG-M-249

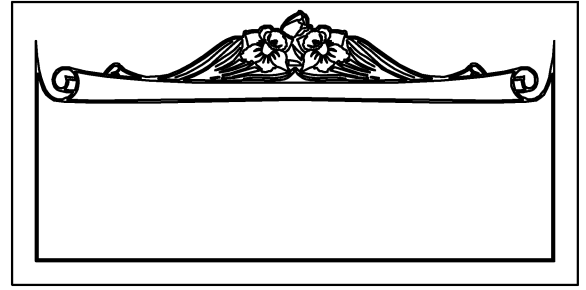

AG-M-250

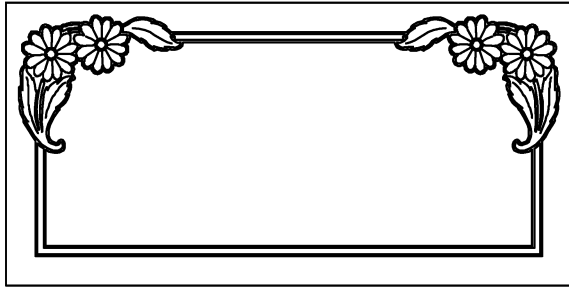

AG-M-251

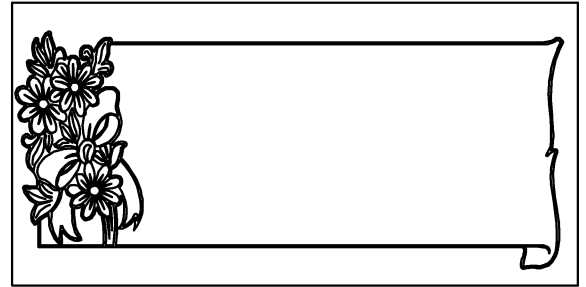

AG-M-252

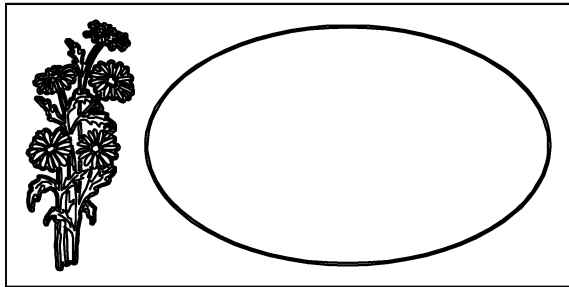

AG-M-253

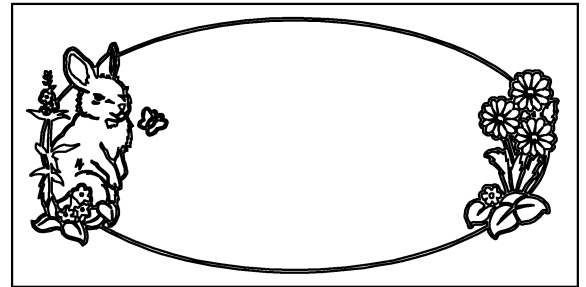

AG-M-254

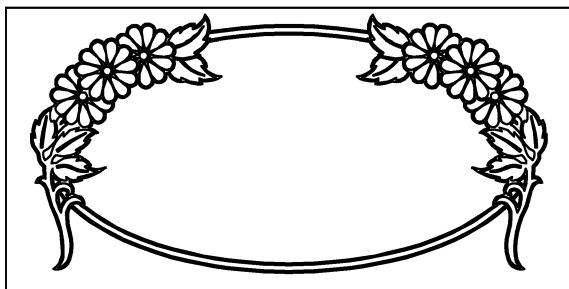

AG-M-255

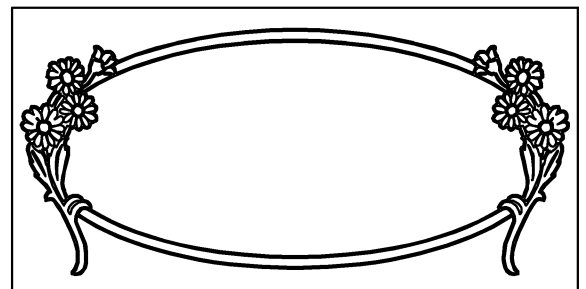

AG-M-256

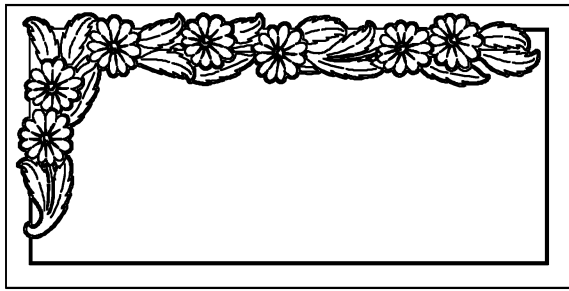

AG-M-257

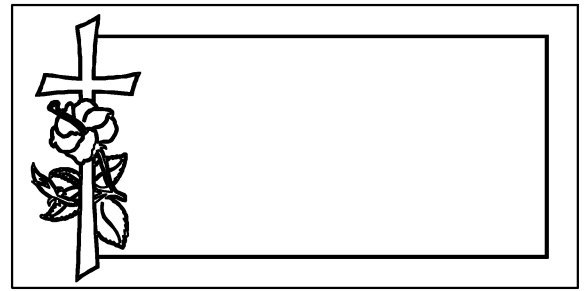

AG-M-258

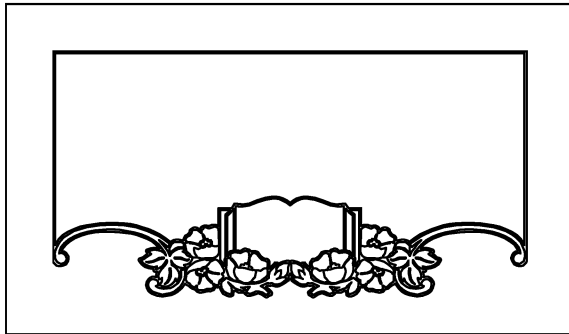

AG-M-259



AG-M-260

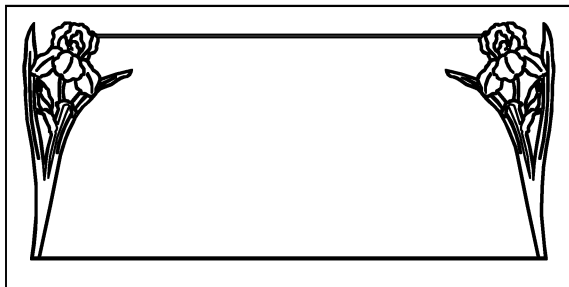

AG-M-261

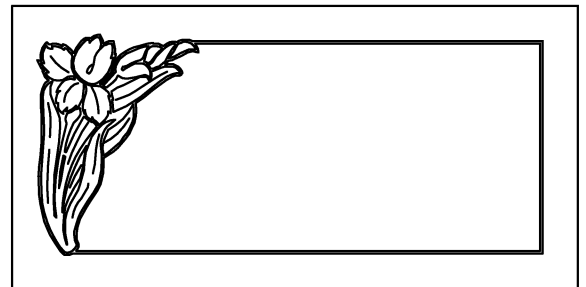

AG-M-262

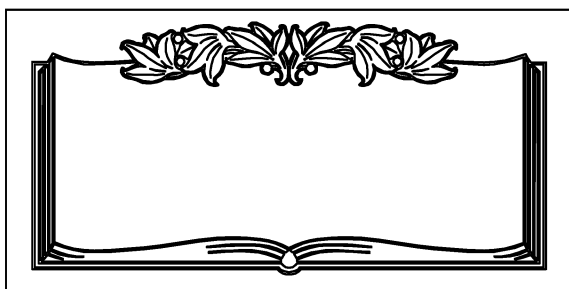

AG-M-263

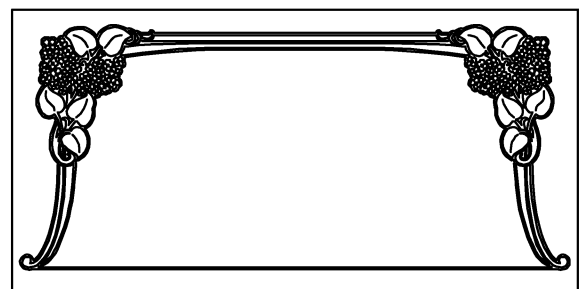

AG-M-264

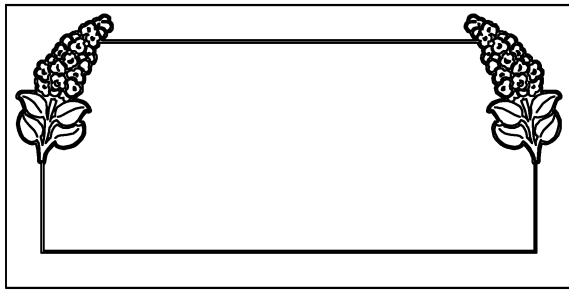

AG-M-265

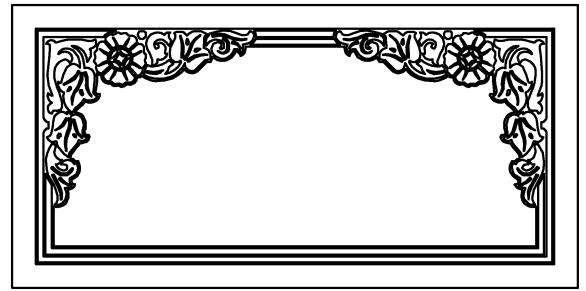

AG-M-266

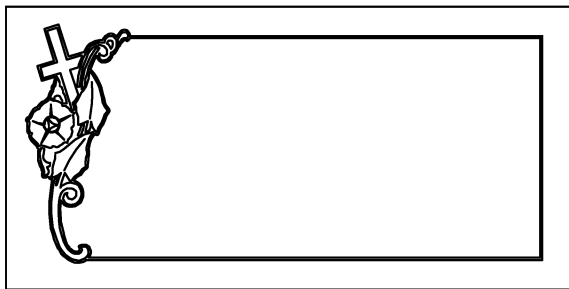

AG-M-267

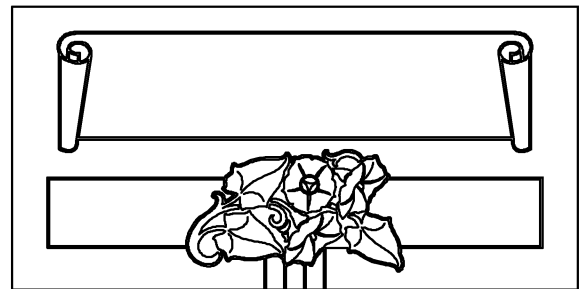

AG-M-268

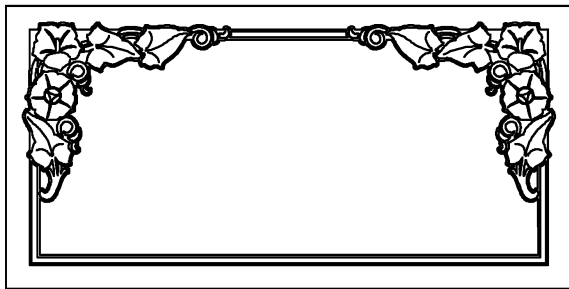

AG-M-269

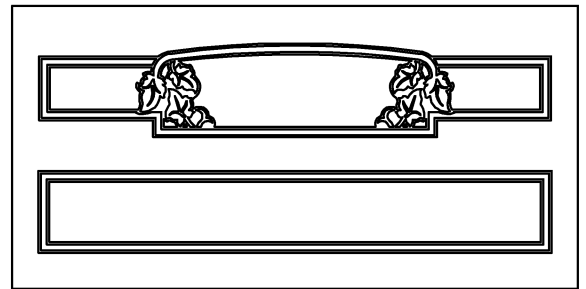

AG-M-270

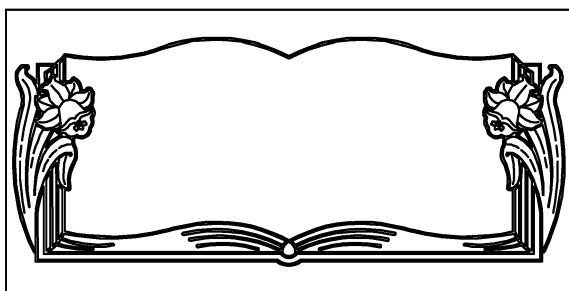

AG-M-271

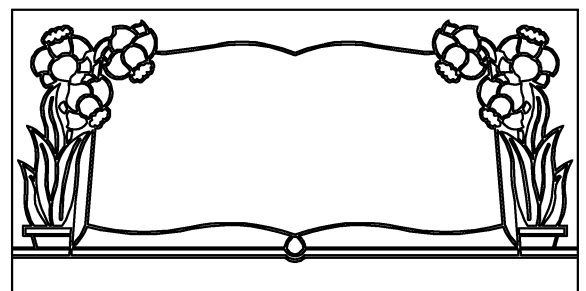

AG-M-272

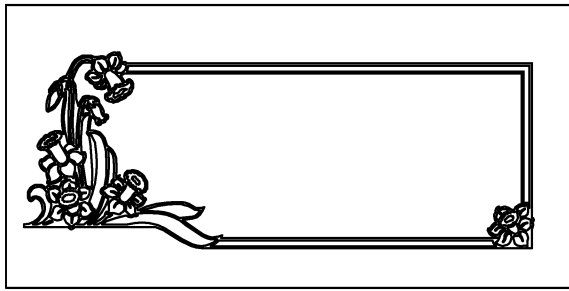

AG-M-273

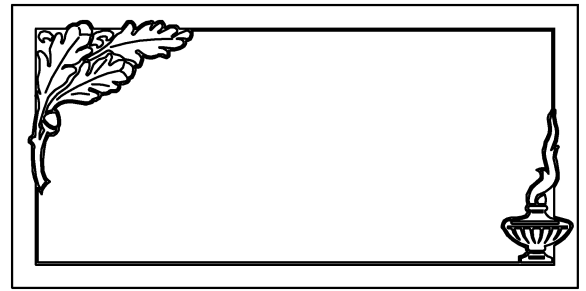

AG-M-274

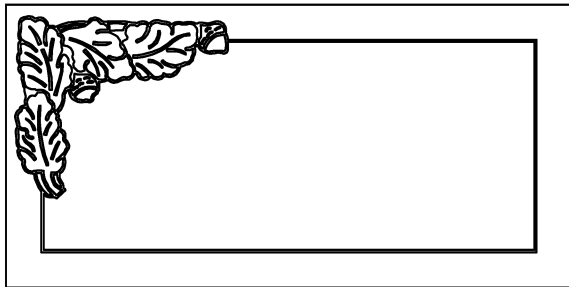

AG-M-275

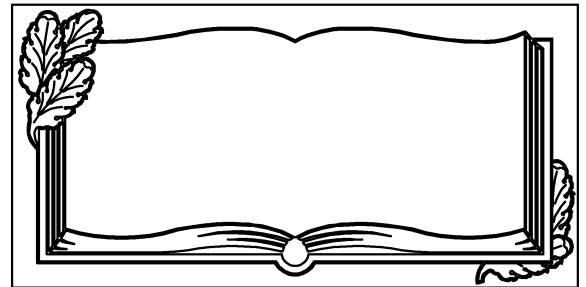

AG-M-276

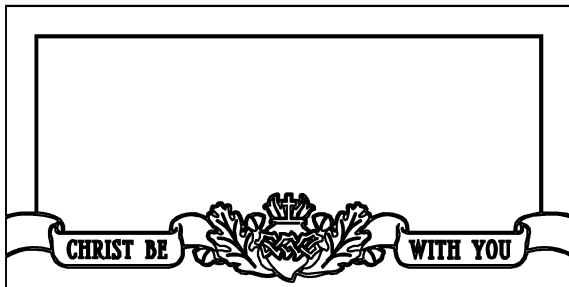

AG-M-277

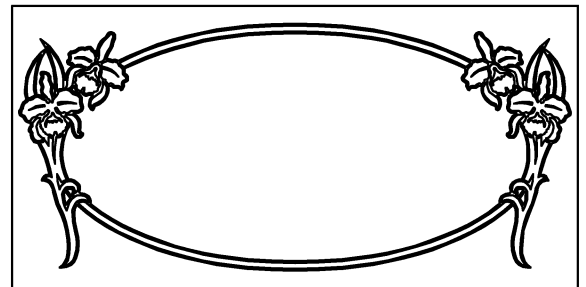

AG-M-278

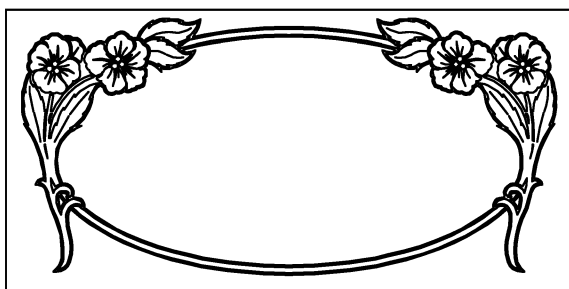

AG-M-279

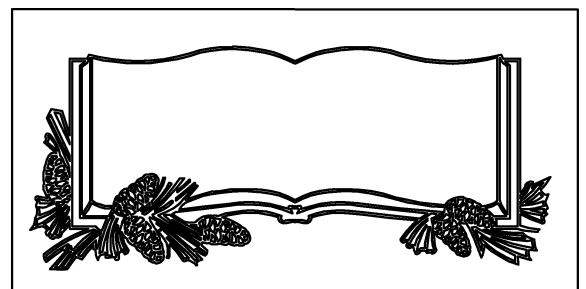

AG-M-280

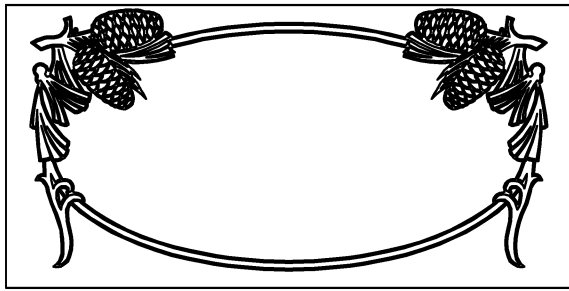

AG-M-281

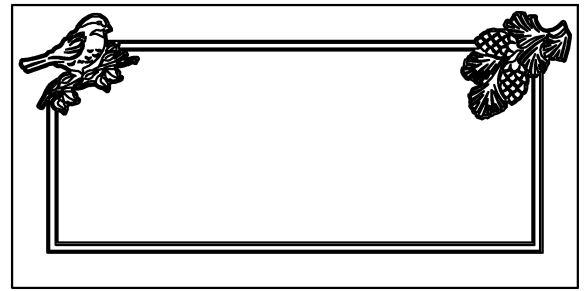

AG-M-282



AG-M-283

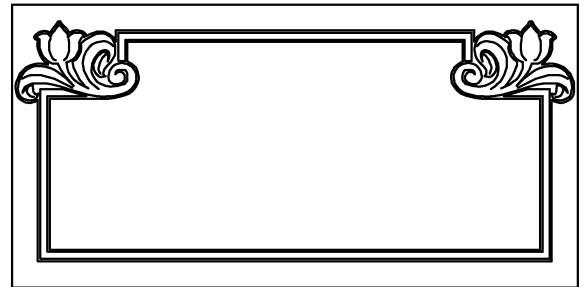

AG-M-284

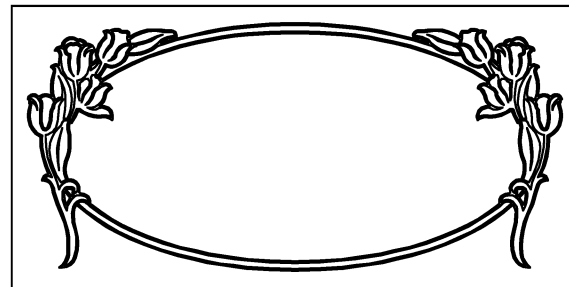

AG-M-285

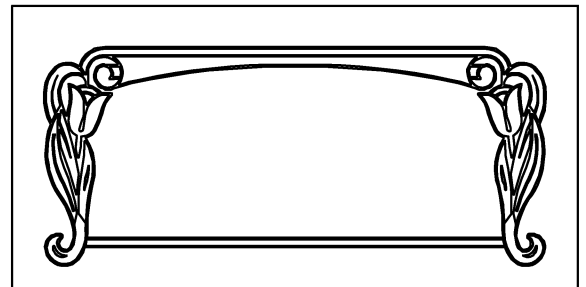

AG-M-286

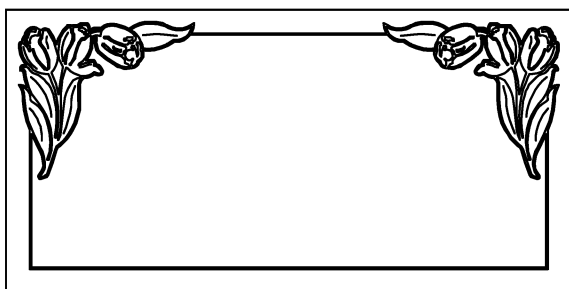

AG-M-287



AG-M-288

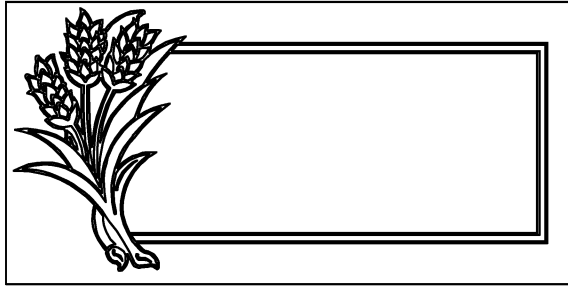

AG-M-289

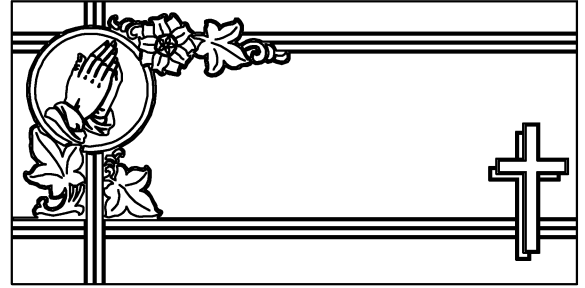

AG-M-290

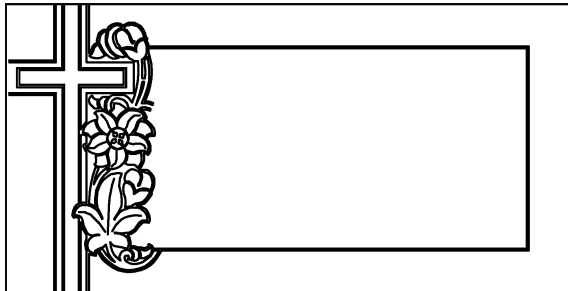

AG-M-291

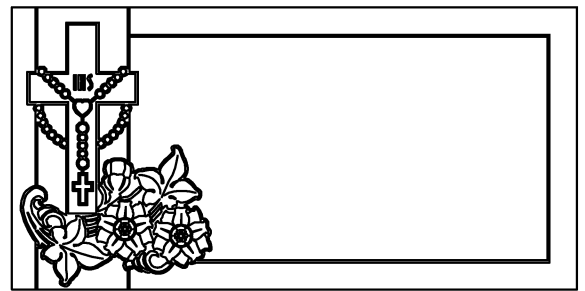

AG-M-292

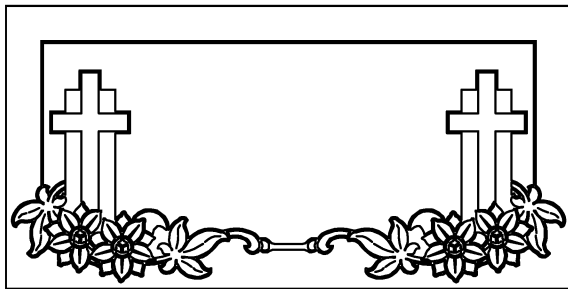

AG-M-293

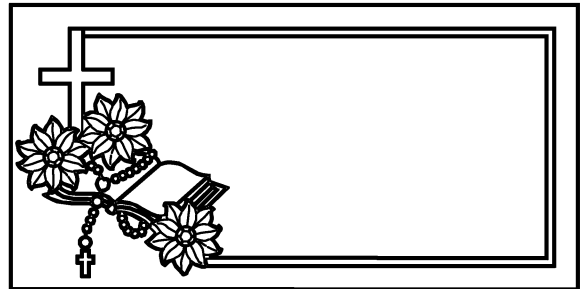

AG-M-294



AG-M-295

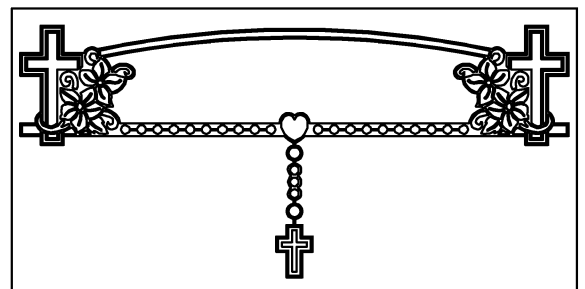

AG-M-296

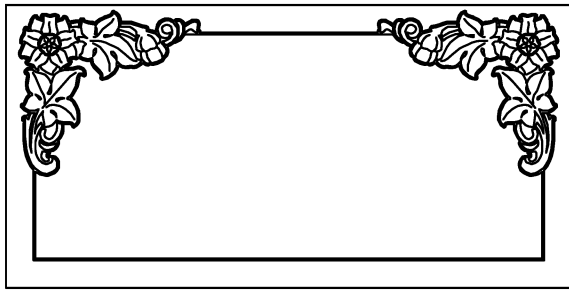

AG-M-297

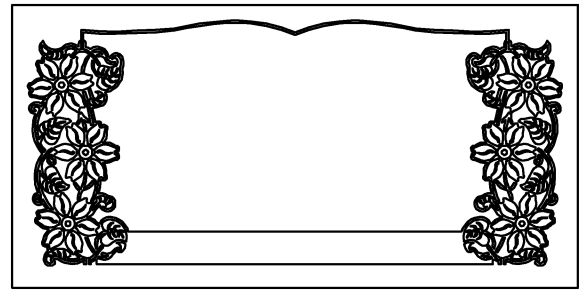

AG-M-298

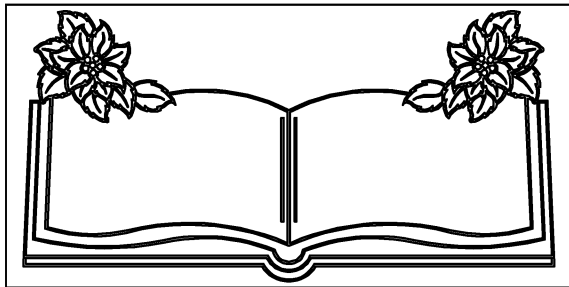

AG-M-299

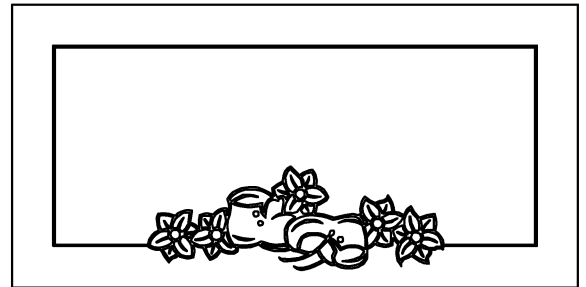

AG-M-300



AG-M-301

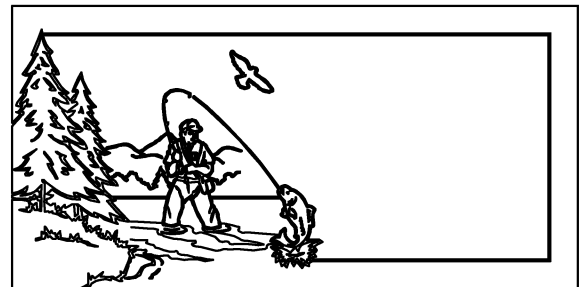

AG-M-302



AG-M-303

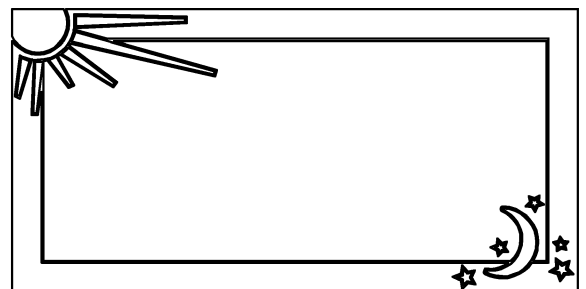

AG-M-304

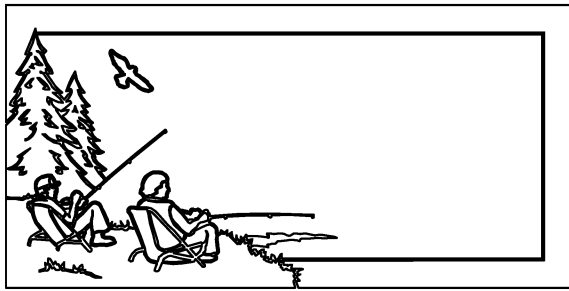

AG-M-305

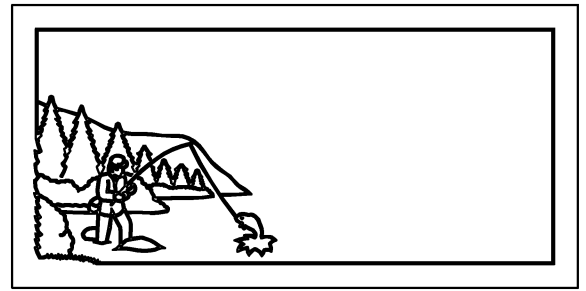

AG-M-306

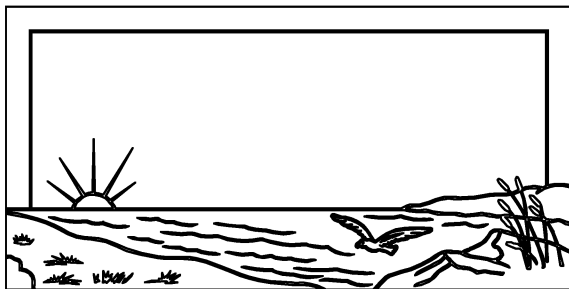

AG-M-307

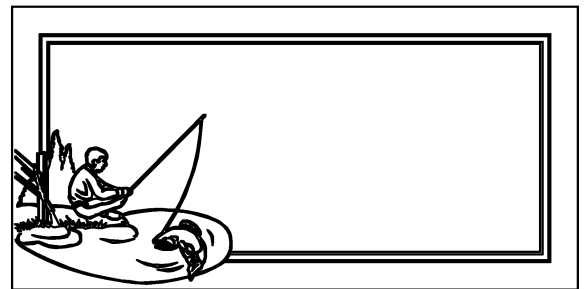

AG-M-308

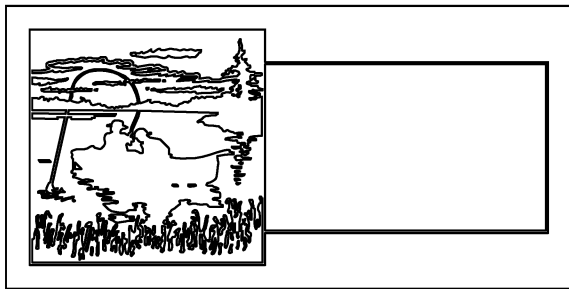

AG-M-309

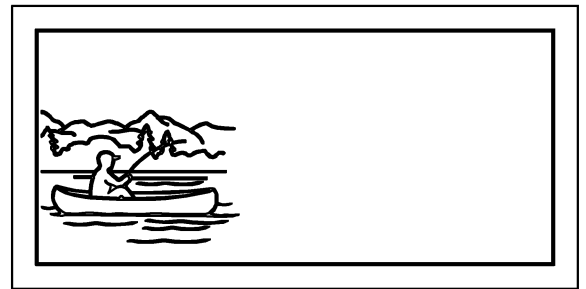

AG-M-310

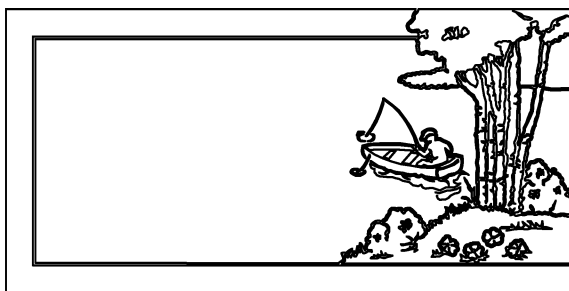

AG-M-311



AG-M-312

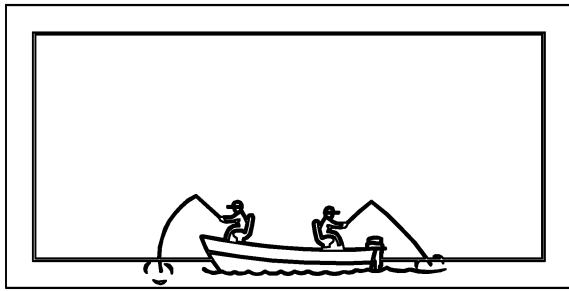

AG-M-313

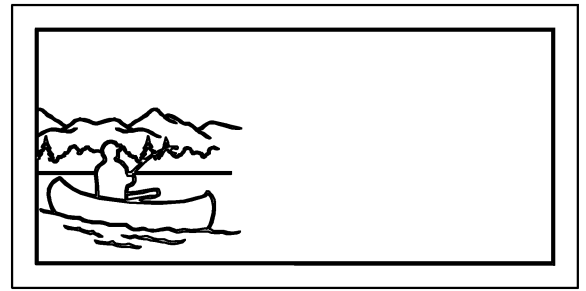

AG-M-314

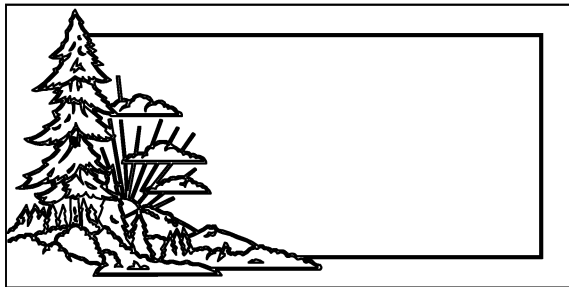

AG-M-315

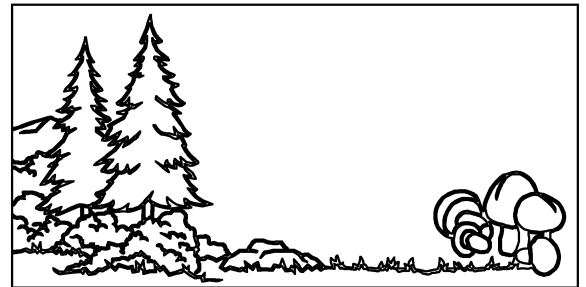

AG-M-316

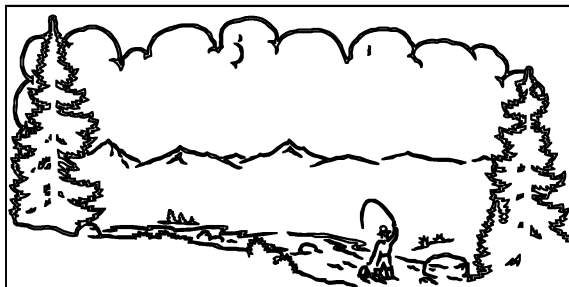

AG-M-317



AG-M-318

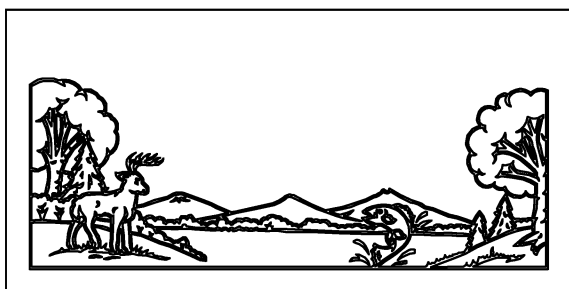

AG-M-319

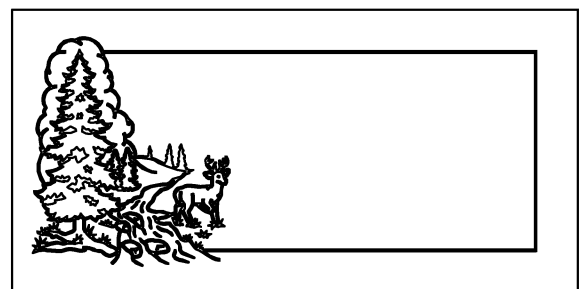

AG-M-320

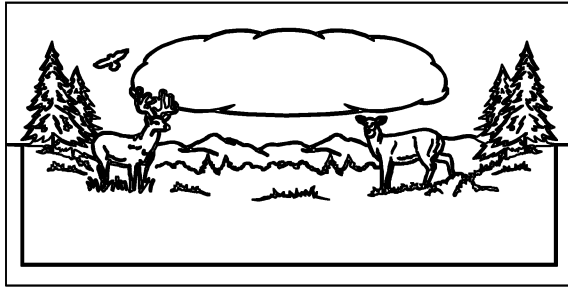

AG-M-321

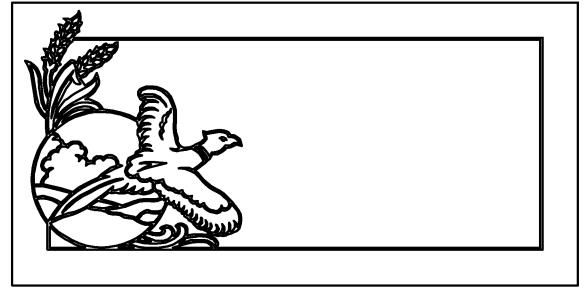

AG-M-322

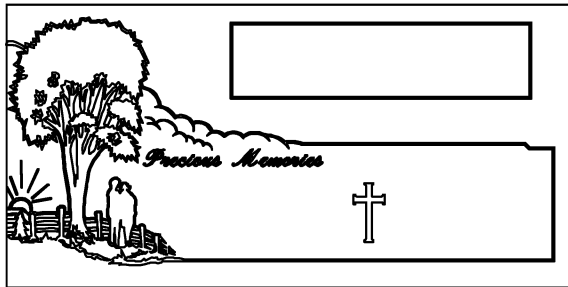

AG-M-323

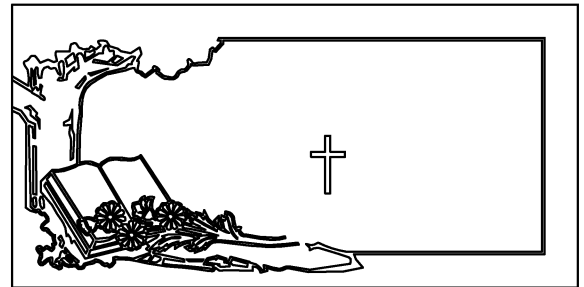

AG-M-324

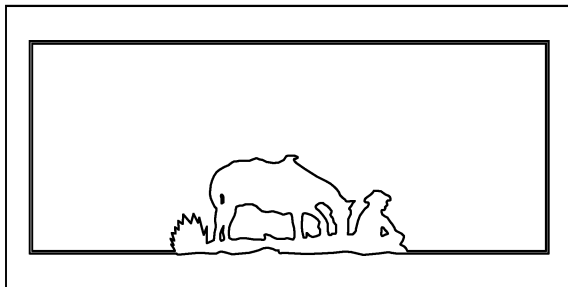

AG-M-325



AG-M-326

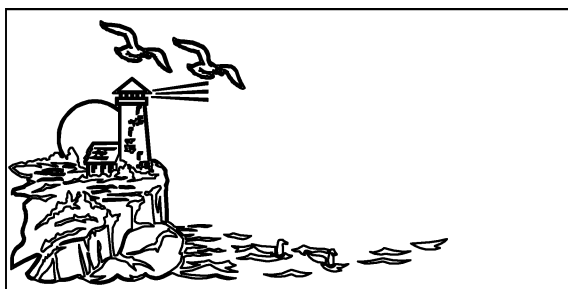

AG-M-327

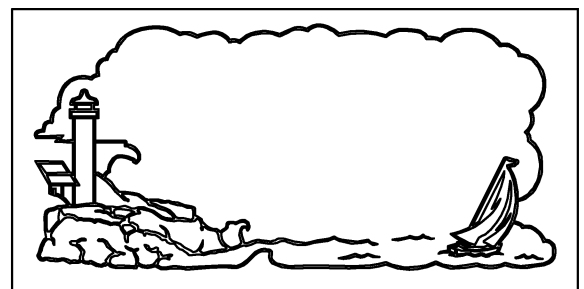

AG-M-328

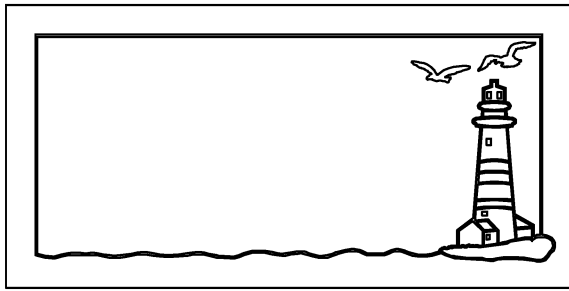

AG-M-329

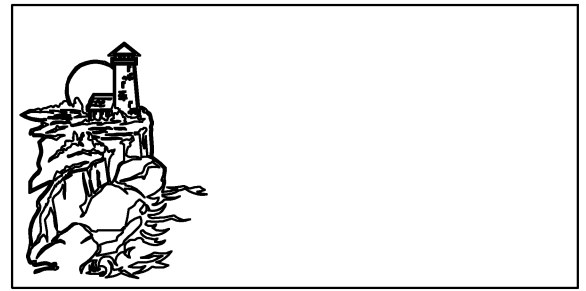

AG-M-330

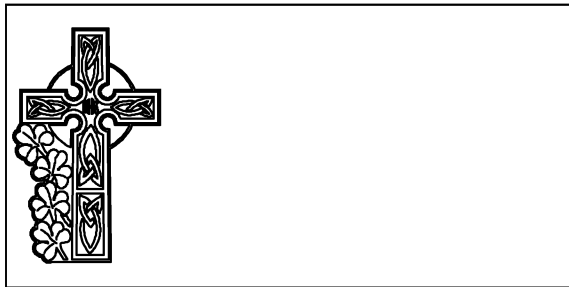

AG-M-331



AG-M-332

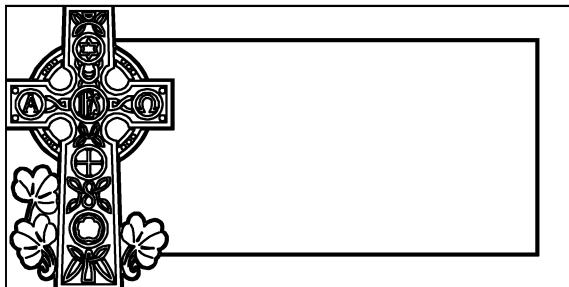

AG-M-333

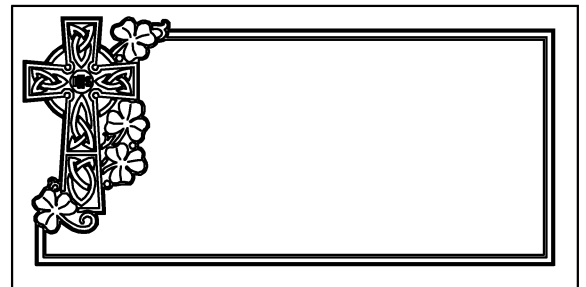

AG-M-334

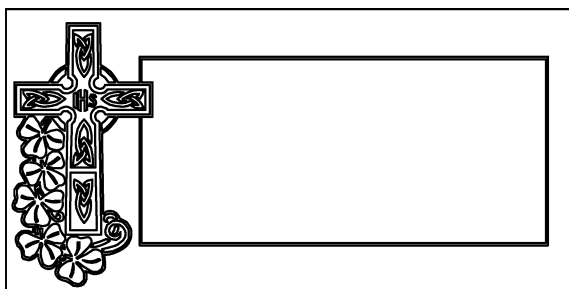

AG-M-335

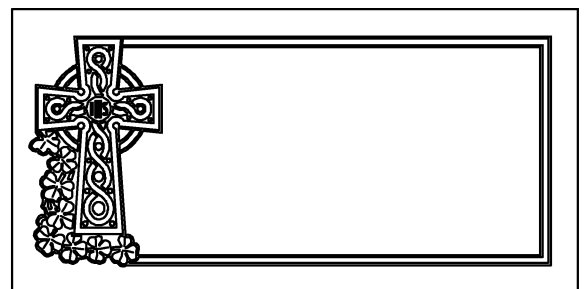

AG-M-336

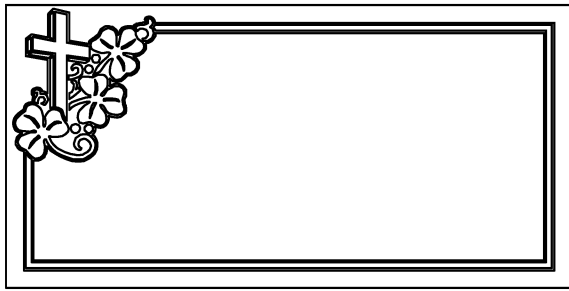

AG-M-337

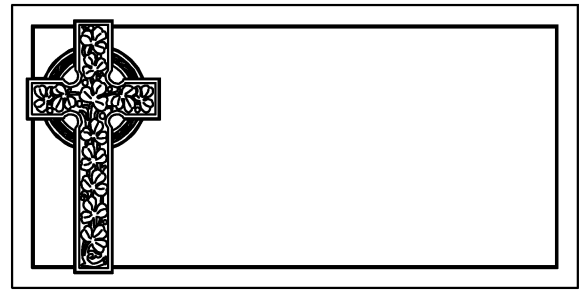

AG-M-338

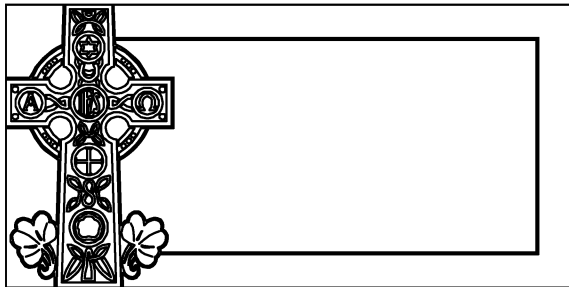

AG-M-339

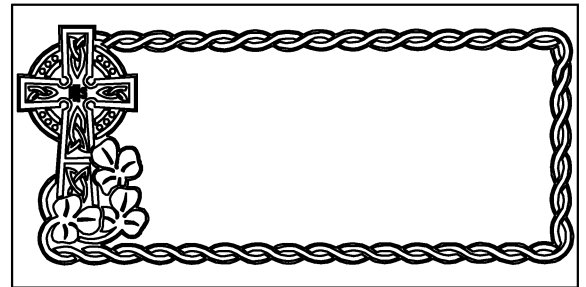

AG-M-340

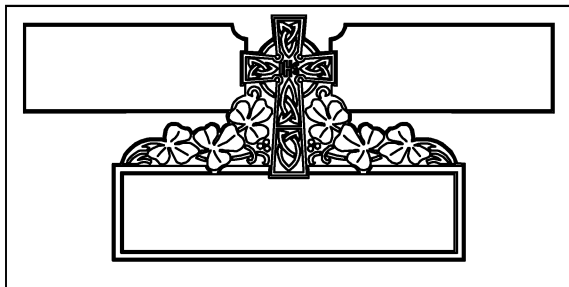

AG-M-341

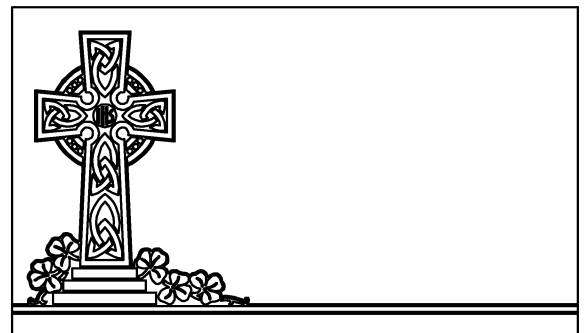

AG-M-342

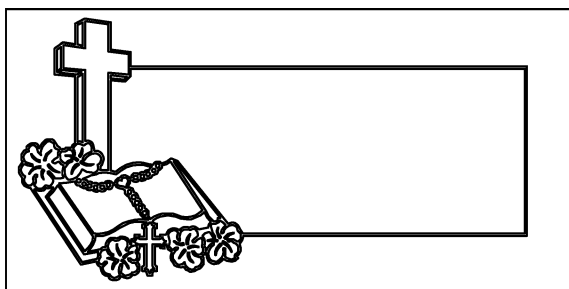

AG-M-343

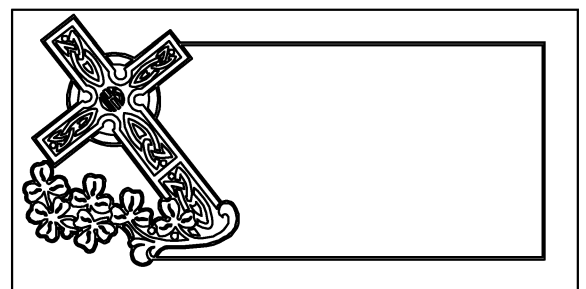

AG-M-344

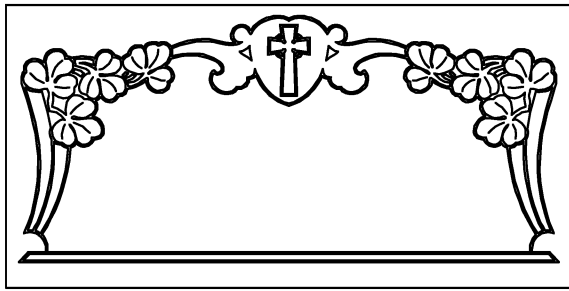

AG-M-345

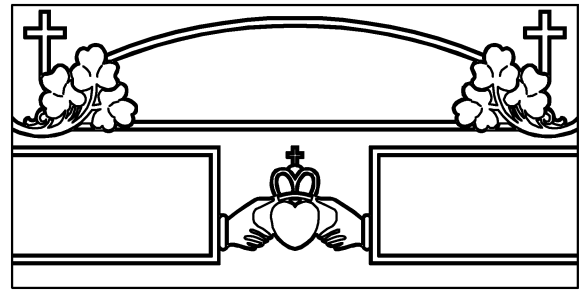

AG-M-346

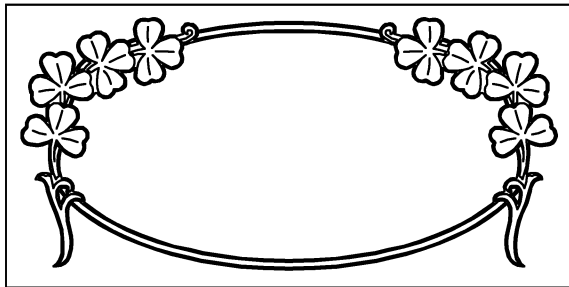

AG-M-347

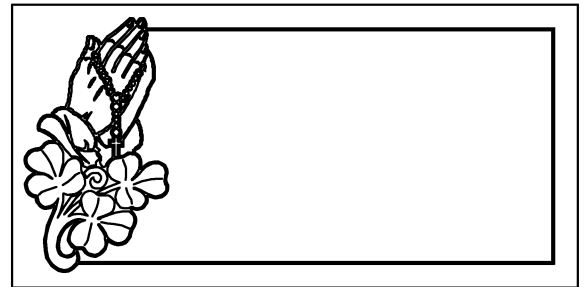

AG-M-348

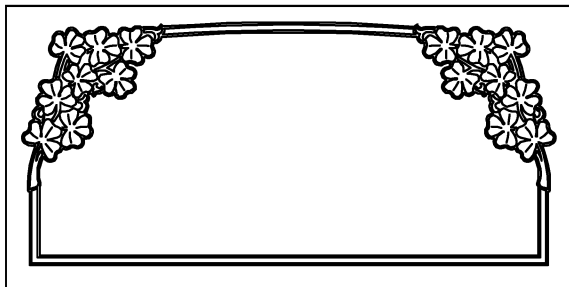

AG-M-349



AG-M-350

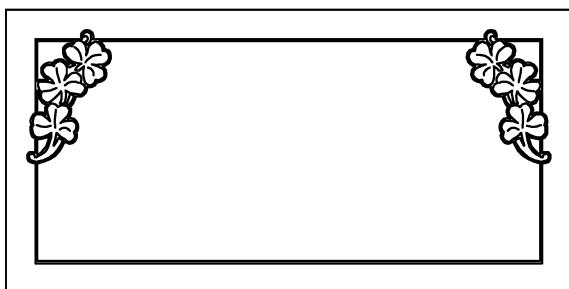

AG-M-351

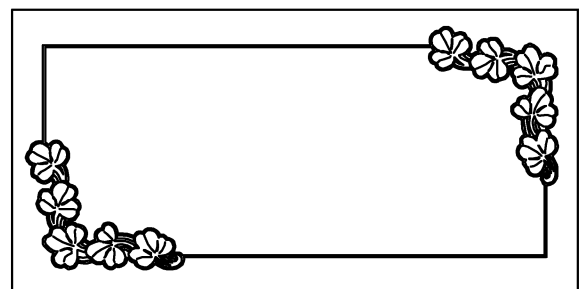

AG-M-352

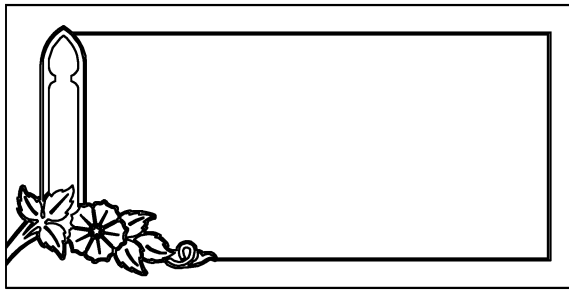

AG-M-353

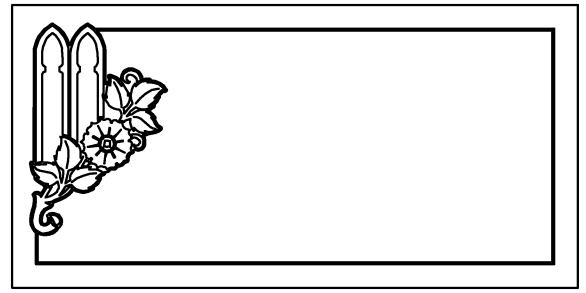

AG-M-354

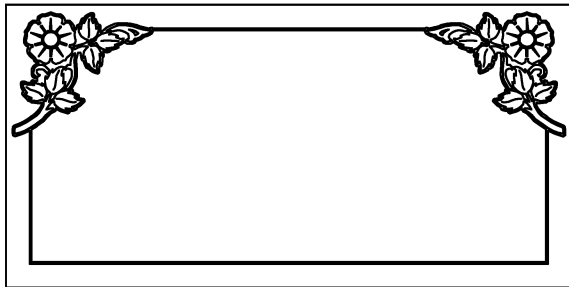

AG-M-355

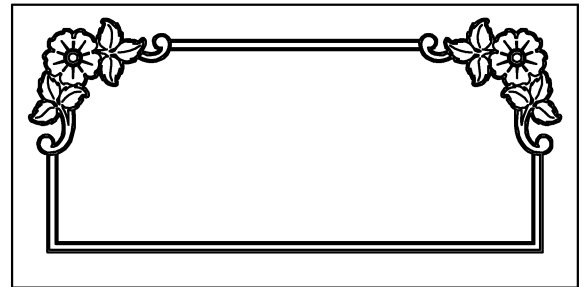

AG-M-356

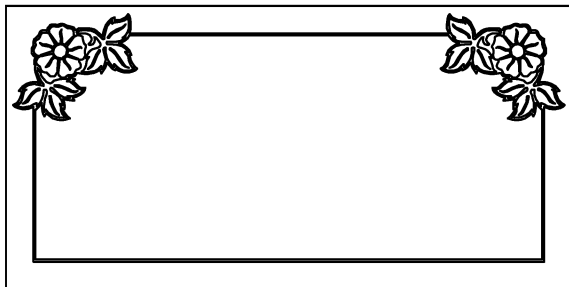

AG-M-357

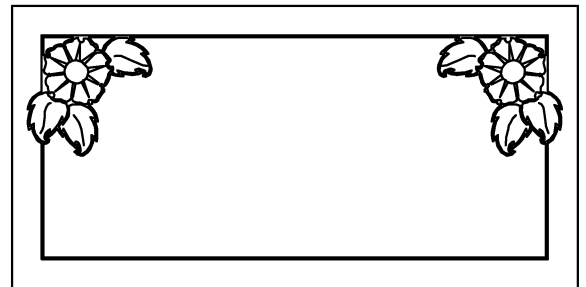

AG-M-358

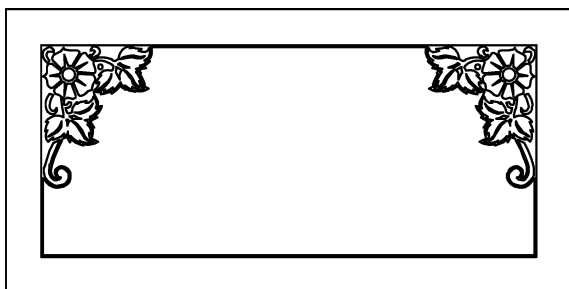

AG-M-359

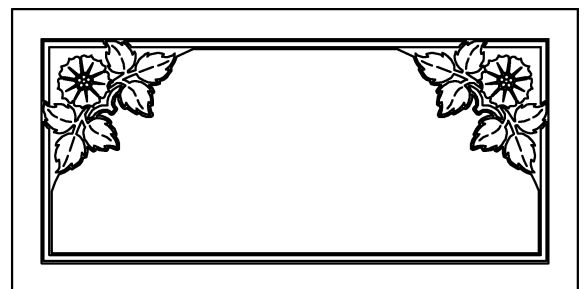

AG-M-360

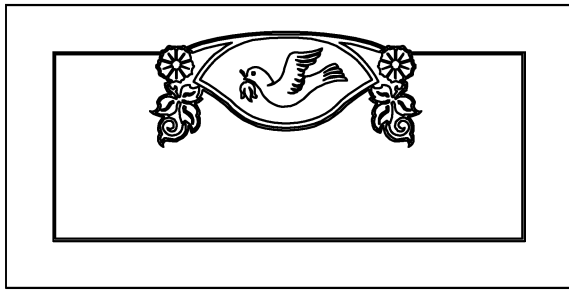

AG-M-361

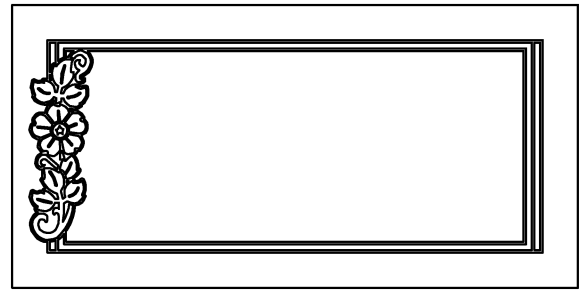

AG-M-362

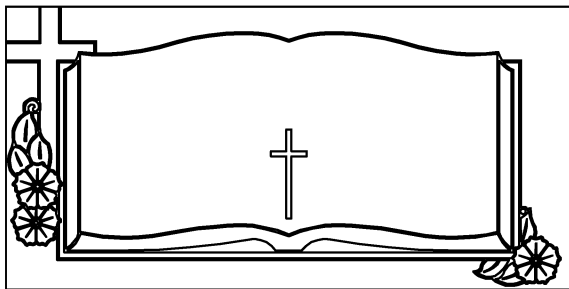

AG-M-363

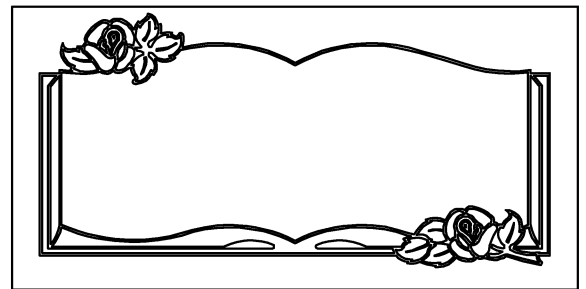

AG-M-364

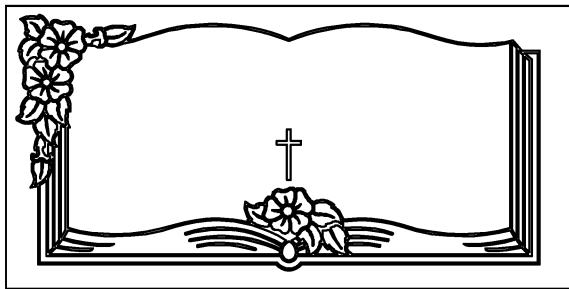

AG-M-365

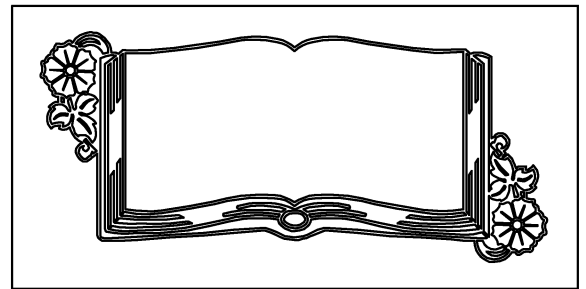

AG-M-366

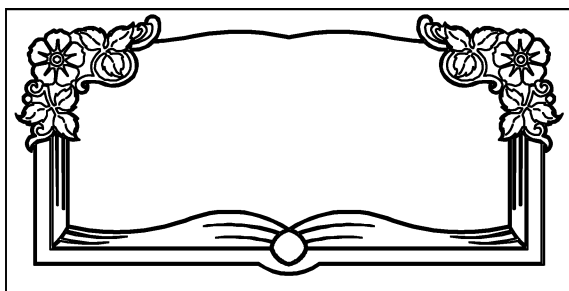

AG-M-367

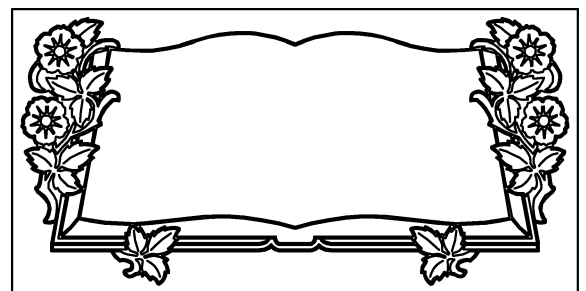

AG-M-368

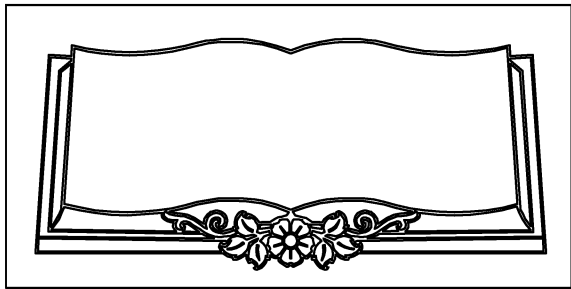

AG-M-369

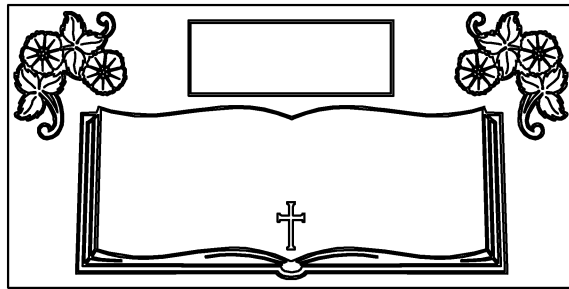

AG-M-370

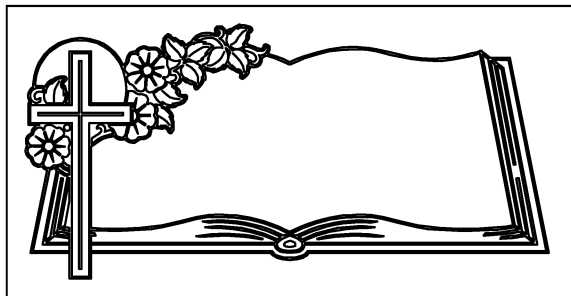

AG-M-371

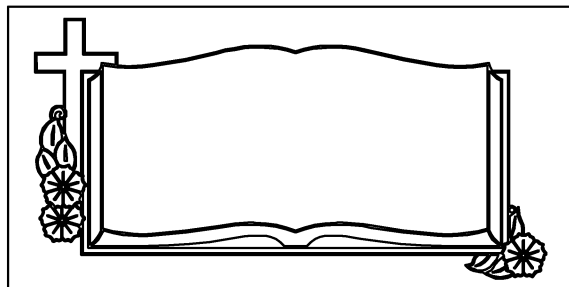

AG-M-372

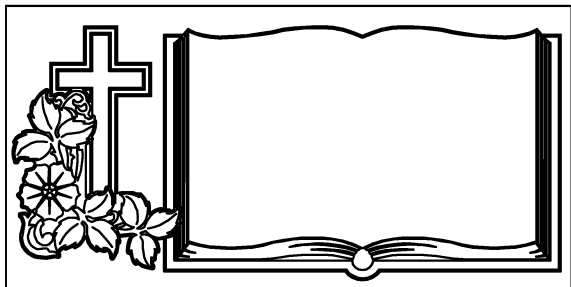

AG-M-373

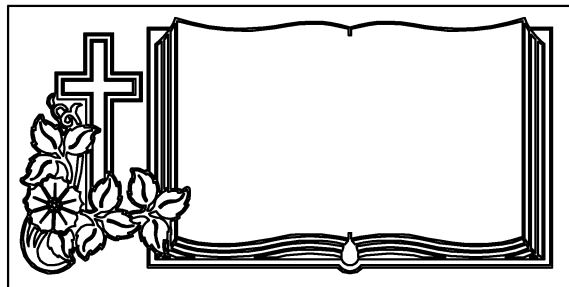

AG-M-374

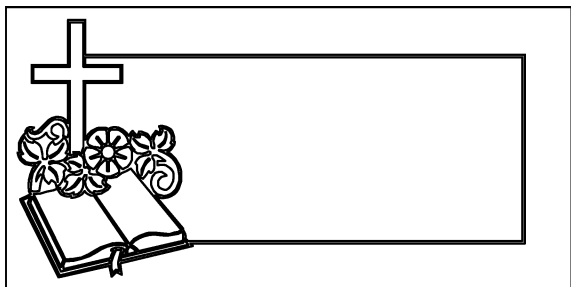

AG-M-375

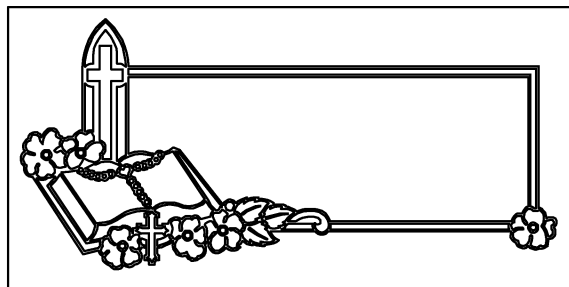

AG-M-376

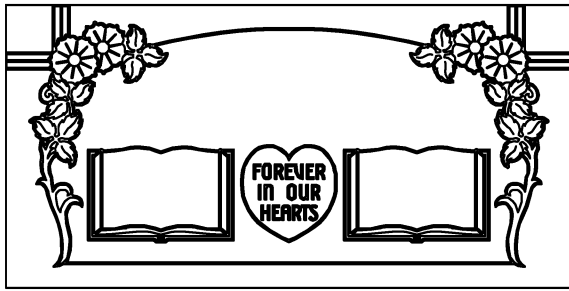

AG-M-377

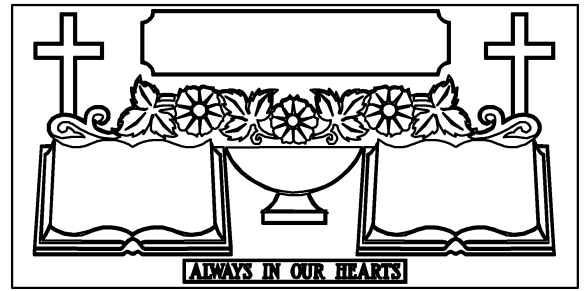

AG-M-378

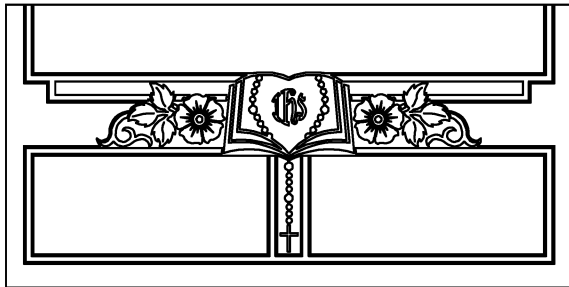

AG-M-379

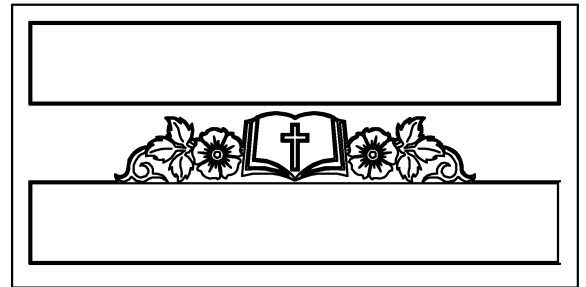

AG-M-380

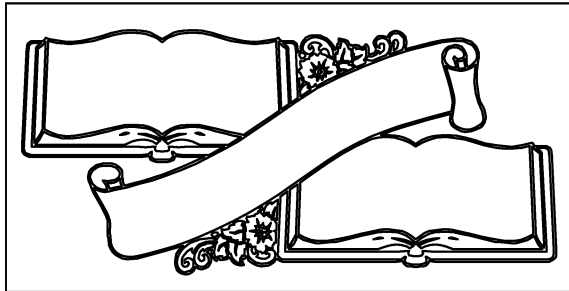

AG-M-381

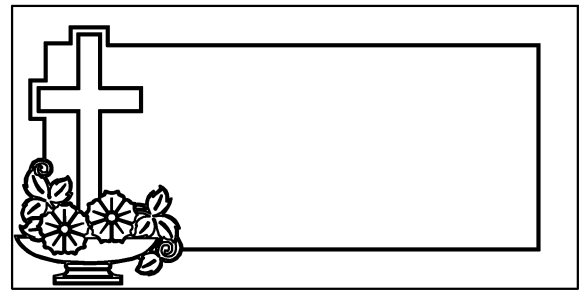

AG-M-382

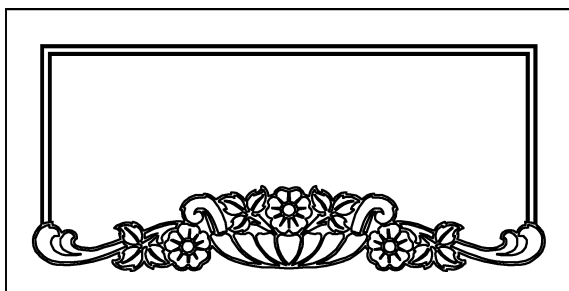

AG-M-383

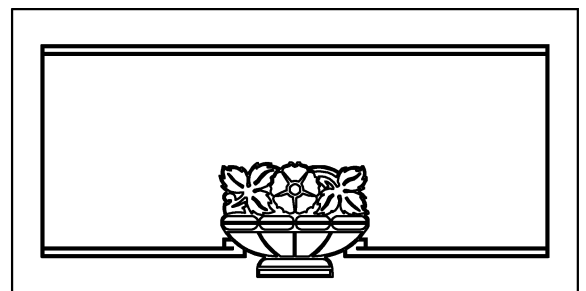

AG-M-384

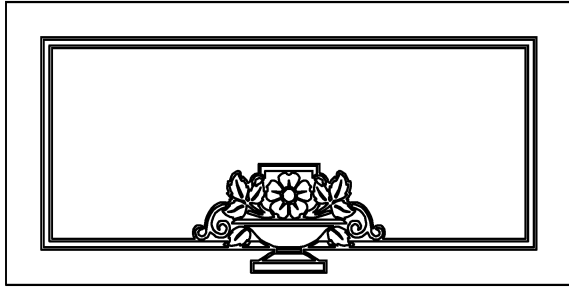

AG-M-385

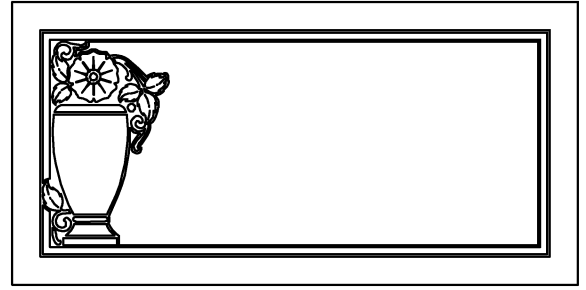

AG-M-386

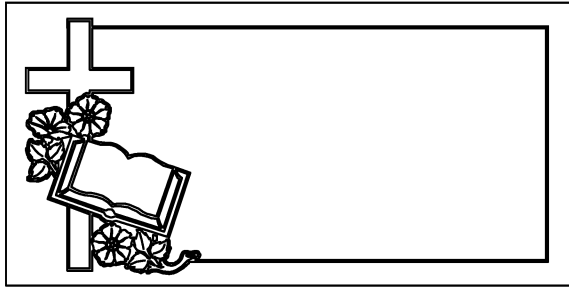

AG-M-387

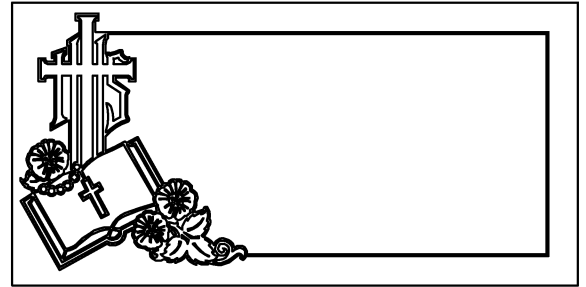

AG-M-388

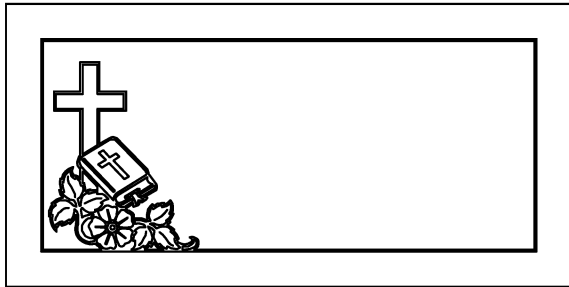

AG-M-389

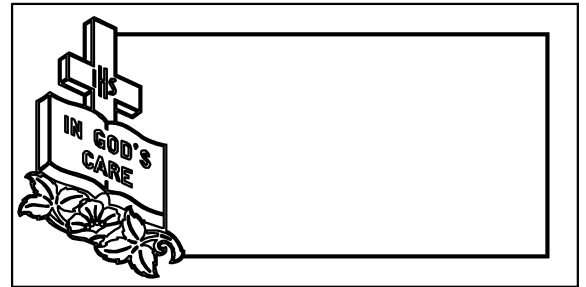

AG-M-390

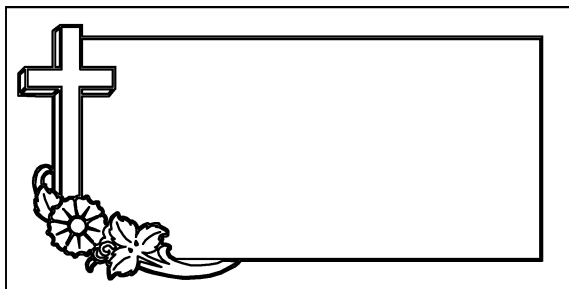

AG-M-391



AG-M-392

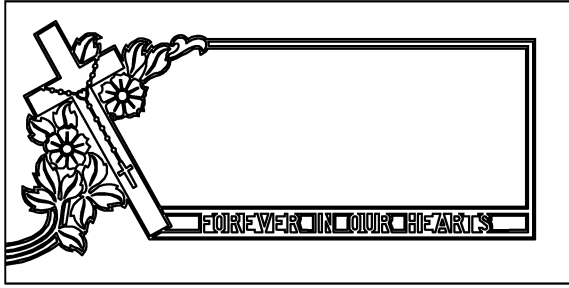

AG-M-393

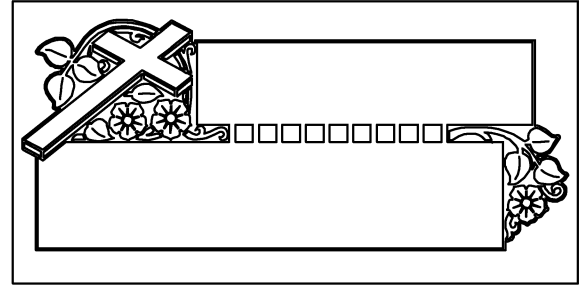

AG-M-394

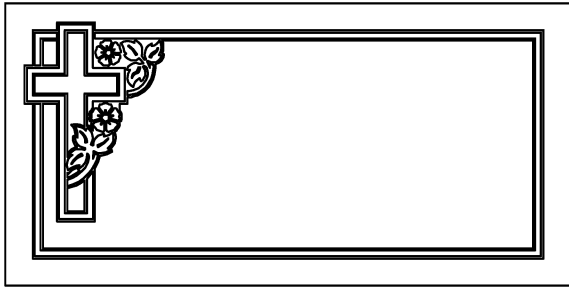

AG-M-395

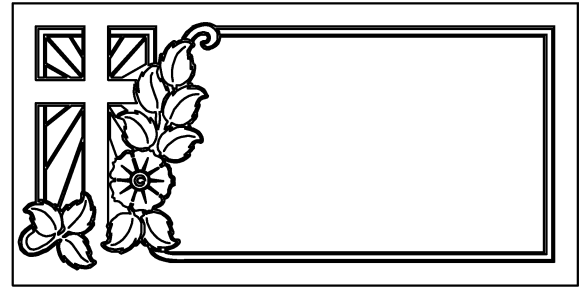

AG-M-396

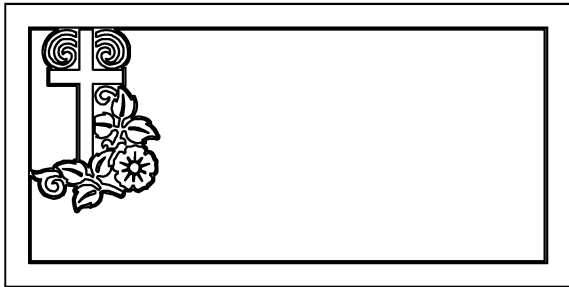

AG-M-397

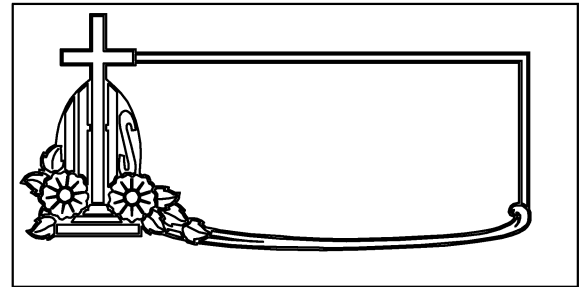

AG-M-398



AG-M-399

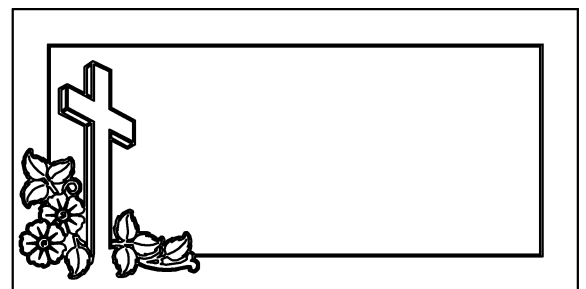

AG-M-400

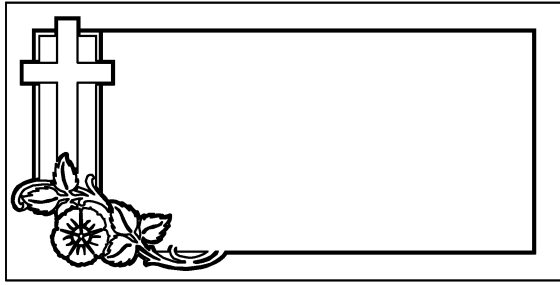

AG-M-401

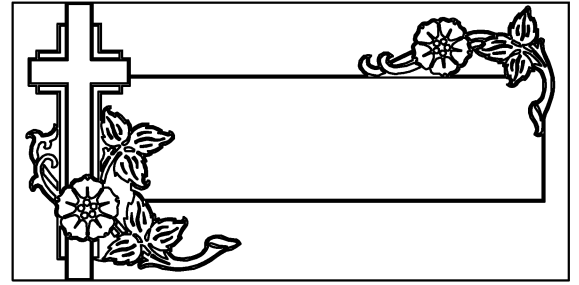

AG-M-402

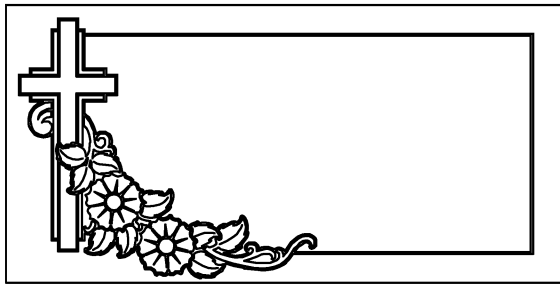

AG-M-403

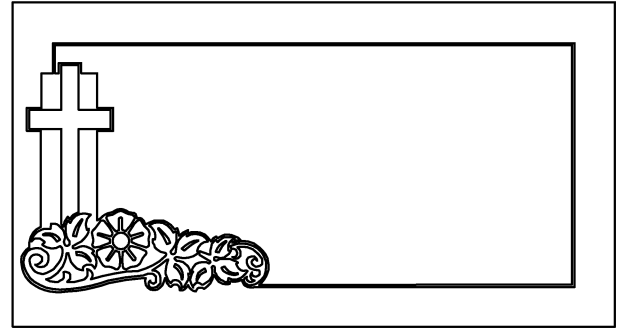

AG-M-404

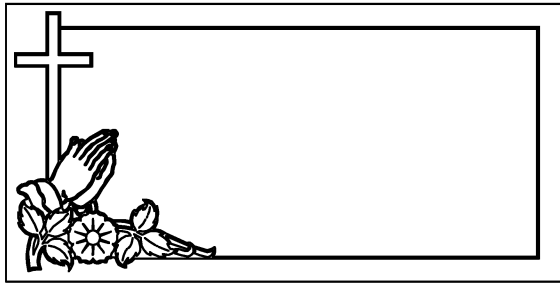

AG-M-405

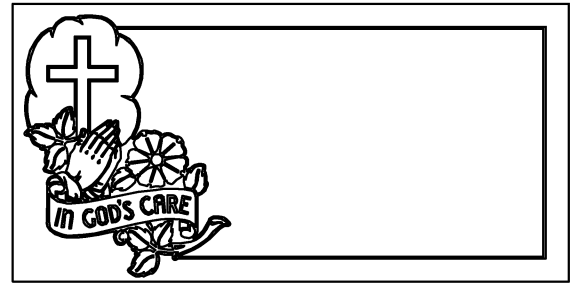

AG-M-406

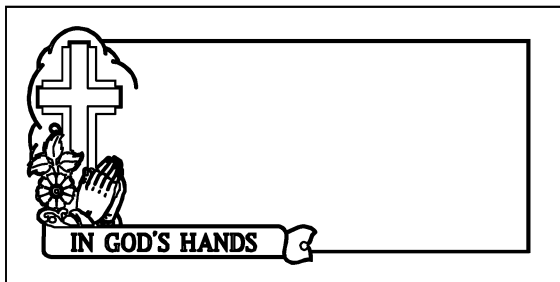

AG-M-407

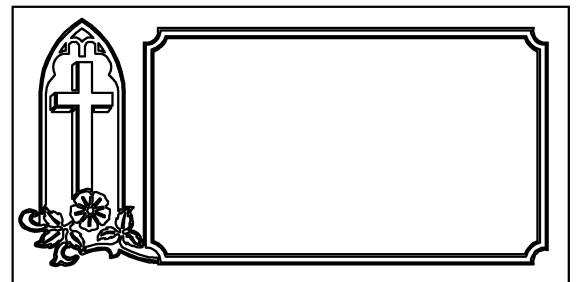

AG-M-408

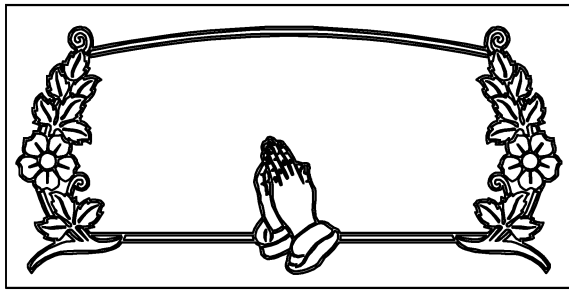

AG-M-409

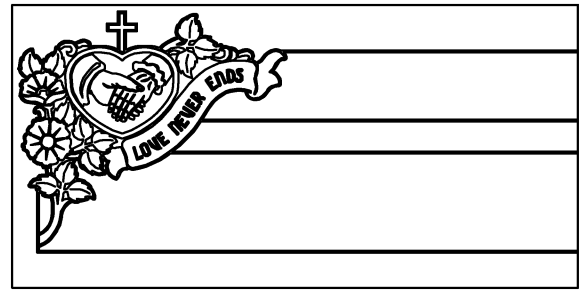

AG-M-410

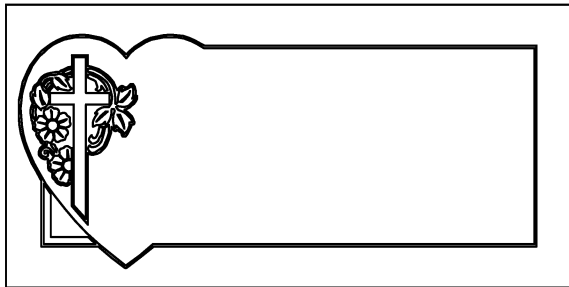

AG-M-411

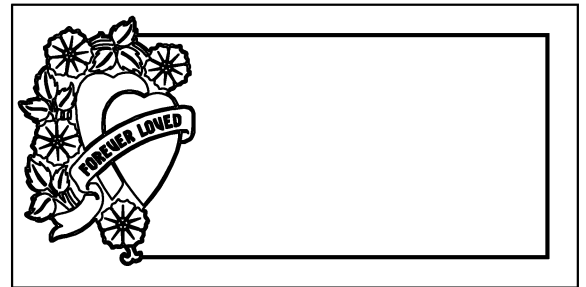

AG-M-412

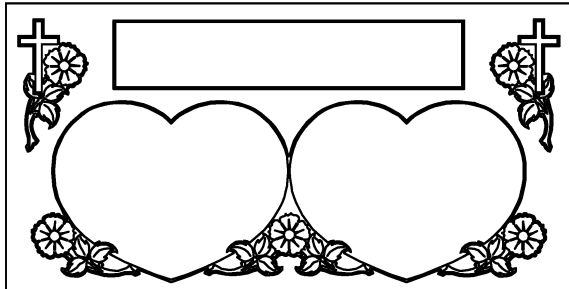

AG-M-413

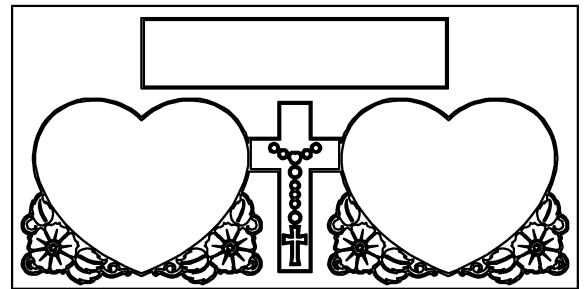

AG-M-414

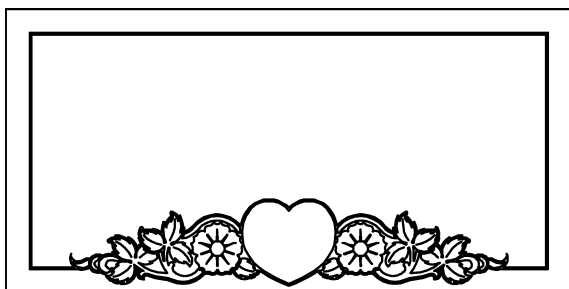

AG-M-415

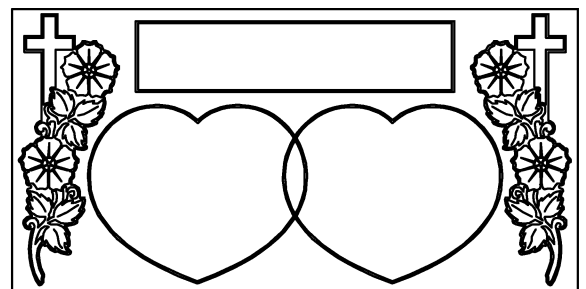

AG-M-416

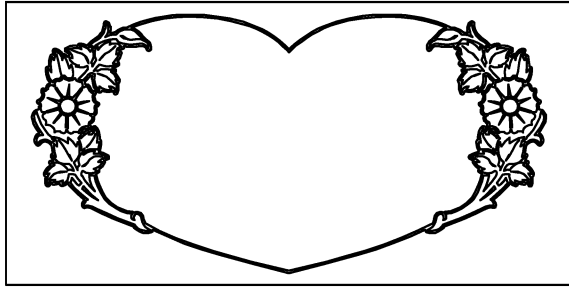

AG-M-417

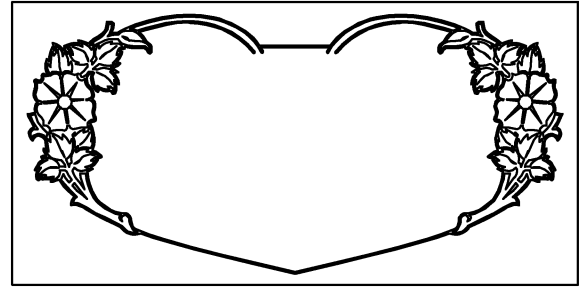

AG-M-418

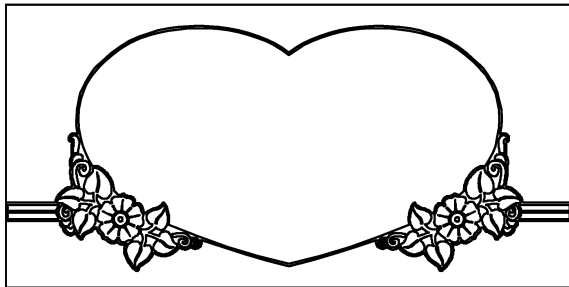

AG-M-419

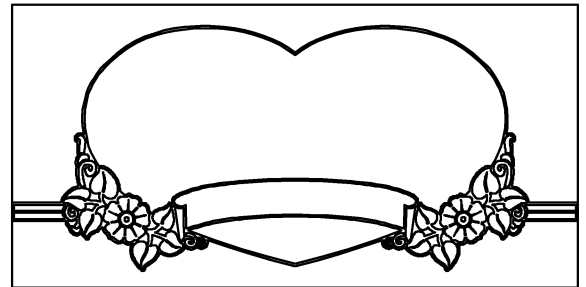

AG-M-420

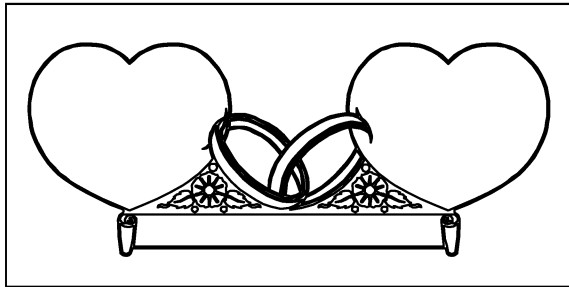

AG-M-421

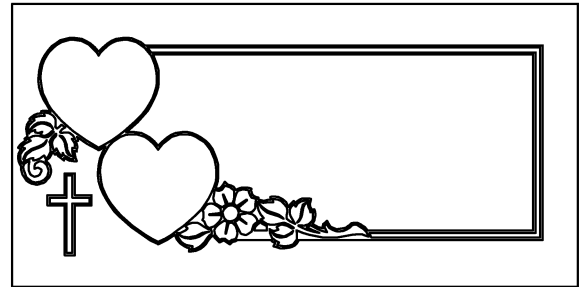

AG-M-422

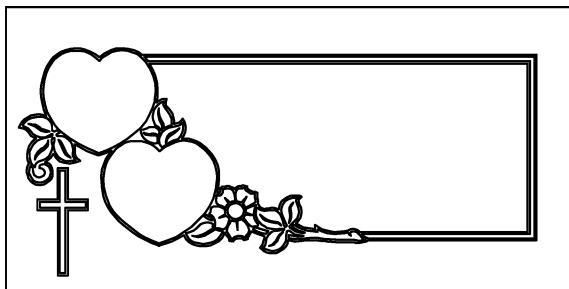

AG-M-423

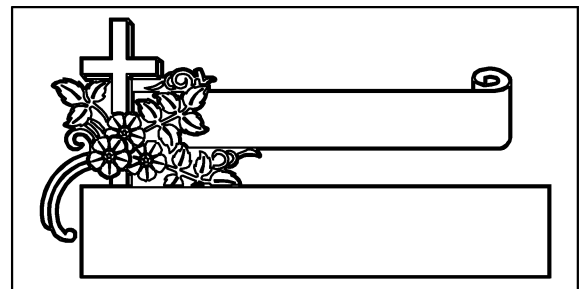

AG-M-424



Components



ANGEL 01 7x5

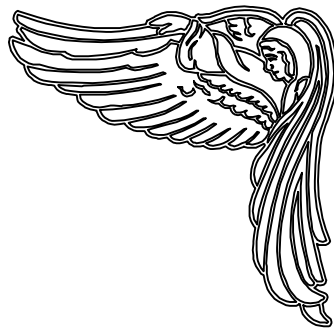

ANGEL 02 8x8



ANGEL 03 6x9



ANGEL 04 5x6



ANGEL 05 5x9

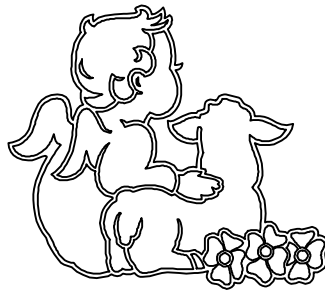

ANGEL 06 5x5



ANGEL 07 8x6



ANGEL 08 5x6



ANGEL 09 6x10



ANGEL 10 5x7



ANGEL 11 6x10



ANGEL 12 10x11



ANGEL 13 8x12



ANGEL 14 7x10



ANGEL 15 6x11



ANGEL 16 9x9



ANGEL 17 8x13



ANGEL 18 12x18



ANGEL 19 5x10



ANGEL 20 10x14



ANGEL 21 6x11



ANGEL 22 13x19



ANGEL 23 11x5



ANGEL 24 6x10



ANGEL 25 7x12

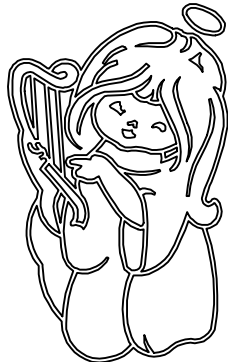

ANGEL 26 4x7



ANGEL 27 8x3



ANGEL 28 4x9



ANGEL 29 4x7



ANGEL 30 5x3



ANGEL 31 11x6

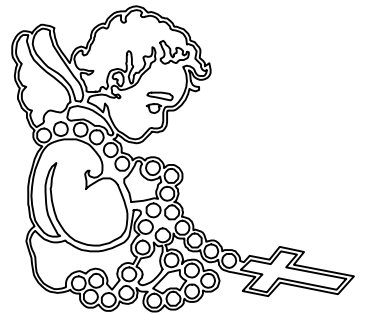

ANGEL 32 8x7



ANGEL 33 3x5



ANGEL 34 10x14



ANGEL 35 22x18



ANGEL 36 3x7



ANGEL 37 17x13



ANGEL 38 8x7

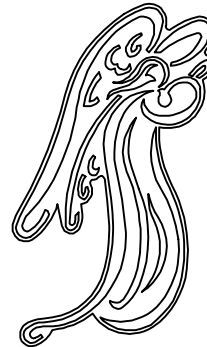

ANGEL 39 7x12



ANGEL 40 10x11



ANGEL 41 5x7



ANGEL 42 6x8



ANGEL 43 8x11



ANGEL 44 8x12



ANGEL 45 7x9



ANGEL 46 6x8

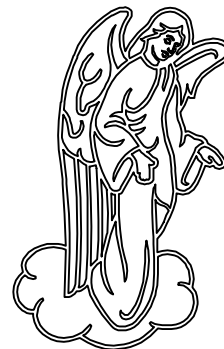

ANGEL 47 4x7



ANGEL 48 8x13



ANGEL 49 5x9



ANGEL 50 5x8



ANGEL 51 4x7



ANGEL 52 8x9



ANGEL 53 3x8



ANGEL 54 5x7



ANGEL 55 3x4



ANGEL 56 6x8



ANGEL 57 4x7



ANGEL 58 4x8



ANGEL 59 6x7



ANGEL 60 5x5



ANGEL 61 6x10



ANGEL 62 4x5



ANGEL 63 8x13



ANGEL 64 4x7



BIRD 01 4X5

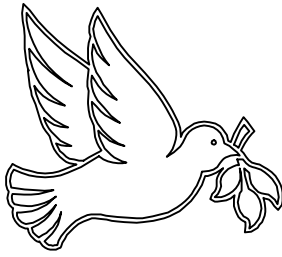

BIRD 02 5X4

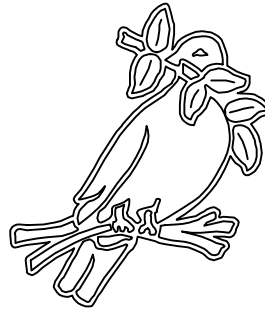

BIRD 03 5X5

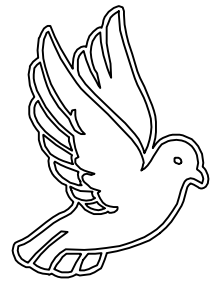

BIRD 04 4X5



BIRD 05 6X4



BIRD06 9X8



BIRD 07 15X5



BIRD 08 7X6

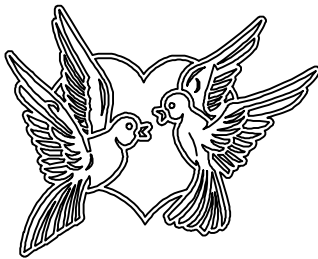

BIRD 09 6X5

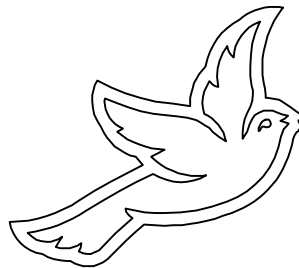

BIRD 10 2X2



BIRD 11 2X2



BIRD 12 16X5

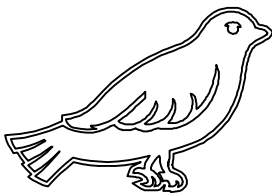

BIRD 13 5X4



BIRD 14 5X7



BIRD 15 6X9

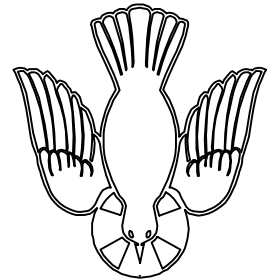

BIRD 16 6X7

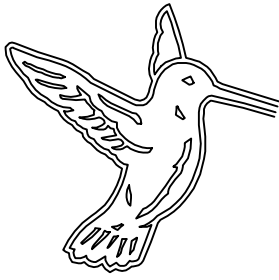

BIRD 1 4X5



BIRD 2 5X4

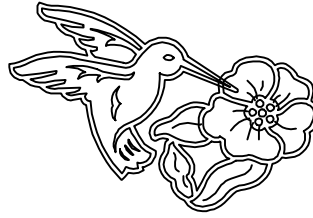

BIRD 3 5X5

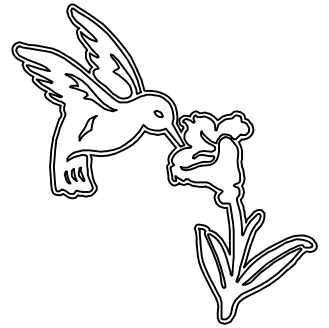

BIRD 4 4X5

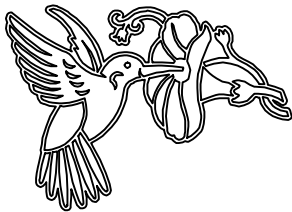

BIRD 5 6X4



BIRD 6 9X8



BIRD 7 15X5

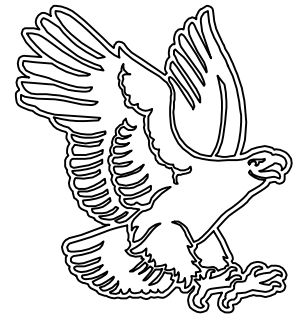

BIRD 8 7X6

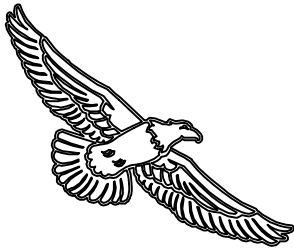

BIRD 09 6X5

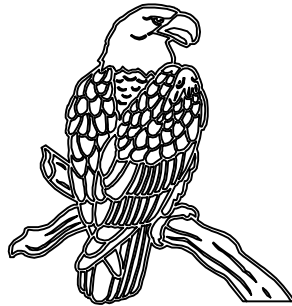

BIRD 10 2X2

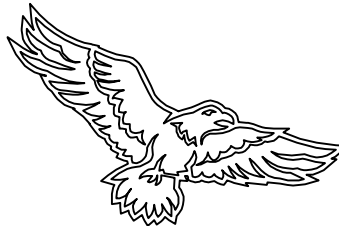

BIRD 11 2X2



BIRD 12 16X5

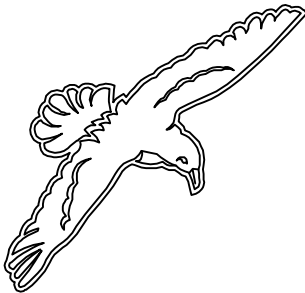

BIRD 13 5X4

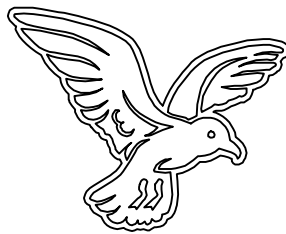

BIRD 14 5X7



BIRD 15 6X9



BIRD 16 6X7

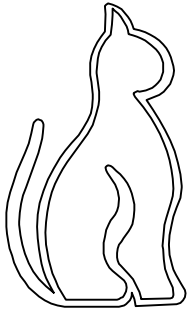

CAT 33 3X5



CAT 34 5X7

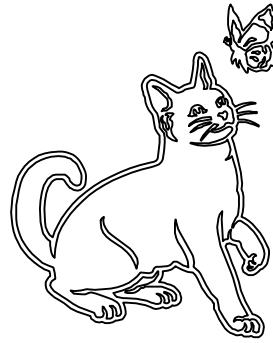

CAT 35 18X7

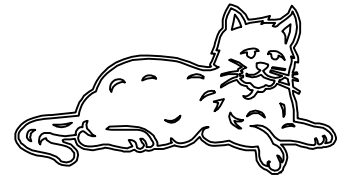

CAT 36 7 X 4

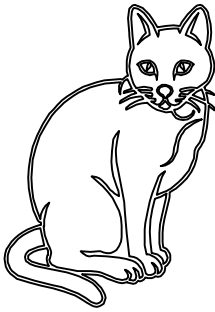

CAT 37 6X9

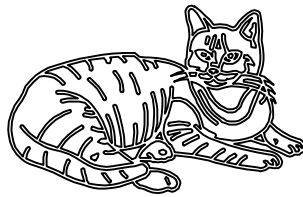

CAT 38 8X5



CAT 39 5X6

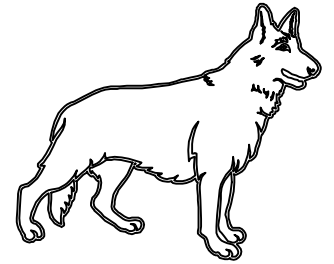

CAT 40 10X8

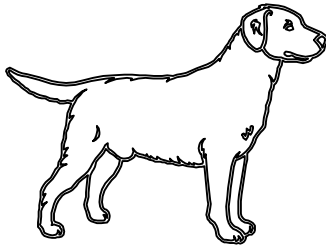

DOG 41 10X8

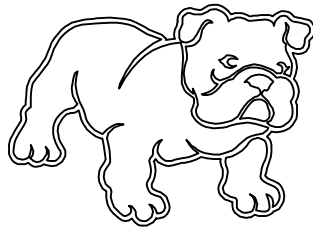

DOG 42 6X4

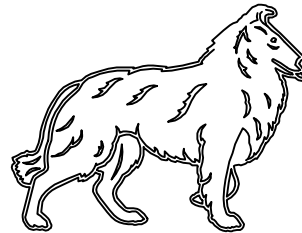

DOG 43 8X6

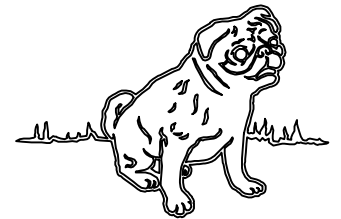

DOG 44 4X4

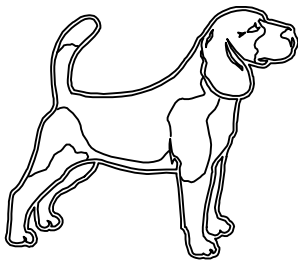

DOG 45 6X4

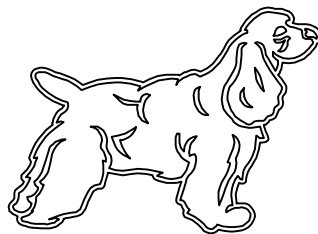

DOG 46 4X4



DOG 47 14X6



DOG 48 6X6



ANIMALS 49 6X5

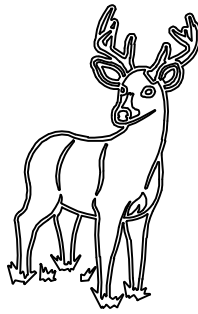

ANIMALS 50 5X8

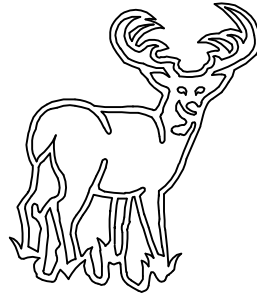

ANIMALS 51 4X4

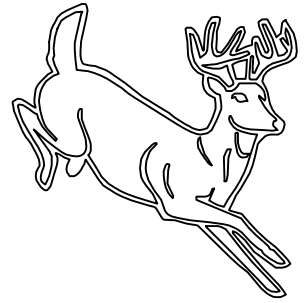

ANIMALS 52 5X5

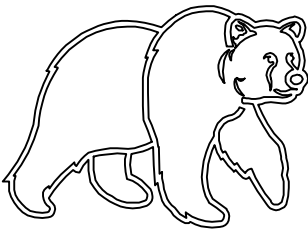

ANIMALS 53 6X4

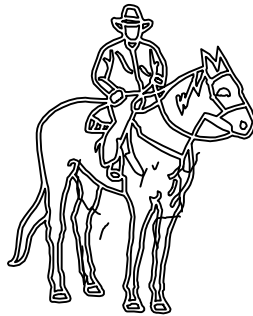

ANIMALS 54 6X8

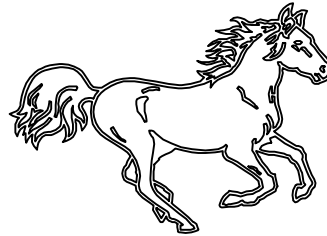

ANIMALS 55 10X7

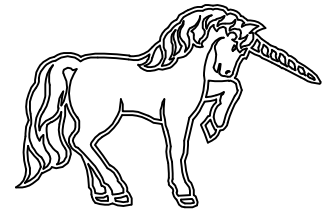

ANIMALS 56 6X4

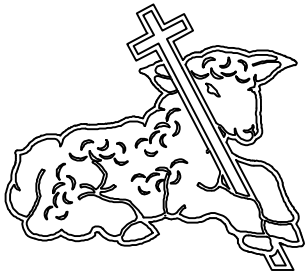

ANIMALS 57 5X4

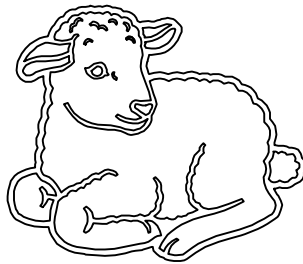

ANIMALS 58 4X4

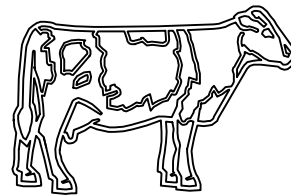

ANIMALS 59 6X4

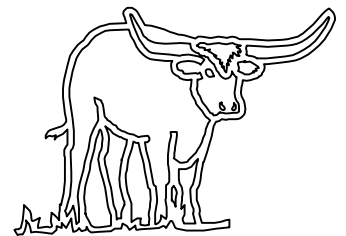

ANIMALS 60 5X4

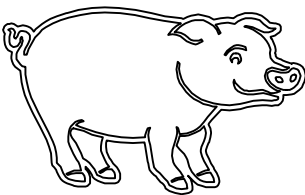

ANIMALS 61 5X3

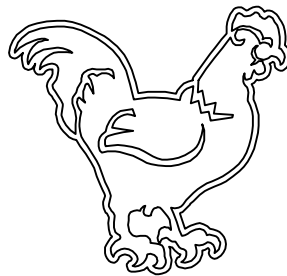

ANIMALS 62 4X4

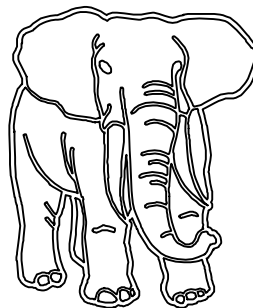

ANIMALS 63 5X5

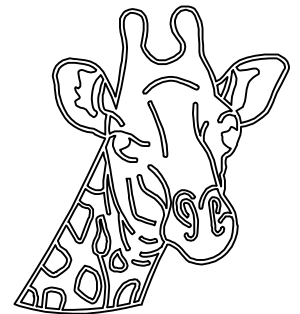

ANIMALS 64 5X6

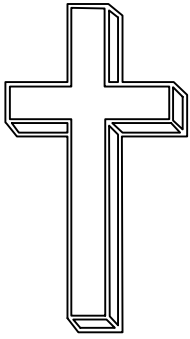

CROSS 01 4X7

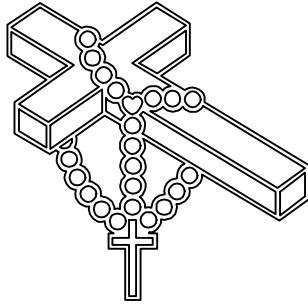

CROSS 02 6X6

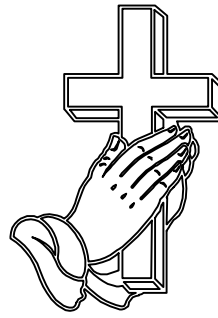

CROSS 03 5X7

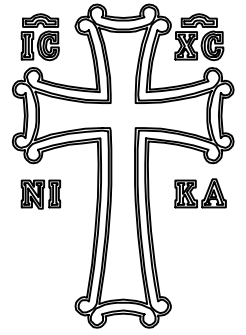

CROSS 04 8X11

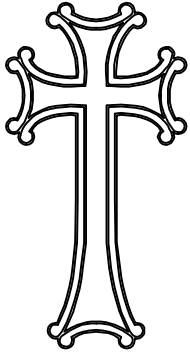

CROSS 05 10X19

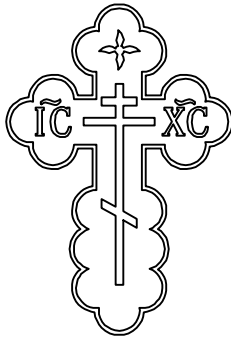

CROSS 06 5X7

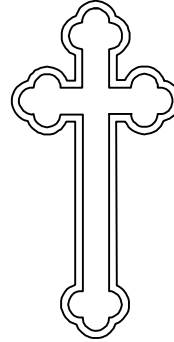

CROSS 07 2X4

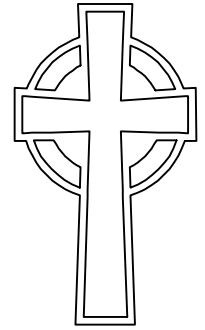

CROSS 08 1X3



CROSS 09 6X9



CROSS 10 5X9



CROSS 11 5X8



CROSS 12 6X10



CROSS 13 10X17



CROSS 14 9X16



CROSS 15 5X9



CROSS 16 6X10

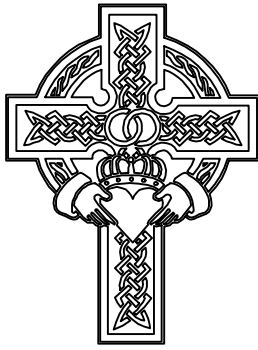

CROSS 17 9X13



CROSS 18 6X10



CROSS 19 7X11



CROSS 20 9X14



CROSS 21 6X9



CROSS 22 9X18



CROSS 23 8X16



CROSS 24 8X12



CROSS 25 10X15



CROSS 26 5X11

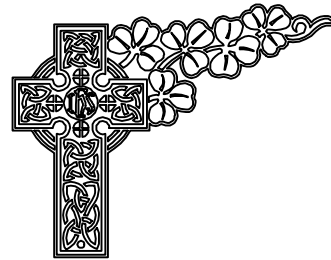

CROSS 27 12X9



CROSS 28 18X31



CROSS 29 4X6



CROSS 30 7X14

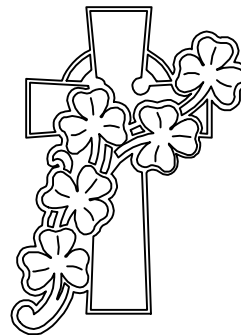

CROSS 31 4X6



CROSS 32 14X8

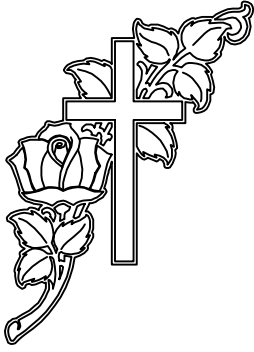

CROSS 33 7X9

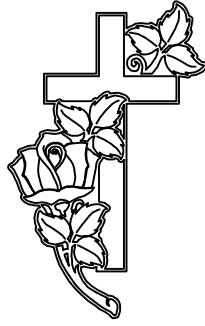

CROSS 34 6X10

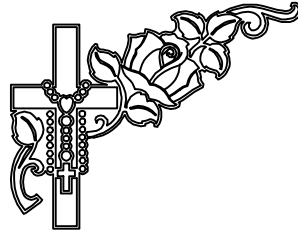

CROSS 35 10X8

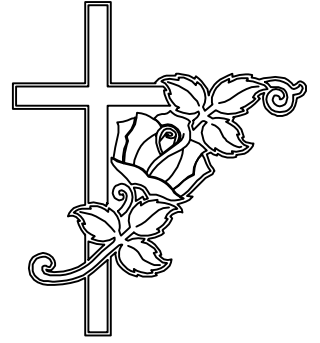

CROSS 36 8X9



CROSS 37 6X11

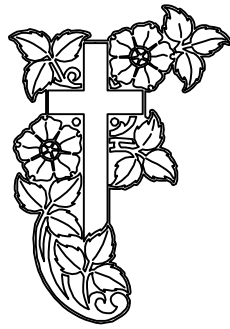

CROSS 38 9X13

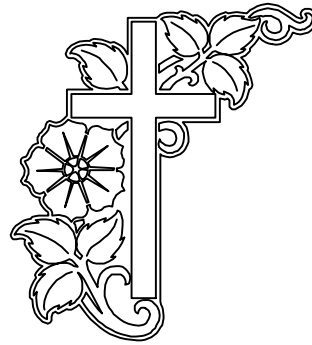

CROSS 39 6X7

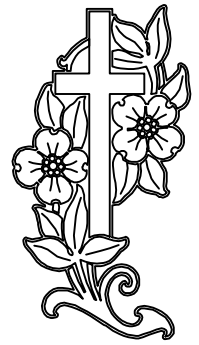

CROSS 40 6X12

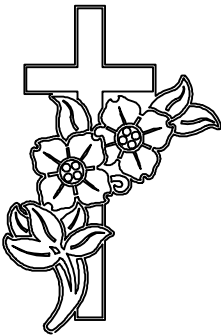

CROSS 41 7X10

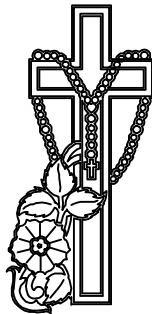

CROSS 42 6X12



CROSS 43 15X5

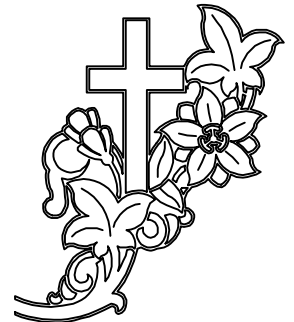

CROSS 44 9X11

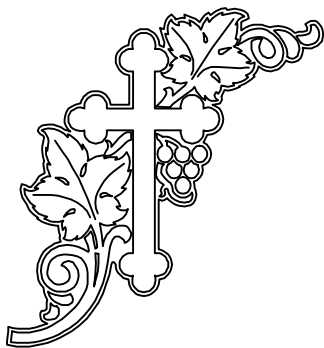

CROSS 45 7X7



CROSS 46 7X11

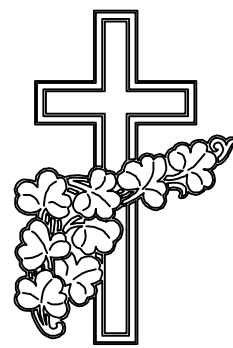

CROSS 47 9X13



CROSS 48 5X11

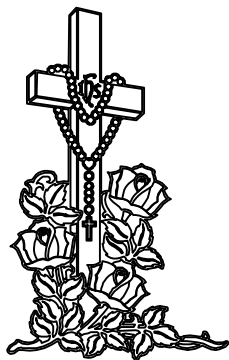

CROSS 49 11X17

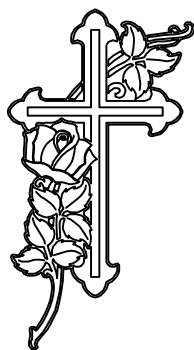

CROSS 50 8X15

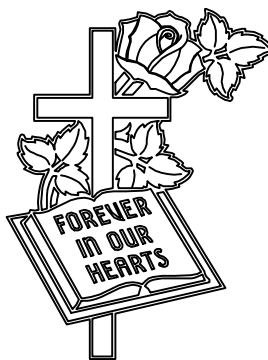

CROSS 51 8X11

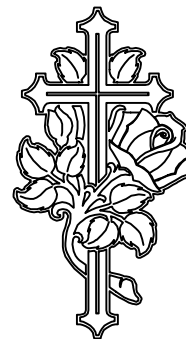

CROSS 52 6X11

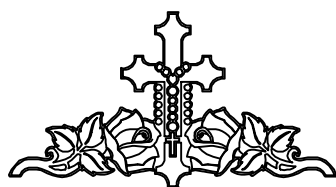

CROSS 53 17X9



CROSS 54 6X14

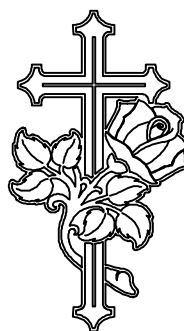

CROSS 55 6X10



CROSS 56 10X19



CROSS 57 8X11

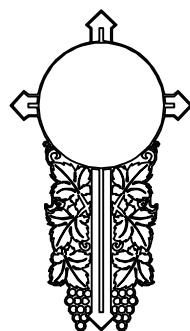

CROSS 58 12X20



CROSS 59 20X16

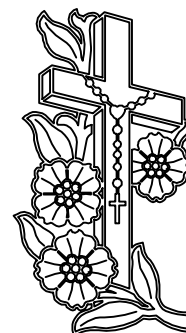

CROSS 60 6X10

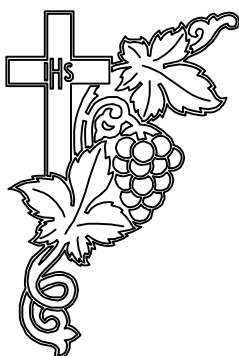

CROSS 61 8X12

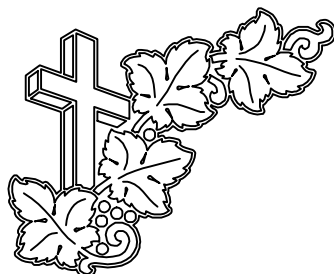

CROSS 62 9X8



CROSS 63 6X12

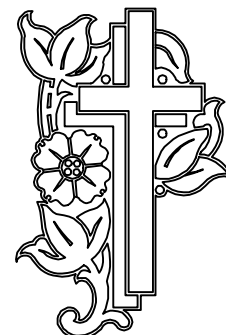

CROSS 64 7X10

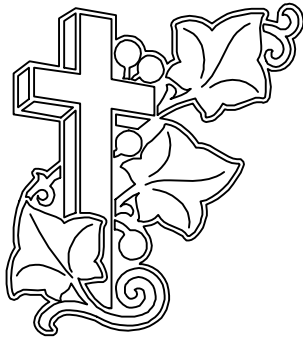

CROSS 65 5X6

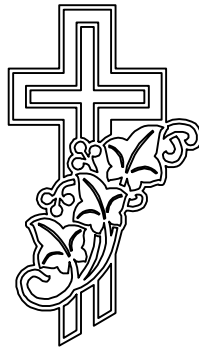

CROSS 66 4X7

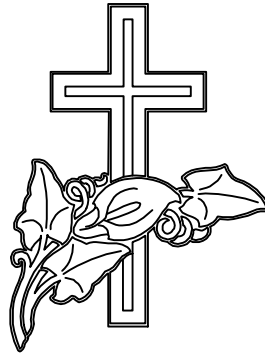

CROSS 67 10X13



CROSS 68 8X23

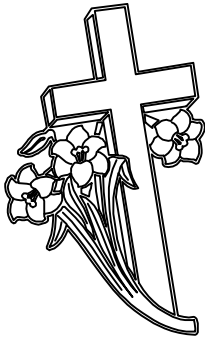

CROSS 69 7X11

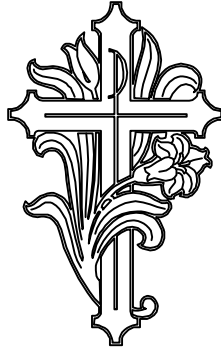

CROSS 70 8X12

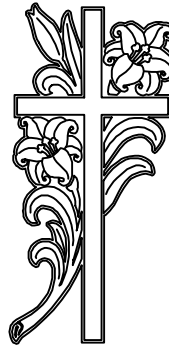

CROSS 71 6X12



CROSS 72 6X10



CROSS 73 8X16



CROSS 74 11X6

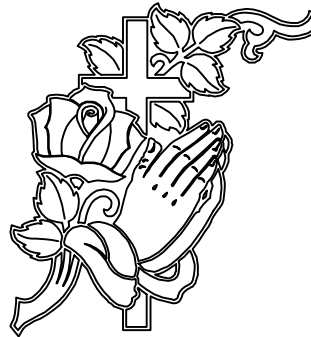

CROSS 75 8X9



CROSS 76 5X10



CROSS 77 4X8

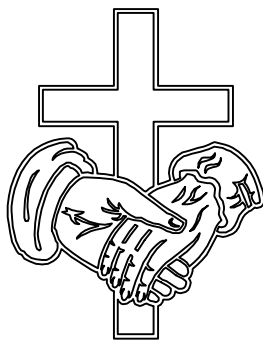

CROSS 14 9X16



CROSS 15 5X9



CROSS 80 4X6

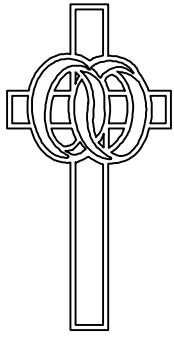

CROSS 81 3X6

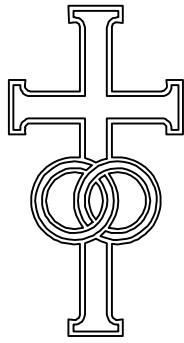

CROSS 22 3X6

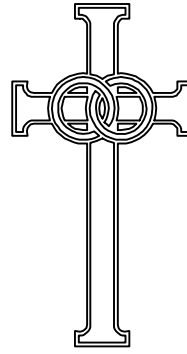

CROSS 83 4X8

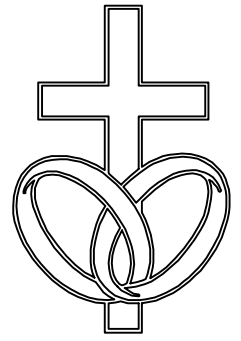

CROSS 84 6X9

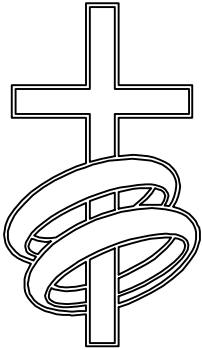

CROSS 85 5X8

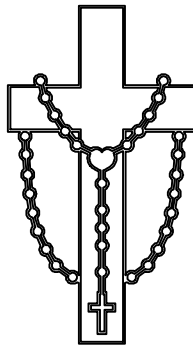

CROSS 86 5X10

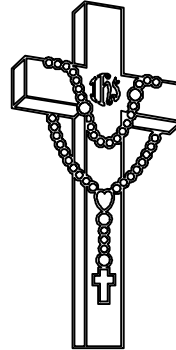

CROSS 87 6X12

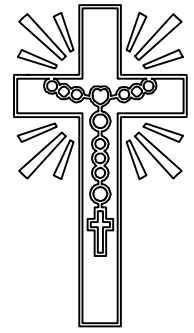

CROSS 88 5X10

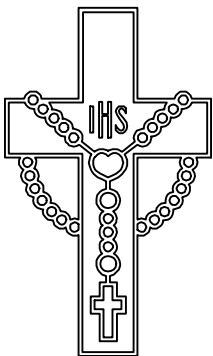

CROSS 89 5X8

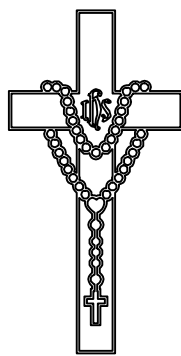

CROSS 90 6X12

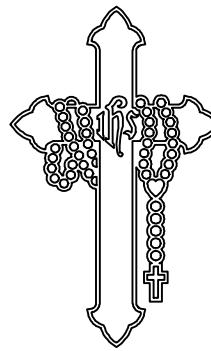

CROSS 91 5X9

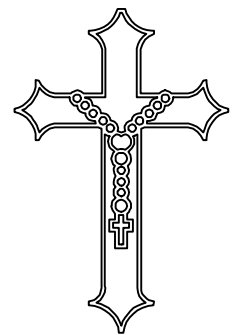

CROSS 92 4X7

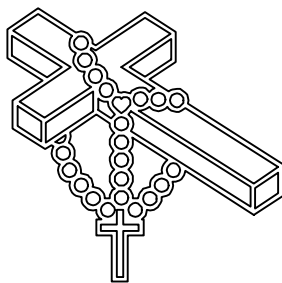

CROSS 93 5X5

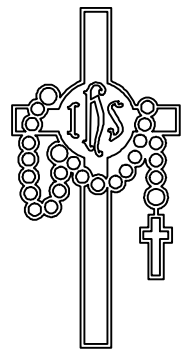

CROSS 94 4X7



CROSS 95 4X7

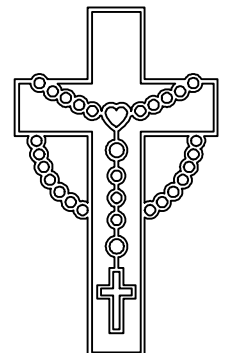

CROSS 96 4X6

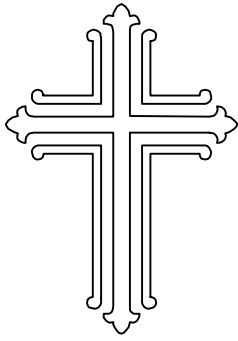

CROSS 97 3X4

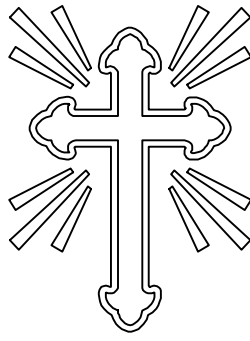

CROSS 98 3X4

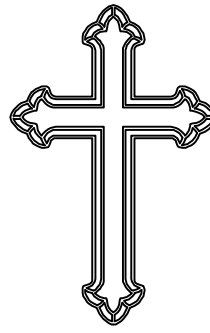

CROSS 99 7X10

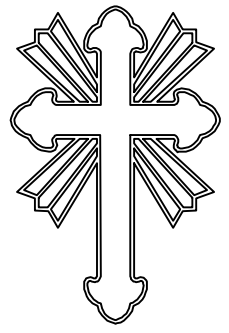

CROSS 100 5X7

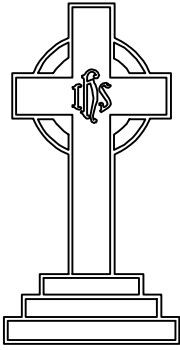

CROSS 101 4X8

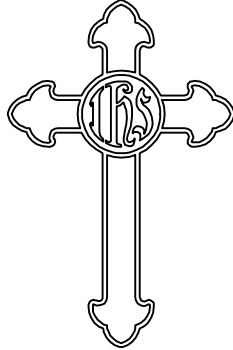

CROSS 102 5X7



CROSS 103 6X9

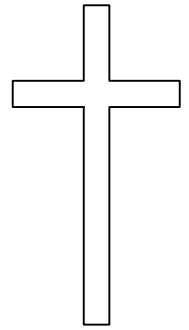

CROSS 104 4X7

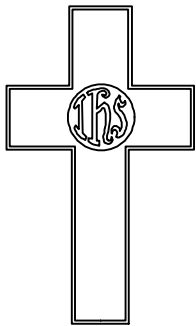

CROSS 105 4X6

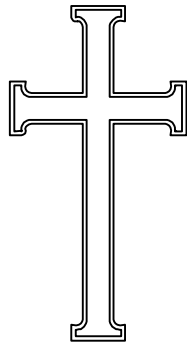

CROSS 106 4X7

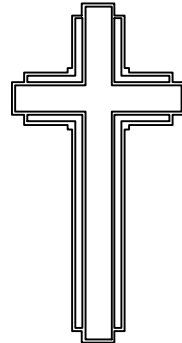

CROSS 107 5X10

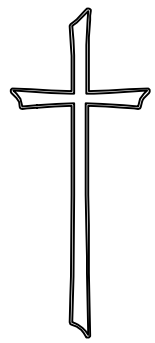

CROSS 108 5X10

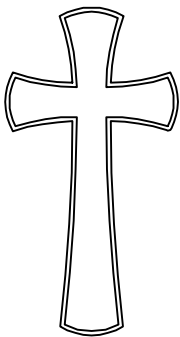

CROSS 109 3X6

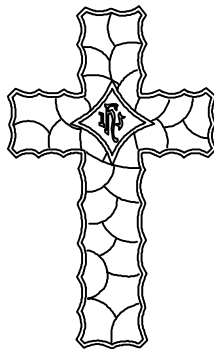

CROSS 110 5X8



CROSS 111 9X17

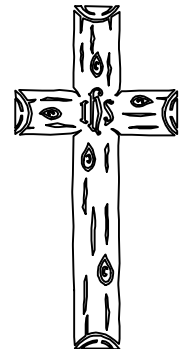

CROSS 112 6X14

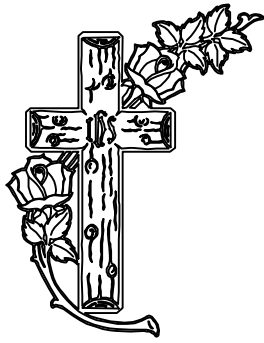

CROSS 113 11X15

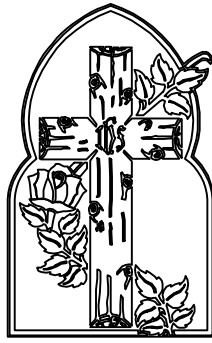

CROSS 114 10X17

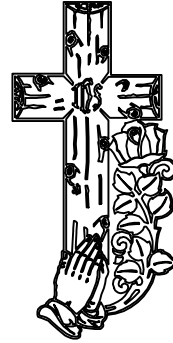

CROSS 115 9X19

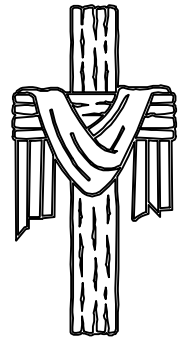

CROSS 116 7X4

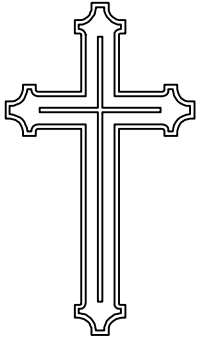

CROSS 117 4X7

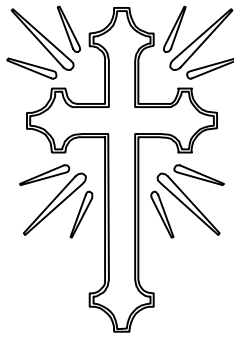

CROSS 118 5X7

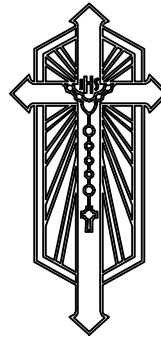

CROSS 119 6X12

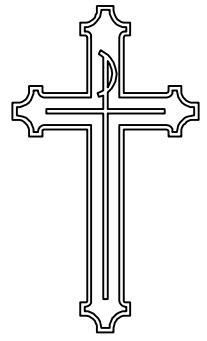

CROSS 120 4X7

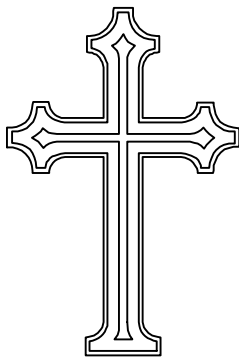

CROSS 121 5X8

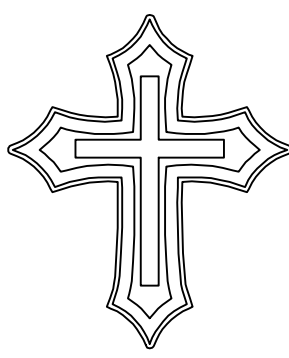

CROSS 122 6X7

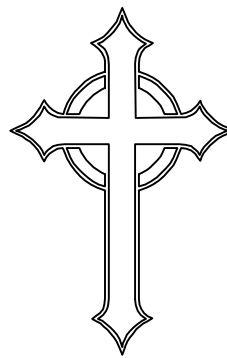

CROSS 123 6X9

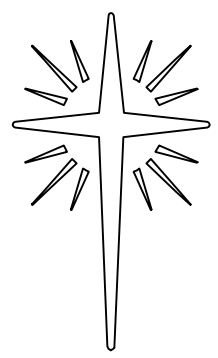

CROSS 124 3X5

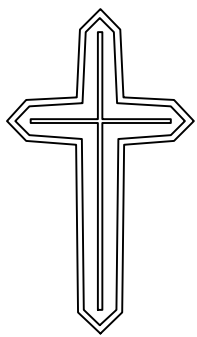

CROSS 125 2X4

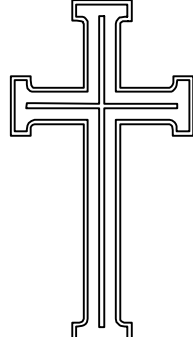

CROSS 126 4X7

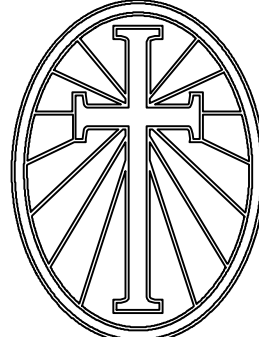

CROSS 127 7X10

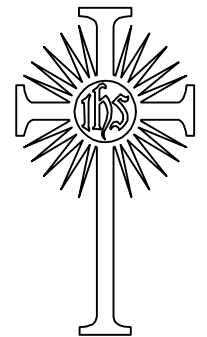

CROSS 128 2X4

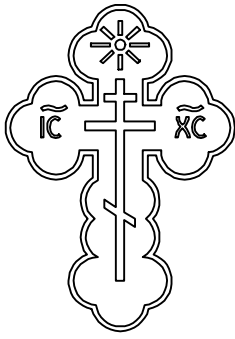

CROSS 129 4X6

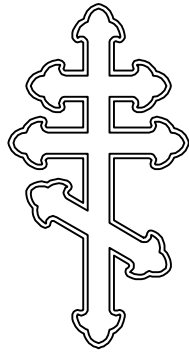

CROSS 130 4X7

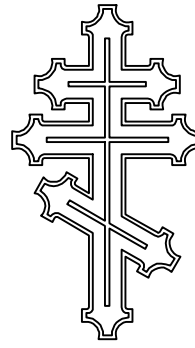

CROSS 131 4X8

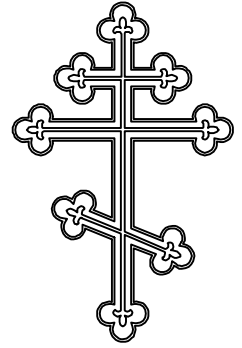

CROSS 132 7X10

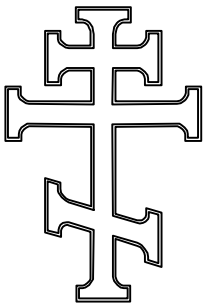

CROSS 133 4X6

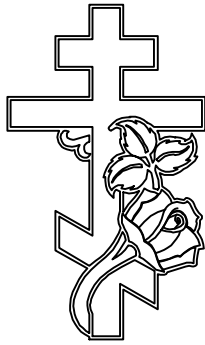

CROSS 134 5X9

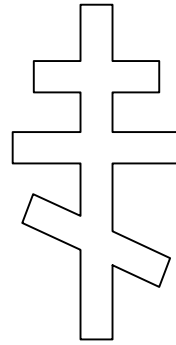

CROSS 135 1X2

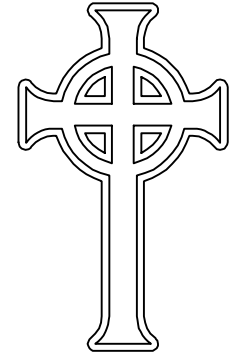

CROSS 136 2X4

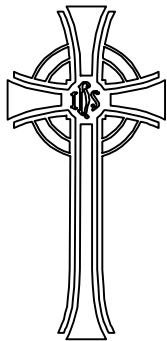

CROSS 137 6X12



CROSS 138 12X35

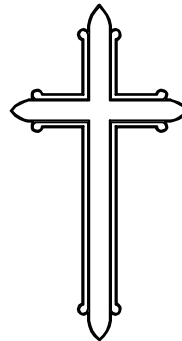

CROSS 139 13X25

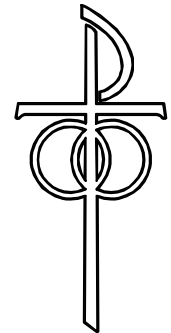

CROSS 140 12X27

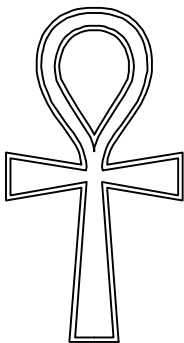

CROSS 141 3X6

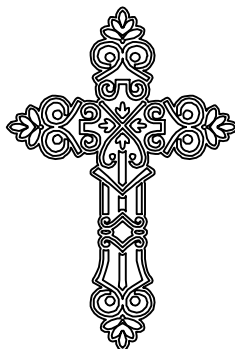

CROSS 142 7X10



CROSS 143 6X10

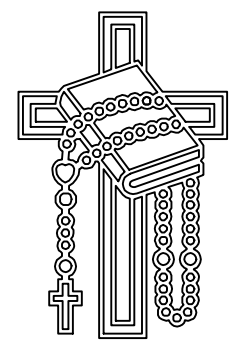

CROSS 144 4X6



CROSS 145 5X5

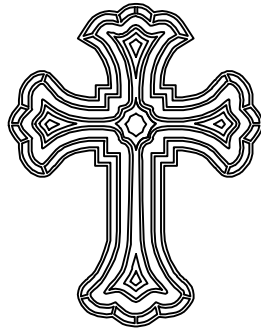

CROSS 146 7X9

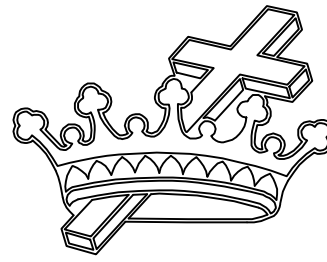

CROSS 147 8X6

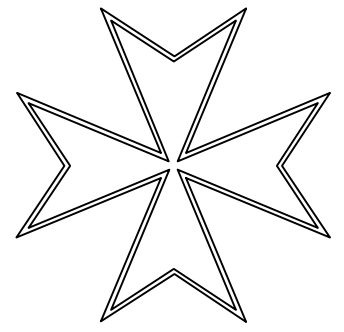

CROSS 148 6X6

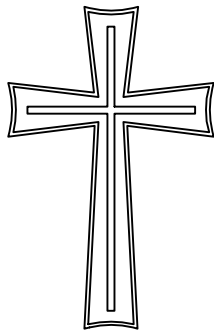

CROSS 149 5X8

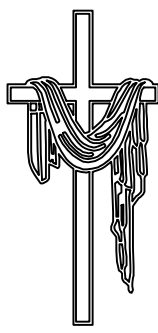

CROSS 150 4X9

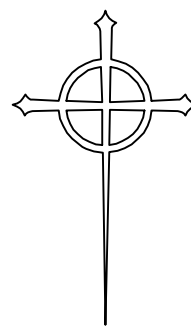

CROSS 151 5X8

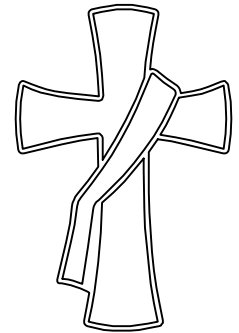

CROSS 152 4X6

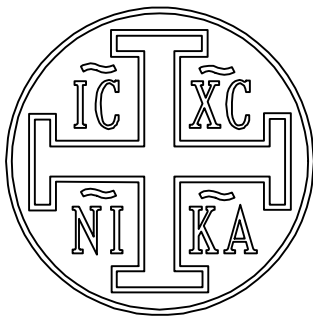

CROSS 153 5X5

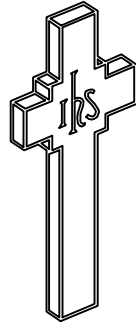

CROSS 154 4X9



CROSS 155 5X9

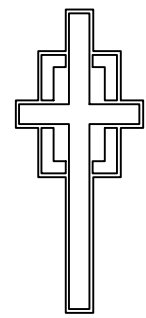

CROSS 156 3X8

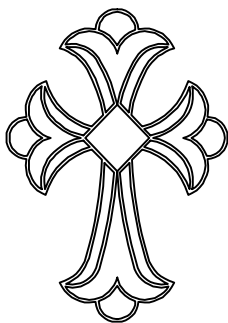

CROSS 157 10X14

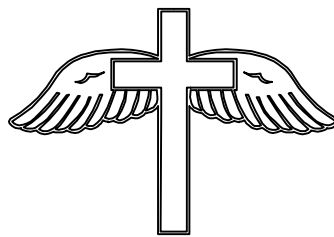

CROSS 158 10X7

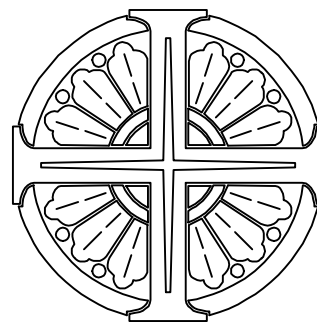

CROSS 159 13X13

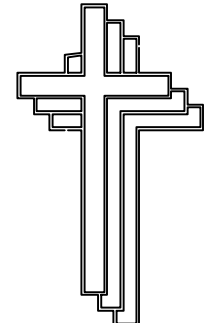

CROSS 160 6X10

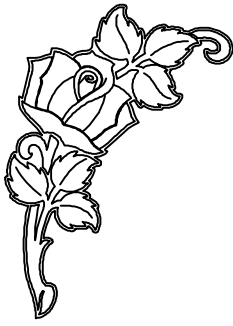

FLORAL 1 7X9

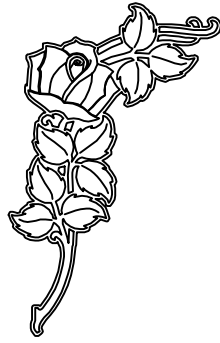

FLORAL 2 6X9



FLORAL 3 5X10



FLORAL 4 5X10

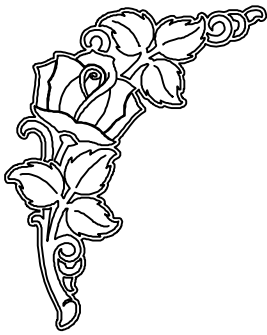

FLORAL 5 6X8



FLORAL 6 4X10



FLORAL 7 8X9

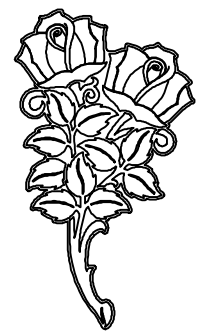

FLORAL 8 7X12

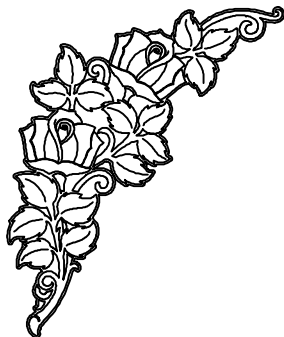

FLORAL 9 12X14

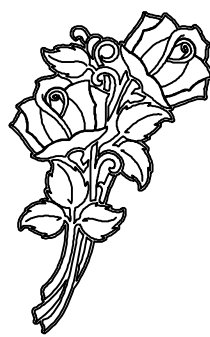

FLORAL 10 8X12



FLORAL 11 7X10

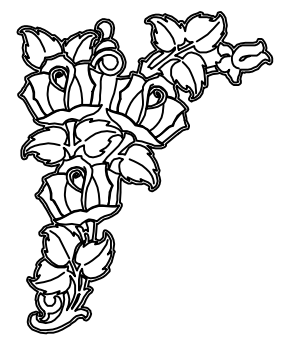

FLORAL 12 9X11

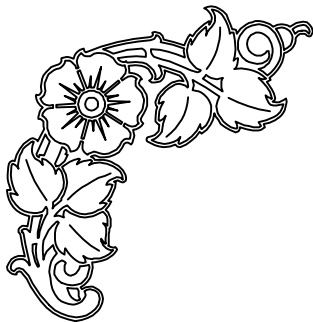

FLORAL 13 7X7

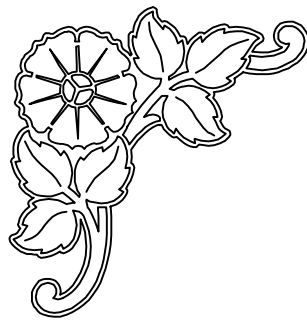

FLORAL 14 6X6

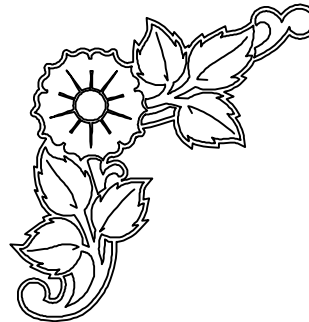

FLORAL 15 7X7

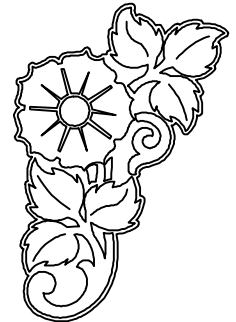

FLORAL 16 5X8

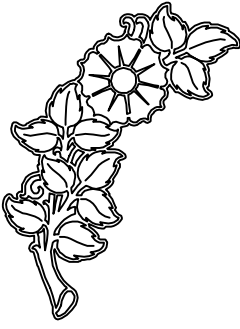

FLORAL 17 7X9

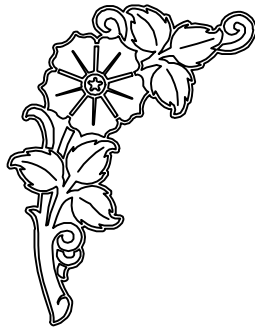

FLORAL 18 6X8



FLORAL 19 3X8

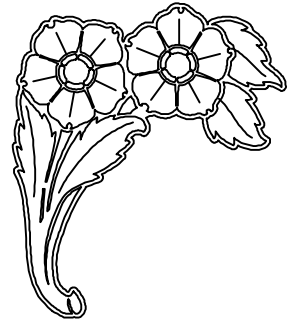

FLORAL 20 5X6



FLORAL 21 8X11

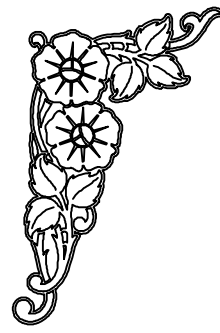

FLORAL 22 7X11

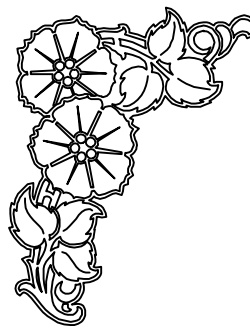

FLORAL 23 6X8

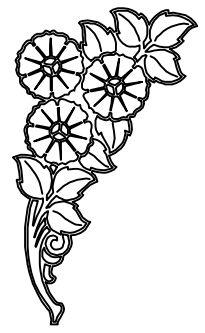

FLORAL 24 7X12

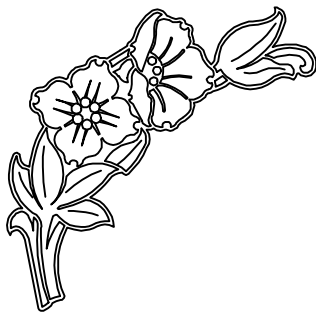

FLORAL 25 6X6

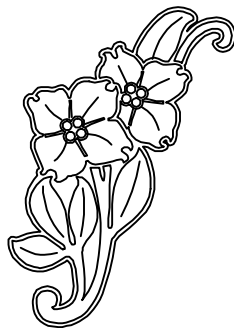

FLORAL 26 5X7

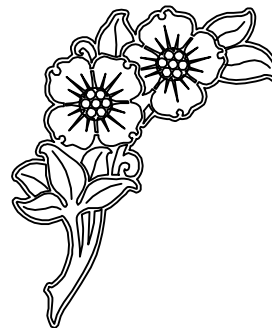

FLORAL 27 6X8

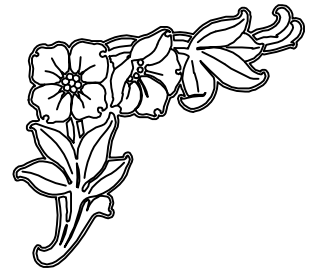

FLORAL 28 9X8

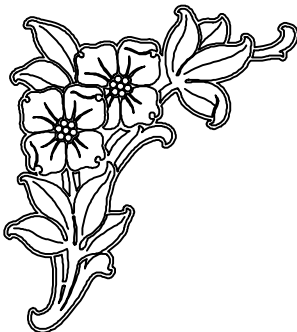

FLORAL 29 8X9



FLORAL 30 8X9

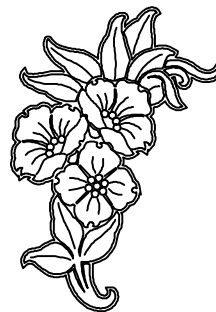

FLORAL 31 7X9



FLORAL 32 8X9

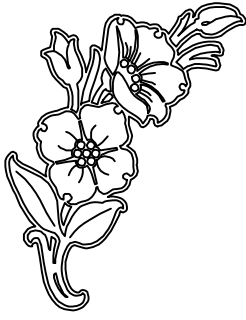

FLORAL 33 6X8



FLORAL 34 8X12



FLORAL 35 5X10

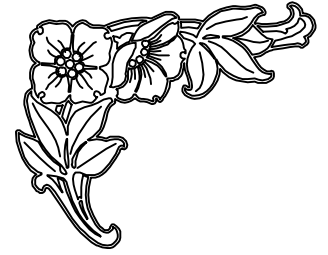

FLORAL 36 10X8

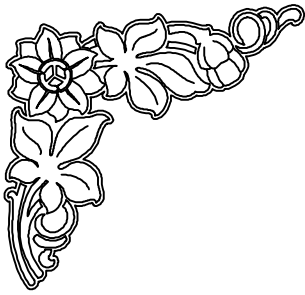

FLORAL 37 8X8

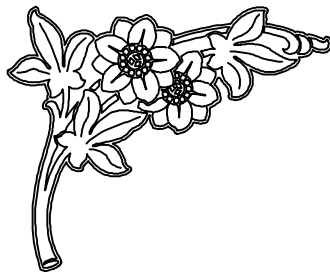

FLORAL 38 10X8



FLORAL 39 8X10

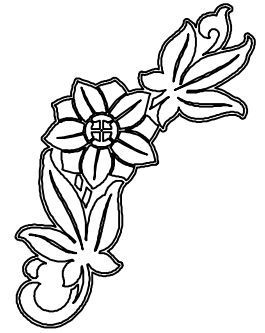

FLORAL 40 7X10

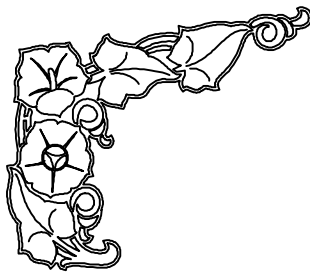

FLORAL 41 8X7

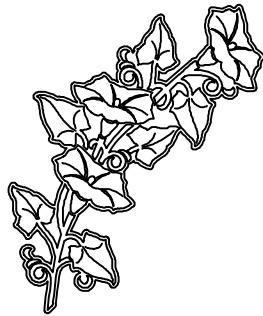

FLORAL 42 7X9



FLORAL 43 5X9

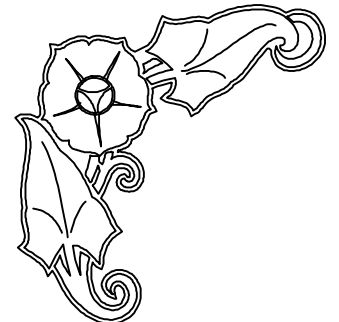

FLORAL 44 6X6

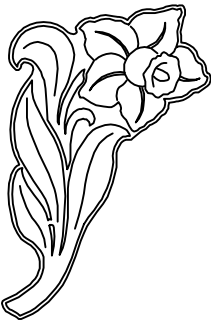

FLORAL 45 5X8

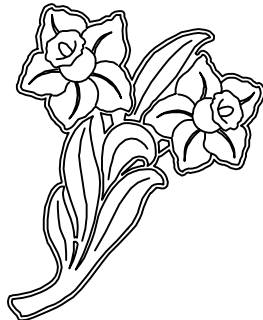

FLORAL 46 6X7



FLORAL 47 6X12



FLORAL 48 6X11

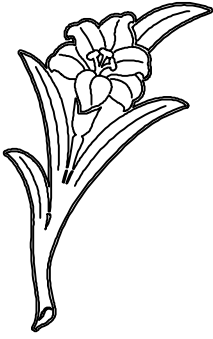

FLORAL 49 8X13

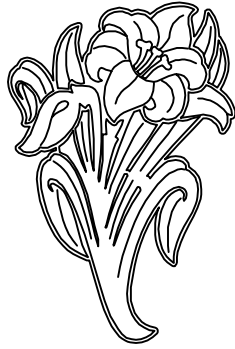

FLORAL 50 5X8



FLORAL 51 4X11



FLORAL 52 8X9

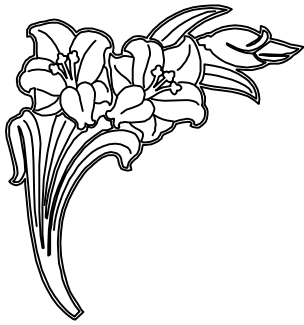

FLORAL 53 9X9



FLORAL 54 8X14



FLORAL 55 8X12

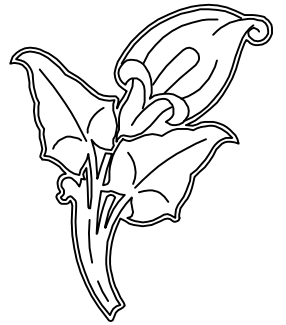

FLORAL 56 5X6



FLORAL 57 5X10



FLORAL 58 10X8

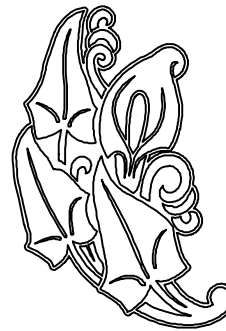

FLORAL 59 6X9

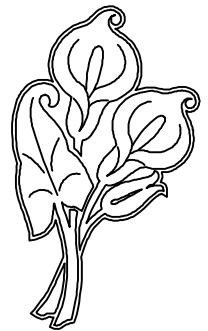

FLORAL 60 5X8



FLORAL 61 17X20

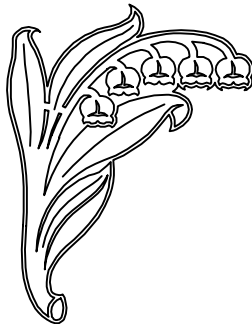

FLORAL 62 6X8



FLORAL 63 7X10



FLORAL 64 4X8

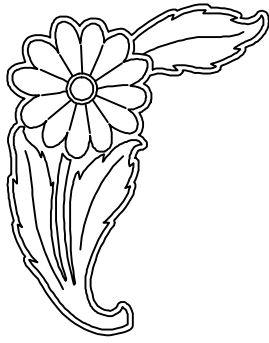

FLORAL 65 4X6

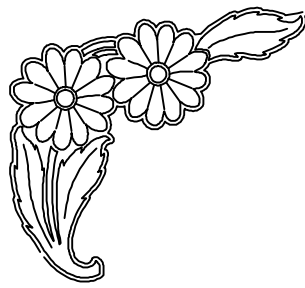

FLORAL 66 7X6



FLORAL 67 6X9

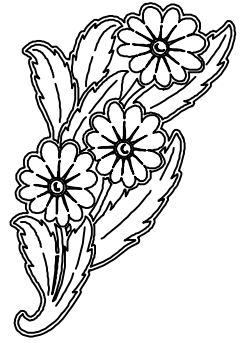

FLORAL 68 6X8

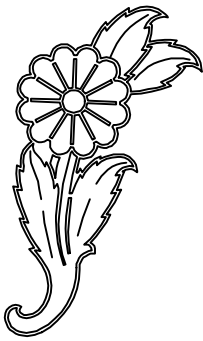

FLORAL 69 6X9

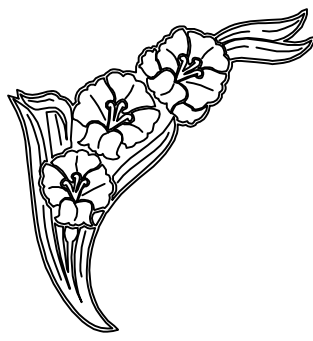

FLORAL 70 8X9



FLORAL 71 4X12

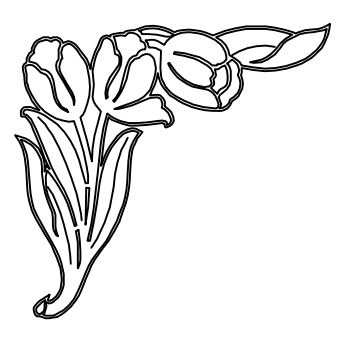

FLORAL 72 10X9

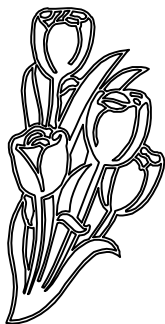

FLORAL 73 5X10



FLORAL 74 16X8



FLORAL 75 4X9

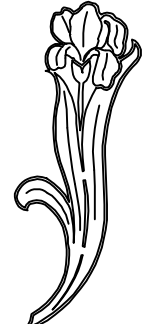

FLORAL 76 4X10



FLORAL 77 5X9

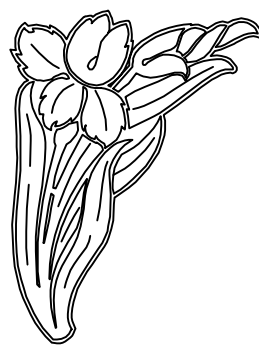

FLORAL 78 6X8



FLORAL 79 4X9



FLORAL 80 3X9



FLORAL 81 5X7

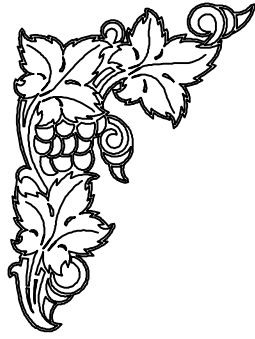

FLORAL 82 9X12



FLORAL 83 8X7



FLORAL 84 7X9

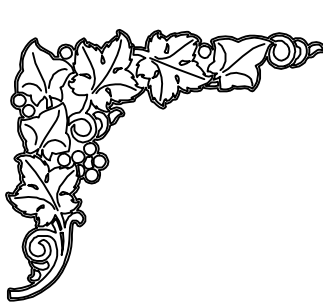

FLORAL 85 12X10



FLORAL 86 7X9



FLORAL 87 7X11

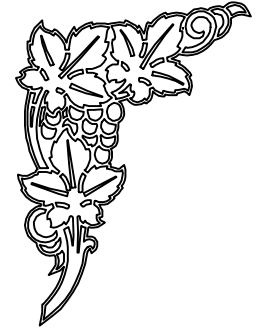

FLORAL 88 5X7



FLORAL 89 10X8

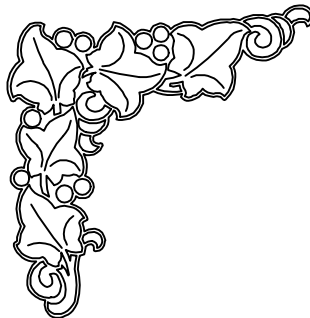

FLORAL 90 7X7

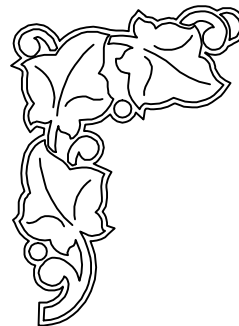

FLORAL 91 4X6



FLORAL 92 10X13

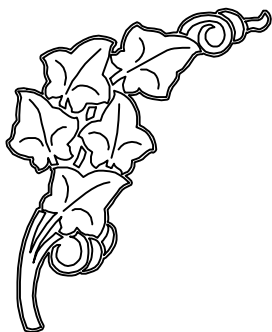

FLORAL 93 9X11

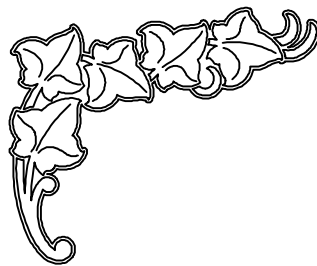

FLORAL 94 9X7



FLORAL 95 11X14



FLORAL 96 4X10

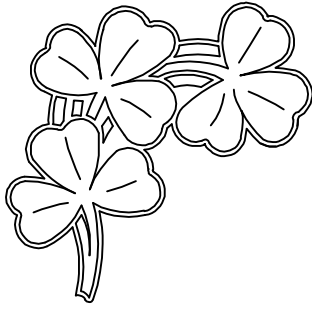

FLORAL 97 6X5

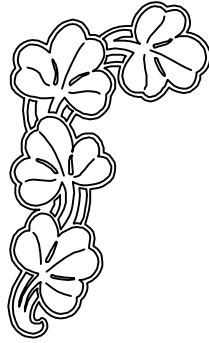

FLORAL 98 4X7

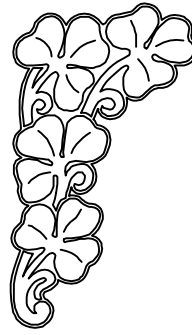

FLORAL 99 6X10

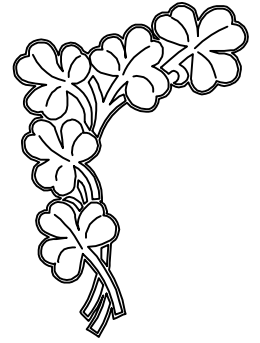

FLORAL 100 7X10

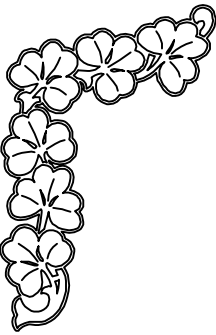

FLORAL 101 7X11

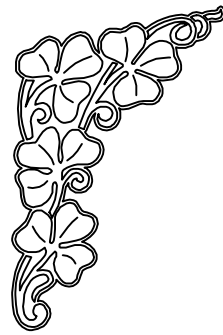

FLORAL 102 6X9

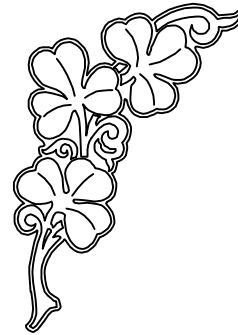

FLORAL 103 6X9

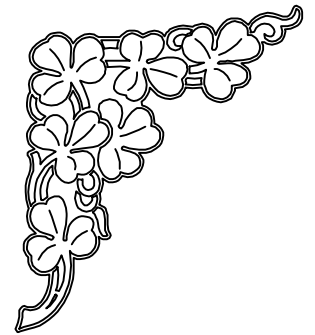

FLORAL 104 7X8

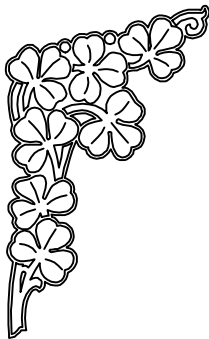

FLORAL 105 6X10



FLORAL 106 9X10

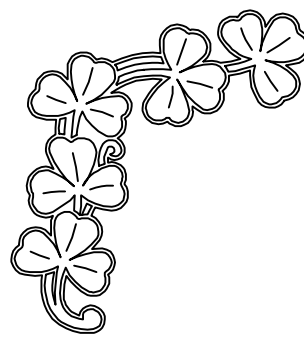

FLORAL 107 7X7

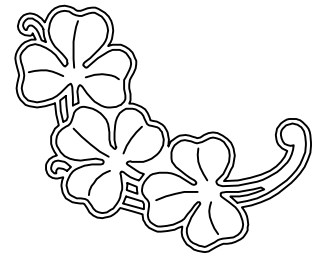

FLORAL 108 5X4

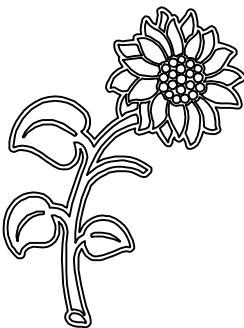

FLORAL 109 5X6

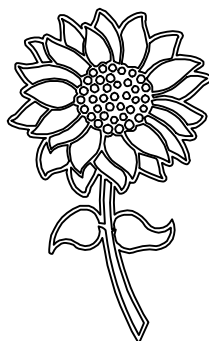

FLORAL 110 4X7



FLORAL 111 6X14



FLORAL 112 7X13



FLORAL 113 3X6

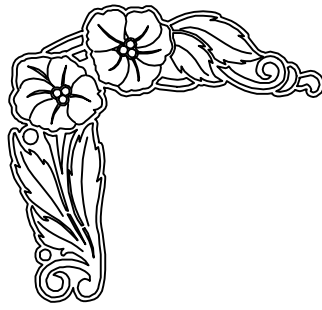

FLORAL 114 6X6

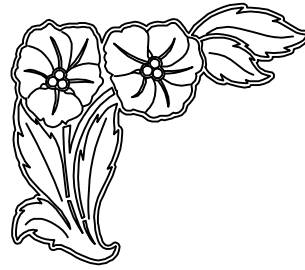

FLORAL 115 7X6



FLORAL 116 3X12

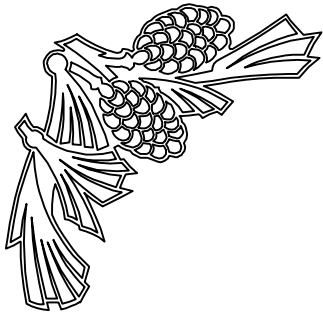

FLORAL 117 7X7

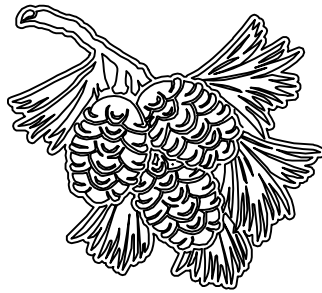

FLORAL 118 6X5

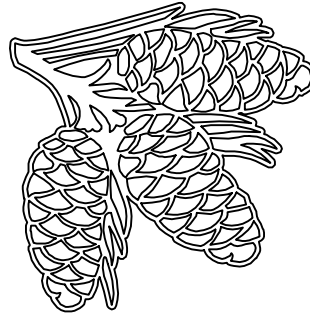

FLORAL 119 6X6

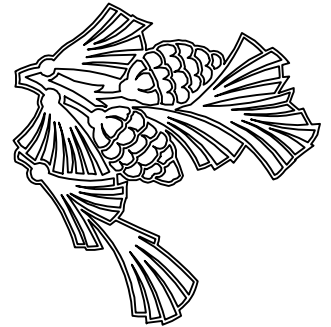

FLORAL 120 6X6

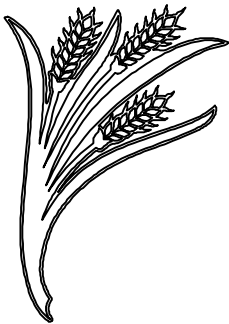

FLORAL 121 6X9



FLORAL 122 5X11



FLORAL 123 6X14



FLORAL 124 10X13



FLORAL 125 7X13



FLORAL 126 5X8



FLORAL 127 7X18



FLORAL 128 5X14



HANDS 1 4X5



HANDS 2 6X8



HANDS 3 4X8



HANDS 4 3X4



HANDS 5 3X8

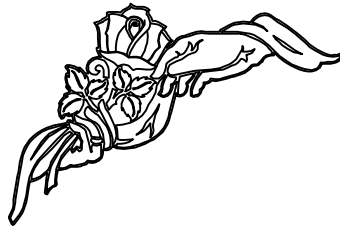

HANDS 6 12X19

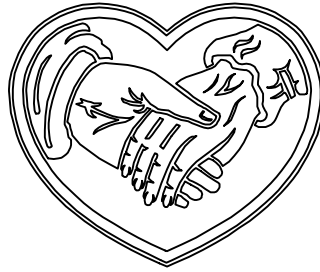

HANDS 7 6X8



HANDS 8 5X7

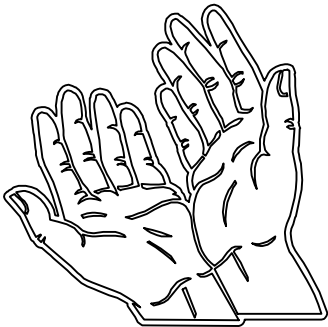

HANDS 9 5X5

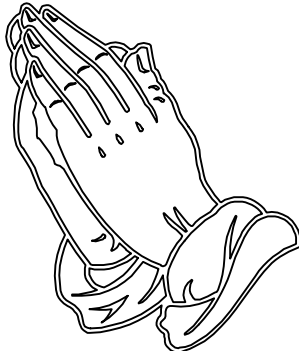

HANDS 10 6X7

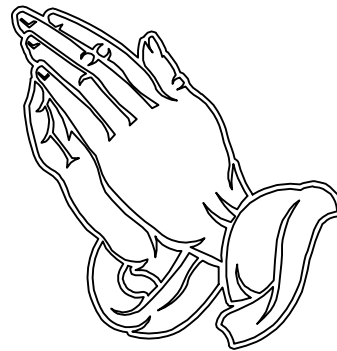

HANDS 11 6X6

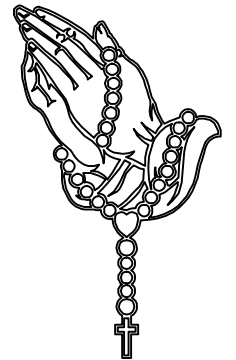

HANDS 12 7X11



HANDS 13 5X8



HANDS 14 6X11



HANDS 15 4X5



HANDS 16 4X6



HANDS 17 4X6



HANDS 18 6X7



HANDS 19 8X8

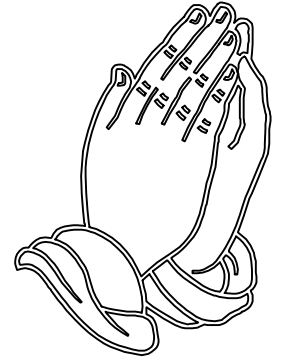

HANDS 20 5X7



HANDS 21 3X3



HANDS 22 4X8

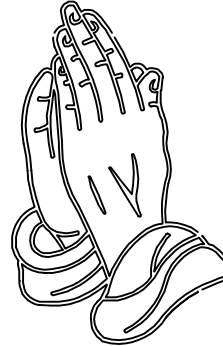

HANDS 23 5X7

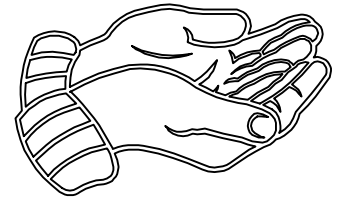

HANDS 24 6X3

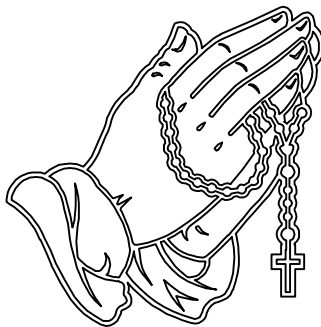

HANDS 25 6X6

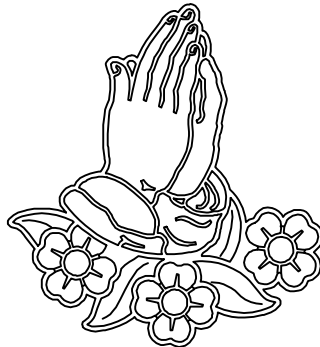

HANDS 26 6X6



HANDS 27 6X6



HANDS 28 4X6



HANDS 29 24X12

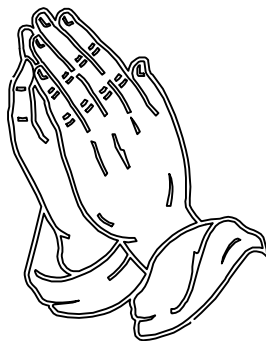

HANDS 30 6X7

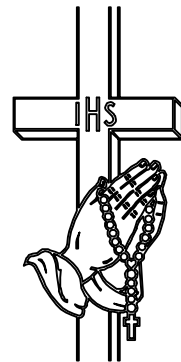

HANDS 31 6X12

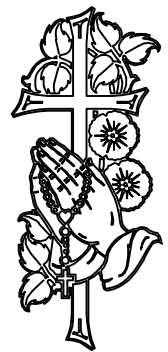

HANDS 32 7X14

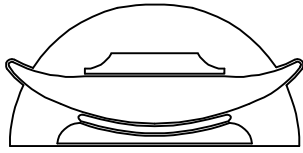

HEBREW 01 9X4

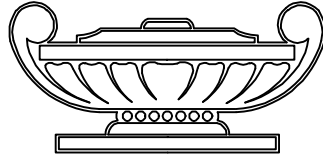

HEBREW 02 8X4

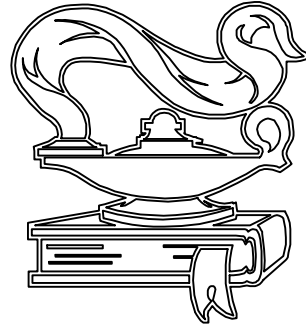

HEBREW 03 6X7

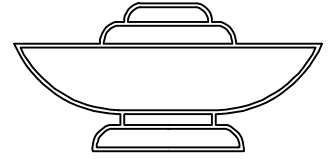

HEBREW 04 6X3

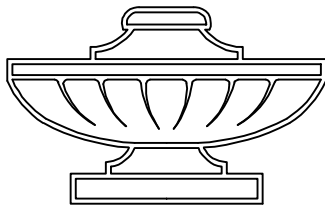

HEBREW 05 5X3



HEBREW 06 4X5

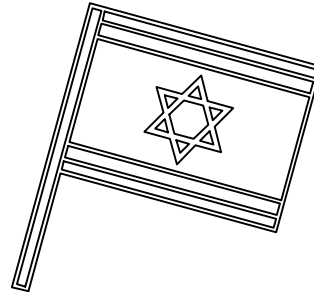

HEBREW 07 6X6

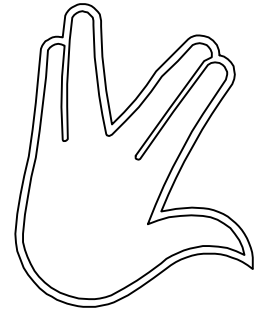

CROSS 08 3X3



HEBREW 09 6X6

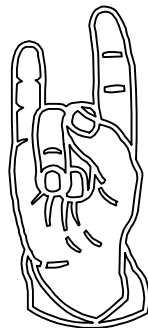

HEBREW 10 2X6

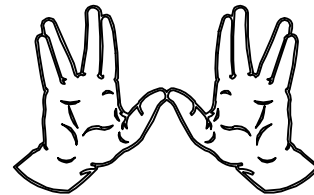

HEBREW 11 13X8



HEBREW 12 2X9



HEBREW 13 2X14



HEBREW 14 3X10



HEBREW 15 3X17



HEBREW 16 3X16

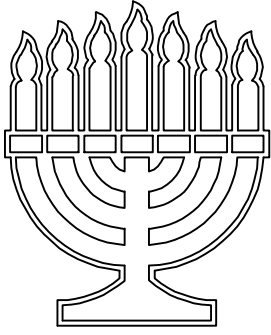

HEBREW 17 4X



HEBREW 18 4X5

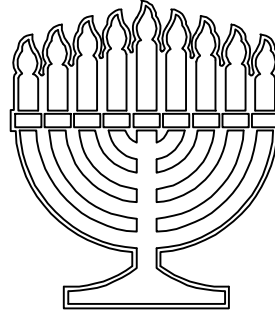

HEBREW 19 5X6



HEBREW 20 6X6



HEBREW 21 6X7

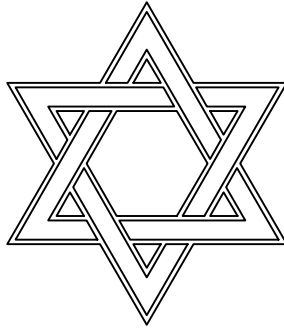

HEBREW 22 7X9

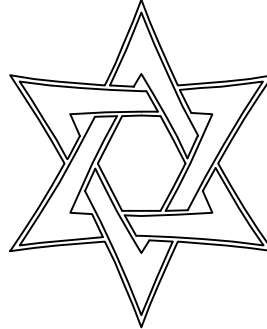

HEBREW 23 5X6



CROSS 24 5X6

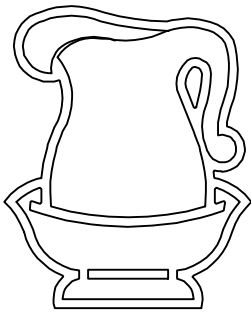

HEBREW 25 2X3



HEBREW 26 14X7

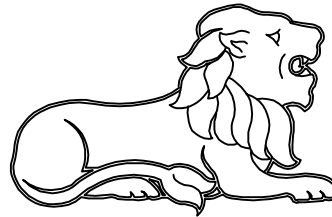

HEBREW 27 10X6

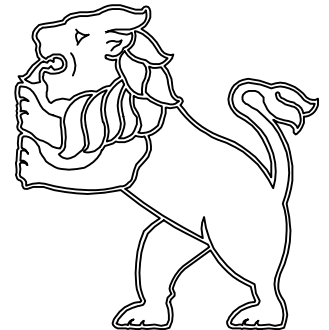

HEBREW 28 7X8

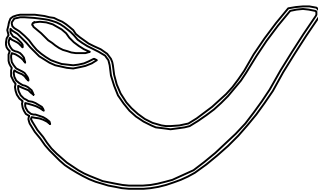

HEBREW 29 9X5

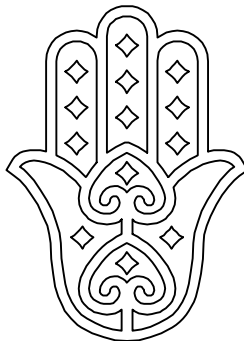

HEBREW 30 4X5



HEBREW 31 19X9

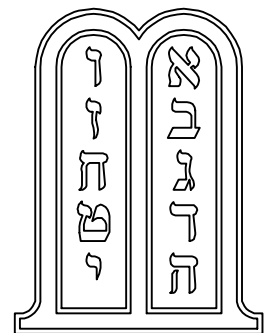

HEBREW 32 3X4



MILITARY 01 6X6



MILITARY 02 4X4

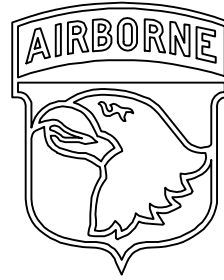

MILITARY 03 3 X4

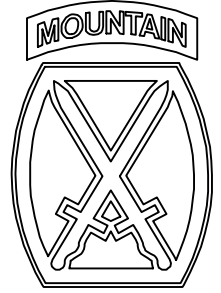

MILITARY 04 3X4



MILITARY 05 5X5



MILITARY 06 7X2



MILITARY 07 8X5



MILITARY 08 6X6

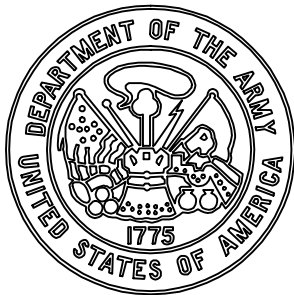

MILITARY 09 8X8



MILITARY 10 8X4



MILITARY 11 7X7



MILITARY 12 10X5



MILITARY 13 7X7



MILITARY 14 16 X 16

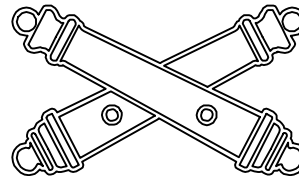

MILITARY 15 6X4



MILITARY 16 10X5



MILITARY 17 6X6

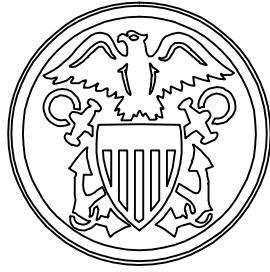

MILITARY 18 6X6



MILITARY 19 3X3



MILITARY 20 3X3



MILITARY 21 3X4



MILITARY 22 7X7

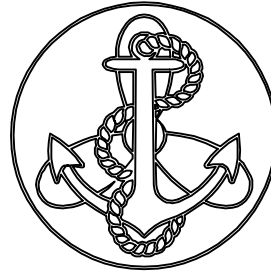

MILITARY 23 7X7



MILITARY 24 7X4



MILITARY 25 8X2

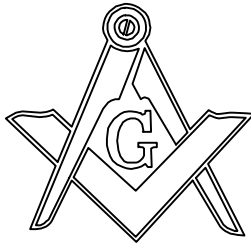

MILITARY 26 7X7



MILITARY 27 5X5



MILITARY 28 3X3



MILITARY 29 4X4



MILITARY 30 2X2

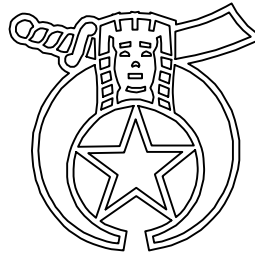

MILITARY 31 4X4

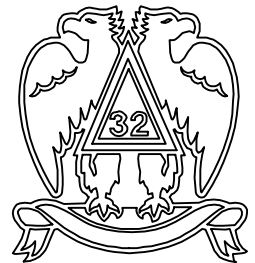

MILITARY 32 5X5



MILITARY 33 6X6



MILITARY 34 6X6



MILITARY 35 6X6



MILITARY 36 6X6



MILITARY 37 7X4



MILITARY 38 3X3

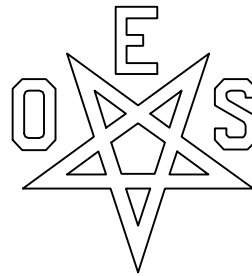

MILITARY 39 2X2

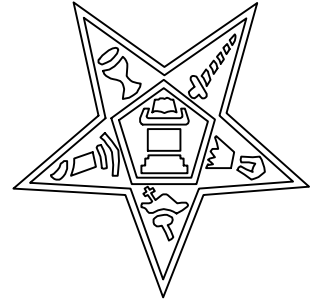

MILITARY 40 4X4



MILITARY 41 5X5

N.Y. STATE

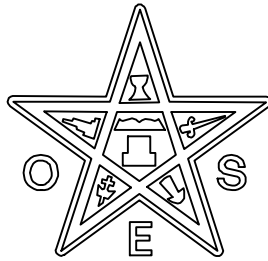

MILITARY 42 6X6



MILITARY 43 6X6

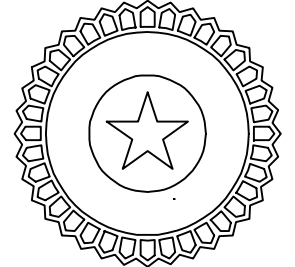

MILITARY 44 3X3

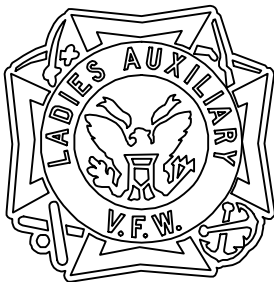

MILITARY 45 6X6



MILITARY 46 6X6

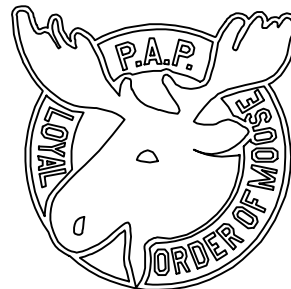

MILITARY 47 6X6



MILITARY 48 4X3



MILITARY 49 6X6



MILITARY 50 5X5

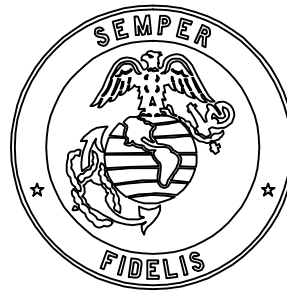

MILITARY 51 7X7



MILITARY 52 6X10



MILITARY 53 6X6



MILITARY 54 8X8



MILITARY 55 7X7

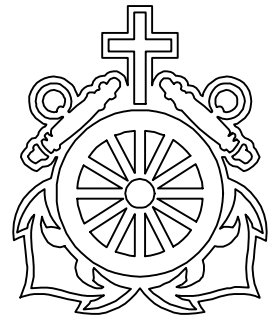

MILITARY 56 3X4



MILITARY 57 6X6



MILITARY 58 6X6



MILITARY 59 6X7



MILITARY 60 5X5



MILITARY 61 8X8

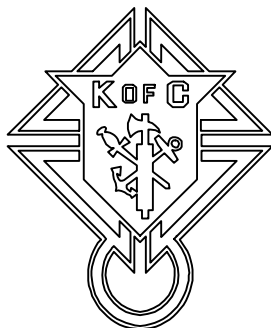

MILITARY 62 8X9

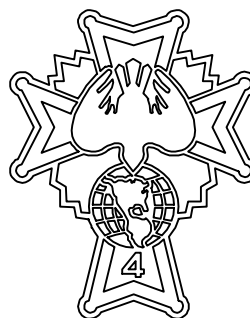

MILITARY 63 5X6



MILITARY 64 6X5

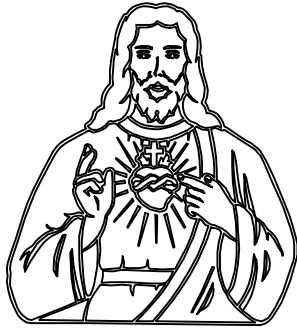

REL. FIG. 1 9X10



REL. FIG. 2 12X14



REL. FIG. 3 6X6



REL. FIG. 4 5X6



REL. FIG. 5 9X10

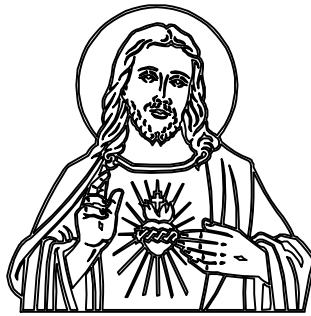

REL. FIG. 6 11X11



REL. FIG. 7 10X24



REL. FIG. 8 13X18



REL. FIG. 9 11X14



REL. FIG. 10 7X8



REL. FIG. 11 8X9



REL. FIG. 12 9X10



REL. FIG. 13 9X24



REL. FIG. 14 7X11



REL. FIG. 15 12X13



REL. FIG. 16 6X13



REL. FIG. 17 8X11



REL. FIG. 18 6X10



REL. FIG. 19 8X11



REL. FIG. 20 7X11



REL. FIG. 21 16X12



REL. FIG. 22 12X14



REL. FIG. 23 8X20



REL. FIG. 24 7X9



REL. FIG. 25 7X9



REL. FIG. 26 8X17



REL. FIG. 27 7X9



REL. FIG. 28 6X10



REL. FIG. 29 8X11



REL. FIG. 30 9X14



REL. FIG. 31 7X12



REL. FIG. 32 10X24



Lettering and Size Chart

Adams Granite Company, Inc.

Gerber Fonts

CONDENSE ROMAN
MODIFIED ROMAN
ROMAN NO. 2
F.O. MOD. ROMAN
F.O. CONDENSE ROMAN
CLASSIC ROMAN
PANEL LETTERS—SR
COMMON GOTHIC
ROUND RAISED
Artus Script
Monument Script
Irish Font
Jewish נגיד
Greek ΑΒΔΕΞ
Russian ABCDE
Royal Russian ABCDE
LOMBARDIC UNCIAL
MONUMENT UNCIAL
UNCIAL-SR
Old English- sr
Americana Bold
Antique Olive Bold
Antique Olive Med.

Gerber Fonts

Avant Extra Bold
Avant Garde
Baskerville
Baskerville Bold
Bembo Bold
Berling Bold
Blippo Bold
Breeze Script Ct.
Broadway Acct.
BROADWAY ENGRAVED
Brush Script
Casuallee Curstve Conn.
Caxton Bold
Century Bold
Century Bold Italic
Century Schoolbook
Clarendon Bold
Clarendon Med.
Commercial Script
DAVIDA ACCT.

Gerber Fonts

DeVienne Orn.
Dom Bold
ENGINEERING STANDARD
Eurostile Bold
Eurostile Med.
Flash Mod.
Folio Medium
Frank. Goth. X. Cond.
Franklin Gothic
Franklin Gothic Bold
Frestyle Script Bold
Friz Quadrata
Frutiger 65
Frutiger 75
Futura Bold
Futura Demi Bold
Futura Display
Gill Sans Bold
Goudy Bold
Goudy Extra Bold
Goudy Old Style

Gerber Fonts

Handel Gothic
Hawthorn
Helvet. Med.
Hobo Acct.
Horatio Med.
Jenson Medium
Kastiel Conn.
KOLOSS Acct.
Laser Connected
LoGriffe Acct.
Marker Acct.
MILITARY BLOCK
Mistral Conn.
MONUMENT BLOCK
MONUMENT BLOCK COND.
MONUMENT M.R.M. BOLD
MONUMENT R.M. BOLD
MONUMENT SHADOW
Murray Hill Bold
NARROW FULL BLOCK
Nelson Casual

Some Fonts Available
only in Certain Sizes

Gerber Fonts

Optima Medium
Optima Semi Bold
P.I. BARRAM
Palatino
Platino Italic
Park Avenue
PEIGNOT MEDIUM
Perpetua Bold
Perpetua Regular
Playbill Acct.
Pretorian
Raphael Acct.
Rickshaw Acct.
Rodeo Acct.
Sabon Bold Acct.
Serifa Acct.
Stand. Bold Cond.
Standard Ext. Med.
Standard Med.
STENCIL GOTHIC

Gerber Fonts

Stymie Extra Bold
Tiffany Heavy
Tiffany Med.
Times Bold
Times Bold Italic
Times Italic Acct.
Times New Rom.
Times New Roman-GSP
TINKER ACCT.
Triplett Ext. Bold
TTF Celtic Bold
TTF CELTIC HAND
TTF Script MS Bold
US GOV'T MON MKR
Univers 49
Univers 55
Univers 57
V.A.G. Acct. A.K.
Venus Acct.
VERMARCO
Verve Mod. Conn.
Victorian Acct.
Volta Bold
Zaph Chan. Bold

Slant Face Size Chart

WIDTH x HEIGHT	2", 3" NOSE	2", 4" NOSE	2", WESTERN
8" X 10"	9"	8.375"	11.625"
8" X 12"	10.75"	10"	13.375"
8" X 14"	12.5"	11.625"	15.25"
8" X 16"	14.25"	13.375"	17"
8" X 18"	16"	15.18"	19"
10" X 10"	10.625"	10"	12.75"
10" X 12"	12"	11.25"	14.375"
10" X 14"	13.5"	12.75"	16"
10" X 16"	15.5"	14.375"	17.875"
10" X 18"	17"	16"	19.75"
12" X 12"	13.5"	12.75"	15.625"
12" X 14"	15"	14.375"	17.25"
12" X 16"	16.625"	16.125"	18.875"
12" X 18"	18.375"	17.875"	20.5"

 Adams Granite Company, Inc.



www.adamsgranite.org

P.O. Box 126 Barre, VT 05641

Phone: 877-682-3267

Fax: 877-476-3027